



# Multifamily price book 15

Effective February 28, 2025  
Falcon, Glynn-Johnson, Ives, LCN,  
Schlage, and Von Duprin



**FALCON. ■ GLYNN-JOHNSON. ■ IVES. ■ LCN. ■ SCHLAGE ■ VON DUPRIN.**

This price list supersedes and cancels all previous price lists. Prices shown are subject to change without notice.

## Customer care

Our Customer Care Representatives are available for questions or assistance.

**877-671-7011**

### Customer service

Press **1**  
support@allegion.com

### Technical support

Press **2**

### For new projects or to locate an authorized distributor

Press **3**

## Placing orders

You can place orders with Allegion via the email listed below:  
Allegion\_Orders@allegion.com

## Sales support

support@allegion.com

## Administrative offices

### Allegion administrative office

11819 N. Pennsylvania St.  
Carmel, IN 46032  
[allegion.com/us](http://allegion.com/us)

## Request for quote

### Carolinas

(North Carolina, South Carolina, Virginia)  
[Carolinas.Quotes@allegion.com](mailto:Carolinas.Quotes@allegion.com)

### Central

(Illinois, Iowa, Kansas, Missouri, Nebraska)  
[Central.Quotes@allegion.com](mailto:Central.Quotes@allegion.com)

### Chicago

(Northern Illinois, Wisconsin)  
[Chicago.Quotes@allegion.com](mailto:Chicago.Quotes@allegion.com)

### Florida

[Florida.Quotes@allegion.com](mailto:Florida.Quotes@allegion.com)

### Metro New York

(Metro New York, Northern New Jersey)  
[Metro.Quotes@allegion.com](mailto:Metro.Quotes@allegion.com)

### Michigan

[Michigan.Quotes@allegion.com](mailto:Michigan.Quotes@allegion.com)

### Mid Atlantic North

(New York, Western Pennsylvania)  
[Mid.Atlantic.North.Quotes@allegion.com](mailto:Mid.Atlantic.North.Quotes@allegion.com)

### Mid Atlantic South

(Delaware, Eastern Pennsylvania, Maryland, Northern Virginia, Southern New Jersey, Washington DC)  
[Mid.Atlantic.South.Quotes@allegion.com](mailto:Mid.Atlantic.South.Quotes@allegion.com)

### Midwest

(Indiana, Kentucky, Ohio, West Virginia)  
[Midwest.Quotes@allegion.com](mailto:Midwest.Quotes@allegion.com)

### Mountain States

(Colorado, Idaho, Montana, Nevada, Utah, Wyoming)  
[Mtn.States.Quotes@allegion.com](mailto:Mtn.States.Quotes@allegion.com)

### New England

(Connecticut, Maine, Massachusetts, New Hampshire, Rhode Island, Vermont)  
[NewEngland.Quotes@allegion.com](mailto:NewEngland.Quotes@allegion.com)

### North Central

(Minnesota, North Dakota, South Dakota)  
[NorthCentral.Quotes@allegion.com](mailto:NorthCentral.Quotes@allegion.com)

### Northern California

[NoCal.Quotes@allegion.com](mailto:NoCal.Quotes@allegion.com)

### Northwest

(Alaska, Oregon, Washington)  
[Northwest.Quotes@allegion.com](mailto:Northwest.Quotes@allegion.com)

### South

(Alabama, Georgia, Louisiana, Mississippi, Tennessee)  
[South.Quotes@allegion.com](mailto:South.Quotes@allegion.com)

### Southern California

(Southern California, Hawaii)  
[SoCal.Quotes@allegion.com](mailto:SoCal.Quotes@allegion.com)

### Southwest

(Arizona, New Mexico)  
[Southwest.Quotes@allegion.com](mailto:Southwest.Quotes@allegion.com)

### Texas

(Arkansas, Texas, Oklahoma)  
[Texas.Quotes@allegion.com](mailto:Texas.Quotes@allegion.com)

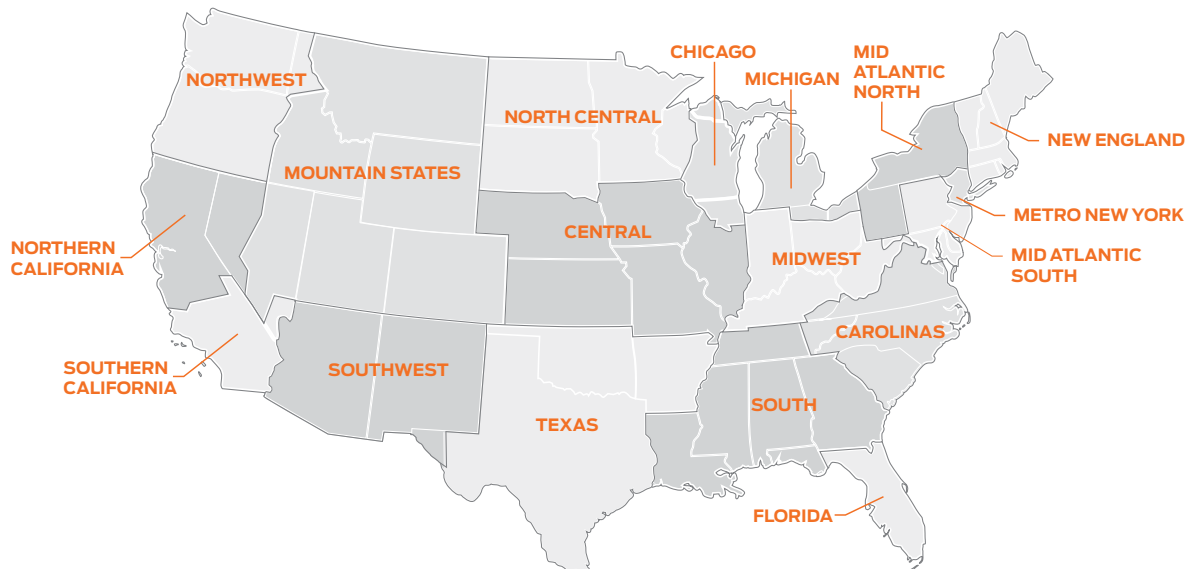

# Contents

## LOCKS

### Residential electronic locks

XE360™ Series wireless tubular lock ..... 5  
 XE360™ Series wireless mortise lock ..... 8  
 XE360™ Series wireless exit wide stile lock .. 11  
 Schlage Control® Mobile enabled smart  
 interconnect lock ..... 14  
 Schlage Control® Mobile enabled  
 smart deadbolt ..... 17  
 Schlage Control® Multifamily Residential  
 electronic locks – Top sellers ..... 19

### Residential mechanical locks

Schlage Residential F Series ..... 20  
 Schlage Residential J Series ..... 22  
 Schlage Residential B Series Deadbolt ..... 25  
 Schlage Residential J Series Deadbolt ..... 25  
 Schlage Full size construction core program 28  
 Schlage Cylinder and key stamping ..... 29  
 Schlage Keying charges ..... 29

### Commercial wireless electronic/ electrified locks, readers and devices

Schlage LE Mortise mobile enabled  
 wireless lock ..... 30  
 Schlage NDE Mobile enabled cylindrical  
 wireless lock ..... 47  
 Schlage CTE Engage™ single door controller 59  
 Schlage Residential electronics accessories 60  
 Schlage Electronic locking systems  
 and accessories ..... 61

### Commercial mechanical and electrified locks - Schlage and Falcon

Schlage B500 Series Deadbolt ..... 62  
 Schlage CS210 Interconnect lock ..... 63  
 Schlage L Series Mortise lock ..... 66  
 Schlage ND Series Cylindrical lock ..... 85  
 Schlage ALX Series Cylindrical lock ..... 93  
 Falcon MA Series Mortise lock ..... 99  
 Falcon T Series Cylindrical lock ..... 103  
 Falcon W Series Cylindrical lock ..... 107  
 Falcon D200 Medium duty deadbolt ..... 112  
 Falcon H2 Series Interconnected lock ..... 115  
 Falcon Cylinders ..... 118  
 Falcon Keys ..... 121  
 Falcon Construction core program ..... 123

## EXIT DEVICES

### Von Duprin

22 Series ..... 124  
 Auxiliary parts ..... 126  
 Electronics e-Strike ..... 126  
 98 Series ..... 127  
 35A Series ..... 127  
 Device options ..... 128  
 Device accessories ..... 129  
 Dummy touch bars ..... 129

### Falcon

24 Series ..... 130  
 25 Series ..... 134  
 19 Series ..... 140  
 1690/1790 Series ..... 144  
 1990/2090 Series ..... 146

## SURFACE DOOR CLOSERS

### LCN

1250 Series ..... 148  
 1260 Series ..... 148  
 1450 Series ..... 148  
 1460 Series ..... 149  
 4040XP Series ..... 149  
 4050A Series ..... 149  
 Parts and components ..... 150  
 Automatic operators ..... 151

### Falcon

General closer information ..... 152  
 SC60A Series ..... 155  
 SC70A Series ..... 156  
 SC80A Series ..... 157  
 SC90A Series ..... 158

## ARCHITECTURAL HARDWARE

### Ives

Hinges and pivots ..... 159  
 Pulls and plates ..... 161  
 Flush bolts and coordinators ..... 163  
 Latches and catches ..... 164  
 Stops ..... 166  
 Exterior and miscellaneous hardware ..... 168

### Schlage

Residential barn door hardware ..... 170  
 Residential sliding door hardware ..... 171

## OVERHEAD STOPS AND HOLDERS

### Glynn-Johnson

70 Series ..... 172  
 81 Series ..... 172  
 90 Series ..... 172  
 100 Series ..... 173  
 410 Series ..... 173  
 450 Series ..... 174

## HOW TO ORDER

### Locks

Schlage Residential ..... 175  
 Schlage Commercial ..... 176

### Commercial wireless electronic/ electrified locks, readers and devices

Schlage LE Mortise mobile enabled  
 wireless lock ..... 177  
 Schlage NDE Mobile enabled cylindrical  
 wireless lock ..... 179  
 Schlage CTE Engage™ single door controller 181

### Commercial mechanical locks

Schlage ND Series ..... 182  
 Schlage L Series ..... 183  
 Schlage ALX Series ..... 184  
 Falcon Commercial mechanical locks ..... 185

### Exit devices

Von Duprin Exit devices ..... 186  
 Falcon Exit devices ..... 187  
 Falcon Exit device trim ..... 188

### Surface door closers

LCN Surface door closers ..... 189  
 Falcon Surface door closers ..... 192

### Accessories

Glynn-Johnson Accessories ..... 194

# Where residential and commercial lever styles meet

Schlage, Falcon, and Von Duprin locks and exit lever designs allow for residential and common areas to match in style, whether that is contemporary, to transitional, to traditional. While the lever and trim names may differ between the various series below, you can have confidence that each lever design will coordinate into one of the lever suiting styles. Coordinate the lever designs below to create seamless transitions between residential and commercial areas.

## Contemporary

Minimalist lever design with clean lines



Latitude,  
Longitude, Solstice

## Contemporary/Transitional

Rounded, high-style lever design



Broadway,  
Boardwalk, M52

## Transitional/Traditional

Curved, tapered lever design



Jazz, Jupiter, Athens,  
Dover, Avalon, 07



Quantum, Sparta,  
Neptune, 17

## Traditional

Simplistic return-to-door lever design



Rhodes, Saturn, Marin,  
Elan, Dane, 06

	Contemporary	Contemporary/ Transitional	Transitional/Traditional	Traditional	
<b>Residential area locks</b>					
Schlage Control Smart Interconnected Lock - Grade 2	Latitude	Broadway	Jupiter, Jazz	Neptune	Elan
Schlage F Series cylindrical lock - Grade 2	Latitude	Broadway	Jazz	Jazz	Elan
Schlage J Series lock - Grade 3	Solstice	-	Dover	Dover	Marin
<b>Common area locks</b>					
Schlage LE mortise wireless lock - Grade 1	Latitude	M52	07	17	06
Schlage L Series mortise lock - Grade 1	Latitude	M52	07	17	06
Schlage NDE cylindrical wireless lock - Grade 1	Latitude	Broadway	Athens	Sparta	Rhodes
Schlage ND Series cylindrical lock - Grade 1	Latitude	Broadway	Athens	Sparta	Rhodes
Schlage CS210 interconnected lock - Grade 2	Latitude	Broadway	Jupiter	Neptune	Saturn
Falcon MA Series mortise lock - Grade 1	Latitude	Broadway	Avalon	Quantum	Dane
Falcon T Series cylindrical lock - Grade 1	Latitude	Broadway	Avalon	Quantum	Dane
Falcon W Series cylindrical lock - Grade 2	Latitude	Broadway	Avalon	Quantum	Dane
Falcon H2 Series interconnected lock - Grade 2	Latitude	Broadway	Avalon	Quantum	Dane
<b>Commercial exit devices and trim</b>					
Von Duprin 98/99 Series wide stile pushpad - Grade 1	Latitude	M52	07	17	06
Falcon 25 Series wide stile pushpad - Grade 1	Latitude	Broadway	Avalon	Quantum	Dane
Falcon 24 Series narrow stile pushpad - Grade 1	Latitude	Broadway	Avalon	Quantum	Dane

Note: Not all levers and trim are listed for the products mentioned in this price book. For the complete offering, contact your sales consultant.

## Policies and documents

The purchase of Allegion products is governed by the Allegion Authorized Seller Program.

For program terms and conditions, and other program details, please visit: [www.allegion.com/AuthorizedSeller](http://www.allegion.com/AuthorizedSeller).

For Warranty information, visit [us.allegion.com/warranty](http://us.allegion.com/warranty) or contact Customer Service at 877-671-7011.

## Sustainability

Allegion can provide sustainability documentation for select products, ensuring transparency and adherence to environmental standards and building certification programs such as LEED and Living Building Challenge. This documentation includes detailed information on the sustainable practices and materials used, helping you make informed decisions that align with your sustainability goals.

To view the full list of products with declarations, please visit: <https://us.allegion.com/en/resources/sustainability.html>

## XE360™ SERIES WIRELESS TUBULAR LOCK



XE360 Tubular Exterior  
with Latitude lever



XE360 Tubular Interior  
with Latitude lever

### Finish codes and descriptions

619	622	626
Satin Nickel (US15)	Matte Black (US19)	Satin Chrome (US26D)

The XE360™ Series is the next generation of wireless electronic lock from Schlage. Its sleek design offers customers a solution that looks as good as it performs—at an affordable price point. Schlage XE360 currently works within No-Tour or offline access control systems and is built to accommodate changing technologies. Credential support includes smart, Bluetooth and NFC mobile. The XE360 Series is available as tubular, mortise, mortise deadbolt, or exit trim. The open architecture design of the XE360 allows it to be managed by ENGAGE™ and other Allegion software or be integrated into popular physical access control and Proptech systems through Allegion's PACS Alliance program. This enables customers to choose what best fits their requirements now and in the future.

### Standard features

- Next level design inside and out
- Credential support includes Schlage MIFARE®, Bluetooth® and NFC mobile<sup>1</sup>
- Advanced encryption keeps data and communications safe
- Wireless configuration using connected smartphones or tablets
- No-Tour or offline system capacity
- Open architecture – interoperable and simple for software alliances to integrate
- Works seamlessly with other Schlage wireless locks, including Schlage Control®<sup>2</sup>
- Uniquely concealed key override standard on all locks

1. Use of mobile credential is dependent on availability of compatible mobile credential.  
2. Check with your Proptech or PACS provider for specific support.

### Mechanical specifications

Chassis	Tubular	Door range	1-3/4" (44mm)
Handing	On-site handing with included hex key	Construction	All-metal chassis and escutcheon; exterior polycarbonate elements
Latch	1" x 2-1/4" (25mm x 57mm); square and round corner faceplate; 1" (25mm) edge bore required	Levers	Zinc
Strike	Standard: 1-1/8" (29mm) lip, ANSI, 1-1/8" x 2-3/4" (29mm x 70mm), no box; Optional: Additional strike lip lengths and ANSI strike box available	Cylinder and keys	Schlage Classic C keyway, Conventional 6-pin cylinder with two keys
Strike width	Minimum 4-1/4" (108mm)	Certifications	ANSI/BHMA A156.02-2022 Grade 2 ANSI/BHMA A156.25-2023 Locked outdoor type ANSI/BHMA A156.5-2020
Backset	Standard: 2-3/4" (70mm), field adjustable to 2-3/8" (60mm)		

### Reader specifications

Credential technologies	Smart (13.56 MHz), Bluetooth Low Energy (LE) (2.4 GHz), and Near Field Communication (NFC)	Smart credential support	Secure application area: Schlage MIFARE Classic®, Schlage MIFARE® DESFire® EV1/EV2/EV3 CSN only: HID iCLASS®, HID iCLASS SE®, MIFARE Classic / DESFire
Read range	Smart: up to .5" Bluetooth® Low Energy: up to 15' NFC: mobile device dependent	Mobile credential support	Schlage Mobile Bluetooth Credential, Integrated PACS mobile credential with Bluetooth, Apple Wallet® NFC student ID and employee badge; Google Wallet™ NFC student ID and employee badge
Standards	ISO standard 15693 and ISO 14443		



619	622	626
US15	US19	US26D

### XE360™ SERIES WIRELESS TUBULAR LOCK

RESIDENTIAL ELECTRONIC

RESIDENTIAL MECHANICAL

COMMERCIAL WIRELESS ELECTRONIC

COMMERCIAL MECHANICAL/ELECTRIFIED

SELECT LOCK MODEL		
Description	Specify	Price (ea.)
Tubular	XE360-T	\$883.00

SELECT LOCK MODEL		
Description	Specify	Price adjustment
Offline – Toured and No-Tour compatible	OF	No charge

SELECT FUNCTION		
Description	Specify	Price adjustment
Indicator (LED indicator on interior assembly)	I	No charge
Button (Interior Push Button with LED indicator)	B	No charge

SELECT READER		
Description	Specify	Price adjustment
Smart/NFC Mobile (13.56 MHz) and Bluetooth® (2.4 GHz) Mobile Credential Support	SM	No charge

SELECT LEVER STYLE		
Description	Specify	Price adjustment
Broadway	BRW	No charge
Latitude	LAT	No charge
Neptune	NEP	No charge
Longitude Extended Length	LON-E	No charge

SELECT FINISH STYLE		
Description	Specify	Price adjustment
Satin Nickel	619	No charge
Matte Black	622	No charge
Satin Chrome	626	No charge

SELECT KEY CYLINDER		
Description	Specify	Price adjustment
Schlage Conventional, 6-pin	P6	No charge

SELECT KEYWAY		
Description	Specify	Price adjustment
Schlage Classic Obverse	C	No charge



619	622	626
US15	US19	US26D

### XE360™ SERIES WIRELESS TUBULAR LOCK

SELECT STRIKE		
Description	Specify	Price adjustment
Strike, 1-1/8" lip – Standard	A500-074	No charge
Strike, 1-1/2" lip	A500-077	No charge
Strike, 1-3/4" lip	A500-079	No charge
Strike, 2" lip	A500-081	No charge

SELECT DOOR THICKNESS		
Description	Specify	Price adjustment
1-3/4" Thick door	134	No charge

SELECT DOOR POSITION SWITCH		
Description	Specify	Price adjustment
Less door position switch – Standard	LLL	No charge

SELECT SOLD SEPARATE		
Description	Specify	Price (ea.)
Mount, XE360 Series Tubular	47709952	\$292.00
Condensation sealant kit (includes PCBA cover, backplate plugs, and gaskets for environmental robustness)	47870663	\$57.00
Door position switch	47467230	\$47.00

LOCKS

EXIT DEVICES

DOOR CLOSERS

ARCHITECTURAL HARDWARE

OVERHEAD STOPS & HOLDERS

HOW TO ORDER



### XE360™ SERIES WIRELESS MORTISE LOCK

#### Finish codes and descriptions

619	622	626
Satin Nickel (US15)	Matte Black (US19)	Satin Chrome (US26D)



XE360 Mortise Exterior with Broadway lever



XE360 Mortise Interior with Broadway lever

The XE360™ Series is the next generation of wireless electronic lock from Schlage. Its sleek design offers customers a solution that looks as good as it performs—at an affordable price point. Schlage XE360 currently works within No-Tour or offline access control systems and is built to accommodate changing technologies. Credential support includes smart, Bluetooth and NFC mobile. The XE360 Series is available as tubular, mortise, mortise deadbolt, or exit trim. The open architecture design of the XE360 allows it to be managed by ENGAGE™ and other Allegion software or be integrated into popular physical access control and Proptech systems through Allegion's PACS Alliance program. This enables customers to choose what best fits their requirements now and in the future.

#### Standard features

- Next level design inside and out
- Credential support includes Schlage MIFARE®, Bluetooth® and NFC mobile<sup>1</sup>
- Advanced encryption keeps data and communications safe
- Wireless configuration using connected smartphones or tablets
- No-Tour or offline system capacity
- Open architecture – interoperable and simple for software alliances to integrate
- Works seamlessly with other Schlage wireless locks, including Schlage Control®<sup>2</sup>
- Uniquely concealed key override standard on all locks

1. Use of mobile credential is dependent on availability of compatible mobile credential.  
 2. Check with your Proptech or PACS provider for specific support.

#### Mechanical specifications

Chassis	Mortise	Door range	1-3/4" (44mm)
Handing	On-site handing with included hex key	Construction	All-metal chassis and escutcheon; exterior polycarbonate elements
Latch	Standard: 3/4" (19mm) throw stainless steel latch bolt with anti-friction tongue	Levers	Zinc
Strike	Standard: 1-3/16" (30mm) curved lip, ANSI, 1-1/4" x 4-7/8" (32mm x 124mm); no box Optional: Additional strike lip lengths and ANSI strike box available	Cylinder and keys	Schlage Classic C keyway, Conventional 6-pin cylinder with two keys
Strike width	Minimum 4-1/2" (114mm)	Certifications	ANSI/BHMA A156.13-2022 ANSI/BHMA A156.25-2023 Locked outdoor type ANSI/BHMA A156.5-2020
Backset	2-3/4" (70mm)		

#### Reader specifications

Credential technologies	Smart (13.56 MHz), Bluetooth Low Energy (LE) (2.4 GHz), and Near Field Communication (NFC)	Smart credential support	Secure application area: Schlage MIFARE Classic®, Schlage MIFARE® DESFire® EV1/EV2/EV3
Read range	Smart: up to .5" Bluetooth® Low Energy: up to 15' NFC: mobile device dependent	Mobile credential support	CSN only: HID iCLASS®, HID iCLASS SE®, MIFARE Classic / DESFire Schlage Mobile Bluetooth Credential, Integrated PACS mobile credential with Bluetooth, Apple Wallet® NFC student ID and employee badge; Google Wallet™ NFC student ID and employee badge
Standards	ISO standard 15693 and ISO 14443		

RESIDENTIAL ELECTRONIC

RESIDENTIAL MECHANICAL

COMMERCIAL WIRELESS ELECTRONIC

COMMERCIAL MECHANICAL/ELECTRIFIED





619	622	626
US15	US19	US26D

XE360™ SERIES WIRELESS MORTISE LOCK

SELECT LOCK MODEL		
Description	Specify	Price (ea.)
Mortise	XE360-M	\$1,101.00

SELECT LOCK MODEL		
Description	Specify	Price adjustment
Offline – Toured and No-Tour compatible	OF	No charge

SELECT FUNCTION		
Description	Specify	Price adjustment
Indicator (LED indicator on interior assembly)	I	No charge
Button (Interior Push Button with LED indicator)	B	No charge
Deadbolt (Interior Thumbturn with LED indicator) – Mortise chassis with deadbolt included	D	\$104.00

SELECT READER		
Description	Specify	Price adjustment
Smart / NFC Mobile (13.56 MHz) and Bluetooth® (2.4 GHz) Mobile Credential Support	SM	No charge

SELECT LEVER STYLE		
Description	Specify	Price adjustment
Broadway	BRW	No charge
Latitude	LAT	No charge
Neptune	NEP	No charge
Longitude Extended Length	LON-E	No charge

SELECT FINISH		
Description	Specify	Price adjustment
Satin Nickel	619	No charge
Matte Black	622	No charge
Satin Chrome	626	No charge

SELECT KEY CYLINDER		
Description	Specify	Price adjustment
Schlage Conventional, 6-pin	P6	No charge

SELECT KEYWAY		
Description	Specify	Price adjustment
Schlage Classic Obverse	C	No charge



619	622	626
US15	US19	US26D

### XE360™ SERIES WIRELESS MORTISE LOCK

SELECT ARMOR FRONT		
Description	Specify	Price adjustment
Button and indicator 1-1/4" x 8" x 7/32"	09-663	No charge
Deadbolt 1-1/4" x 8" x 7/32"	09-666	No charge

SELECT STRIKE		
Description	Specify	Price adjustment
Mortise strike, 1-3/16" lip with screws – Standard	10-072	No charge

SELECT DOOR THICKNESS		
Description	Specify	Price adjustment
1-3/4" Thick door	134	No charge

SELECT DOOR POSITION SWITCH		
Description	Specify	Price adjustment
Less door position switch – Standard	LLL	No charge

SELECT SOLD SEPARATE		
Description	Specify	Price (ea.)
Mount, XE360 Series Mortise	47709953	\$292.00
Condensation sealant kit (includes PCBA cover, backplate plugs, and gaskets for environmental robustness)	47870663	\$57.00
Door position switch	47467230	\$47.00

RESIDENTIAL ELECTRONIC

RESIDENTIAL MECHANICAL

COMMERCIAL WIRELESS ELECTRONIC

COMMERCIAL MECHANICAL/ELECTRIFIED

## XE360™ SERIES WIRELESS EXIT WIDE STILE LOCK



XE360 Exit Exterior  
with Neptune lever



XE360 Exit Interior  
with Falcon Rim 25R  
(exit device sold separately)

### Finish codes and descriptions

619	622	626
Satin Nickel (US15)	Matte Black (US19)	Satin Chrome (US26D)

The XE360™ Series is the next generation of wireless electronic lock from Schlage. Its sleek design offers customers a solution that looks as good as it performs—at an affordable price point. Schlage XE360 currently works within No-Tour or offline access control systems and is built to accommodate changing technologies. Credential support includes smart, Bluetooth and NFC mobile. The XE360 Series is available as tubular, mortise, mortise deadbolt, or exit trim. The open architecture design of the XE360 allows it to be managed by ENGAGE™ and other Allegion software or be integrated into popular physical access control and Proptech systems through Allegion’s PACS Alliance program. This enables customers to choose what best fits their requirements now and in the future.

### Standard features

- Next level design inside and out
- Credential support includes Schlage MIFARE®, Bluetooth® and NFC mobile<sup>1</sup>
- Advanced encryption keeps data and communications safe
- Wireless configuration using connected smartphones or tablets
- No-Tour or offline system capacity
- Open architecture – interoperable and simple for software alliances to integrate
- Works seamlessly with other Schlage wireless locks, including Schlage Control®<sup>2</sup>
- Uniquely concealed key override standard on all locks

1. Use of mobile credential is dependent on availability of compatible mobile credential.  
2. Check with your Proptech or PACS provider for specific support.

### Mechanical specifications

Chassis	Exit trim, wide stile	Construction	All-metal chassis and escutcheon; exterior polycarbonate elements
Handing	On-site handing with included hex key	Cylinder and keys	Schlage Classic C keyway, Conventional 6-pin cylinder with two keys
Latch	Defined by exit device	Certifications	ANSI/BHMA A156.13-2020 Grade 1 ANSI/BHMA A156.25-2023 Locked outdoor type ANSI/BHMA A156.5-2020
Strike	Defined by exit device		
Strike width	Minimum 4-1/4" (108mm)		
Backset	Defined by exit device		
Door range	1-3/4" (44mm)		
Levers	Zinc		

### Reader specifications

Credential technologies	Smart (13.56 MHz), Bluetooth Low Energy (LE) (2.4 GHz), and Near Field Communication (NFC)	Smart credential support	Secure application area: Schlage MIFARE Classic®, Schlage MIFARE® DESFire® EV1/EV2/EV3 CSN only: HID iCLASS®, HID iCLASS SE®, MIFARE Classic / DESFire
Read range	Smart: up to .5" Bluetooth® Low Energy: up to 15' NFC: mobile device dependent	Mobile credential support	Schlage Mobile Bluetooth Credential, Integrated PACS mobile credential with Bluetooth, Apple Wallet® NFC student ID and employee badge; Google Wallet™ NFC student ID and employee badge
Standards	ISO standard 15693 and ISO 14443		



619	622	626
US15	US19	US26D

## XE360™ SERIES WIRELESS EXIT WIDE STILE LOCK

SELECT LOCK MODEL		
Description	Specify	Price (ea.)
Exit Trim with Wide Escutcheon	XE360-EW	\$1,434.00

SELECT EXIT ADAPTER		
Description	Specify	Price adjustment
Falcon 25 Rim	25R	No charge
Falcon 25 Surface Vertical Rod	25S	No charge
Von Duprin 98/99 or XP98/99 Rim	99R	No charge
Von Duprin 98/99 Surface Vertical Rod	99S	No charge
Von Duprin 22 Rim	22R	No charge
Von Duprin 22 Surface Vertical Rod	22S	No charge
Less Exit Adapter	LLL	-\$103.00

SELECT LOCK MODEL		
Description	Specify	Price adjustment
Offline – Toured and No-Tour compatible	OF	No charge

SELECT FUNCTION		
Description	Specify	Price adjustment
Indicator (LED indicator on interior assembly)	I	No charge
Button (Interior Push Button with LED indicator)	B	No charge

SELECT READER		
Description	Specify	Price adjustment
Smart / NFC Mobile (13.56 MHz) and Bluetooth® (2.4 GHz) Mobile Credential Support	SM	No charge

SELECT LEVER STYLE		
Description	Specify	Price adjustment
Broadway	BRW	No charge
Latitude	LAT	No charge
Neptune	NEP	No charge
Longitude Extended Length	LON-E	No charge

SELECT FINISH		
Description	Specify	Price adjustment
Satin Nickel	619	No charge
Matte Black	622	No charge
Satin Chrome	626	No charge

RESIDENTIAL ELECTRONIC

RESIDENTIAL MECHANICAL

COMMERCIAL WIRELESS ELECTRONIC

COMMERCIAL MECHANICAL/ELECTRIFIED



619	622	626
US15	US19	US26D

XE360™ SERIES WIRELESS EXIT WIDE STILE LOCK

SELECT KEY CYLINDER		
Description	Specify	Price adjustment
Schlage Conventional, 6-pin	P6	No charge

SELECT KEYWAY		
Description	Specify	Price adjustment
Schlage Classic Obverse	C	No charge

SELECT DOOR THICKNESS		
Description	Specify	Price adjustment
1-3/4" Thick door	134	No charge

SELECT DOOR POSITION SWITCH		
Description	Specify	Price adjustment
Less door position switch – Standard	LLL	No charge

SELECT SOLD SEPARATE		
Description	Specify	Price (ea.)
Mount, XE360 Series Exit Trim, for Falcon 25 rim (use Falcon 25 rim center case and center case cover kits to complete installation)	47709954	\$292.00
Condensation sealant kit (includes PCBA cover, backplate plugs, and gaskets for environmental robustness)	47870662	\$57.00
Door position switch	47467230	\$47.00
Exit device decorative plate kit (exterior: 13.87" x 3.75"; interior: 12.75" x 3.75")	47679797	\$51.00



619	622	625	626	716
US15	US19	US26	US26D	643e

SCHLAGE CONTROL® MOBILE ENABLED SMART INTERCONNECT LOCKS



FE410 with Greenwich trim with Broadway lever

FE410 with Addison trim with Accent lever

Finish codes and descriptions<sup>1</sup>

619	622	625	626	716
Satin Nickel (US15)	Matte Black (US19)	Bright Chrome (US26)	Satin Chrome (US26D)	Aged Bronze (643e)

1. Non-Standard finishes are not available. Available in split finish and/or split lever options for no additional charge.

Standard features

- Keyless, no cylinder design
- Modern credentials – smart credential and/or phone as key
- Wireless freedom – control and program by phone
- Up to 500 users per lock
- Audit trail reports up to 1,000 events
- Fits standard door prep
- 1 year battery life with BLE mobile credential capability enabled
- 1.5 year battery life without BLE mobile credential capability enabled

- Full suiting with Schlage mechanical locks
- Single motion egress
- ADA compliant design
- Uses ENGAGE™ Technology
- See page 19 for information on the MT20W Credential enrollment reader



Specifications

Latch	1" x 2-1/4" square and round corner faceplate (square corner standard, round corner included in package) 1" edge bore required	Stile width	Minimum 4-1/2" stile for 2-3/8" backset, minimum 5" stile for 2-3/4"
Strike	1-1/8" x 2-3/4", square corner, no box, latch strike	Return to door	Saturn (SAT), Neptune (NEP), Boardwalk (BRK), and Longitude (LON) are return to door code compliant
Backset	Adjustable backset, fits 2-3/8" to 2-3/4" backsets	Center to center	Fits 4" or 5-1/2" center to center door preps -orderable options (Please specify when ordering.)
Door range	1-3/8" to 1-3/4" (thick door kit available – up to 2")	Certifications	90-minute UL Listed A 156.12 Grade 2 ANSI/BHMA certified; Canada UL 20-minute wood door rated. Approved for use where the exterior escutcheon only is exposed to the outdoors.
Battery	4-AA batteries included, (If loss of battery power occurs, a 9V battery can be used to jump start the lock and provide access with an assigned credential.)		
Construction	All-metal chassis and escutcheons		
Bore	2-1/8"		
Credentials	Supports Schlage MIFARE Classic®, Schlage Mobile Access Credential, Schlage DESFire® EV1 and Schlage DESFire® EV3 (sold separately). Please refer to the Credential Section of the Allegion Electronic Security Price Book.		

1. SELECT LOCK MODEL

Description	Specify	Price (ea.)
Schlage Control® Mobile enabled smart interconnect, UL Listed, 90 minutes	FE410F	\$988.00

2. SELECT DESIGN STYLE (TRIM)

Description	Specify	Price adjustment
Addison	ADD	No charge
Greenwich	GRW	No charge

3. SELECT INTERCONNECT TYPE

Description	Specify	Price adjustment
For doors with 4" bore hole spacing (40)	4"	No charge
For doors with 5-1/2" bore hole spacing (55)	5-1/2"	No charge

RESIDENTIAL ELECTRONIC

RESIDENTIAL MECHANICAL

COMMERCIAL WIRELESS ELECTRONIC

COMMERCIAL MECHANICAL/ELECTRIFIED



619	622	625	626	716
US15	US19	US26	US26D	643e

SCHLAGE CONTROL® MOBILE ENABLED SMART INTERCONNECT LOCKS

4. DESIGN – SELECT LEVER STYLE AND FINISH					
Style / Description	619	622	625	626	716
ACC / Accent	■	■	■	■	■
VLA / Avila	■		■	■	■
BRW / Broadway	■	■	■	■	■
BRK / Boardwalk	■	■	■	■	■
ELA / Elan	■	■	■	■	■
JAZ / Jazz	■	■	■	■	■
JUP / Jupiter	■	■	■	■	■
LAT / Latitude	■	■	■	■	■
LON / Longitude	■	■	■	■	■
MNH / Manhattan	■		■	■	
NEP / Neptune	■	■	■	■	■
NBK / Northbrook	■				
SAC / Sacramento	■		■	■	■
SAT / Saturn	■	■	■	■	■

LATCH		
Description	Specify	Price (ea.)
Combo latch, Dual option (sq + rd), Non UL bolt, UL latch – Standard	12-356	Not sold separately

HANDING		
Description	Specify	Price (ea.)
Can be changed to Right handed in the field – Standard	Left	No charge

DECO TRIM		
Description	Specify	Price (ea.)
ADD or GRW depending on which style is selected above – Standard	06-219	No charge

STRIKE COMBINATIONS		
Description	Specify	Price (ea.)
Combo strike, square corner (10-094 and 10-026) – Standard	10-152	No charge
10-094 and 10-001	10-151	
10-116 and 10-027	473344383	
10-092 and 10-027	10-123	
10-095 and 10-027	10-124	



619	622	625	626	716
US15	US19	US26	US26D	643e

SCHLAGE CONTROL® MOBILE ENABLED SMART INTERCONNECT LOCKS

DEADBOLT STRIKE OPTIONS		
Description	Specify	Price (ea.)
Square corner strike, 1-1/8" x 2-3/4" – Standard	10-094	\$17.80
1/4" Radius round corner, full lip, no box, 1-5/8" x 2-1/4"	10-092	\$11.40
Square corner, full lip, no box, 1-5/8" x 2-1/4"	10-095	\$11.00
Metal dust box with screws	10-112	\$17.70

DEADLATCH STRIKE OPTIONS		
Description	Specify	Price (ea.)
Square corner, full lip, no box, 1-5/8" x 2-1/4" – Standard	10-026	\$11.20
Square corner, T-strike, box, 1-1/8" x 2-3/4"	10-001	\$9.50
1/4" Radius round corner, full lip, no box, 1-5/8" x 2-1/4"	10-027	\$11.20

THICK DOOR KIT		
Description	Specify	Price (ea.)
For doors between 1-3/4" and 2"	47244555	\$34.00

The Schlage Control® interconnect lock uses the same Thick Door Kit as the deadbolt. However, due to the latch assembly it should only be used on doors between 1-3/4" and 2".

SCREW PACKS	Available finishes											
	605	606	612	613	619	622	625	626	629	630	716	
	N/A	N/A	N/A	N/A	▪	▪	▪	▪	N/A	N/A	▪	
Description	Specify										Price (ea.)	
	Part number	Finish										
Security screws – Optional security Torx® screws	47250323	.[Finish]										\$10.00
FE410 Screw pack	47275372	.[Finish]										\$10.00

RESIDENTIAL ELECTRONIC

RESIDENTIAL MECHANICAL

COMMERCIAL WIRELESS ELECTRONIC

COMMERCIAL MECHANICAL/ELECTRIFIED



619	622	625	626	716
US15	US19	US26	US26D	643e

## SCHLAGE CONTROL® MOBILE ENABLED SMART DEADBOLT



BE467 Greenwich (GRW)

BE467 Addison (ADD)

**Finish codes and descriptions<sup>1</sup>**

619	622	625	626	716
Satin Nickel (US15)	Matte Black (US19)	Bright Chrome (US26)	Satin Chrome (US26D)	Aged Bronze (643e)

1. Non-Standard finishes are not available. Available in split finish and/or split lever options for no additional charge.

**PRODUCT IDENTIFICATION**

BE	467	F
Lock	Function	90 Minute UL

**Standard features**

- Keyless, no cylinder design
- Modern credentials — smart credential and/or phone as key
- Wireless freedom — control and program by phone
- Up to 500 users per lock
- Audit trail reports up to 1,000 events
- Fits standard door prep
- 1 year battery life with BLE mobile credential capability enabled
- 1.5 year battery life without BLE mobile credential capability enabled
- Full suiting with Schlage decorative mechanical locks
- ADA compliant design
- Uses ENGAGE™ Technology
- See page 19 for information on the MT20W Credential enrollment reader

**Specifications**

Latch	1" x 2-1/4" square and round corner faceplate (round corner standard, square corner included in package) 1" edge bore required	Bore	2-1/8"
Strike	1-1/8" x 2-3/4", round corner, no box, latch strike	Credentials	Supports Schlage MIFARE Classic®, Schlage Mobile Access Credential, Schlage DESFire® EV1 and Schlage DESFire® EV3 (sold separately). Please refer to the Credential Section of the Allegion Electronic Security Price Book.
Backset	Adjustable backset, fits 2-3/8" to 2-3/4" backsets	Stile width	Minimum 4-1/2" stile for 2-3/8" backset, Minimum 5" stile for 2-3/4"
Door range	1-3/8" to 1-3/4" (thick door kit available – up to 2-1/4")	Certifications	90-minute UL Listed A 156.36 Grade 2 ANSI/BHMA certified; Canada UL 20-minute wood door rated. Approved for use where the exterior escutcheon only is exposed to the outdoors.
Hole distance	Minimum 4" center-to-center distance between cross bore holes		
Battery	4-AA batteries included, (If loss of battery power occurs, a 9V battery can be used to jump start the lock and provide access with an assigned credential.)		
Construction	All-metal chassis and escutcheons		



619	622	625	626	716
US15	US19	US26	US26D	643e

## SCHLAGE CONTROL® MOBILE ENABLED SMART DEADBOLT

1. SELECT LOCK MODEL		
Description	Specify	Price (ea.)
Schlage Control® Mobile enabled smart deadbolt, UL Listed, 90 minutes	BE467F	\$668.00

2. SELECT DESIGN STYLE (TRIM)		
Description	Specify	Price adjustment
Addison	ADD	No charge
Greenwich	GRW	No charge

3. SELECT FINISH STYLE		
Description	Specify	Price adjustment
Satin Nickel	619	No charge
Matte Black	622	No charge
Bright Chrome	625	No charge
Satin Chrome	626	No charge
Aged Bronze	716	No charge

LATCH		
Description	Specify	Price (ea.)
BE467F 90 Min UL Deadbolt latch dual option (sq+rd) – Standard	12-398	Not sold separately

BE467F STRIKE OPTIONS		
Description	Specify	Price adjustment
Round corner strike, 1-1/8" x 2-3/4" – Standard	10-116	No charge
Square corner strike, 1-1/8" x 2-3/4"	10-094	No charge
Square corner full lip strike, 1-5/8" x 2-1/4" (Lip length: 1-1/8")	10-095	No charge
Round corner full lip strike, 1-5/8" x 2-1/4" (Lip length: 1-1/8")	10-092	No charge

THICK DOOR KIT		
Description	Specify	Price (ea.)
For doors between 1-3/4" and 2-1/4"	47244555	\$34.00

The Schlage Control® deadbolt uses the same Thick Door Kit as the Interconnect. However, due to the differences in latch assemblies, the deadbolt can accommodate doors up to 2-1/4" in thickness.

SCREW PACKS	Available finishes										
	605	606	612	613	619	622	625	626	629	630	716
Description	Specify		Price (ea.)								
	Part number		Finish								
Security screws – Optional security Torx® screws	47250323		.[Finish]								
FE410 Screw pack	47275372		.[Finish]								

RESIDENTIAL ELECTRONIC

RESIDENTIAL MECHANICAL

COMMERCIAL WIRELESS ELECTRONIC

COMMERCIAL MECHANICAL/ELECTRIFIED

619	622	625	626	716
US15	US19	US26	US26D	643e

## ELECTRONIC LOCKING SYSTEMS



Greenwich (GRW)

Addison (ADD)

SCHLAGE CONTROL® SMART LOCKS – TOP SELLERS					
Product	BHMA Finish	Latch	Strike	Lever style	Price (ea.)
BE467F GRW	619	12-398	10-116	N/A	\$668.00
BE467F GRW	626	12-398	10-116	N/A	\$668.00
BE467F ADD	619	12-398	10-116	N/A	\$668.00
BE467F ADD	626	12-398	10-116	N/A	\$668.00
FE410F GRW	619	12-356	10-152	Latitude	\$988.00
FE410F GRW	626	12-356	10-152	Latitude	\$988.00
FE410F ADD	619	12-356	10-152	Latitude	\$988.00
FE410F ADD	626	12-356	10-152	Latitude	\$988.00

Note: FE410 locks are 5.5" center-to-center.

SCHLAGE SMART CREDENTIALS				
Product	Type	Description	Min. Order	Price (ea.)
9651	Keyfob	Schlage MIFARE Classic Smart Card 1K bit keyfob	50	\$10.10
9651T	Thin keyfob	Schlage MIFARE Classic Smart Card 1K bit thin keyfob	50	\$10.30
8540	Card	Schlage MIFARE DESFire EV1 Smart Card 2K byte / 16k bit ISO Glossy White	100	\$10.40
8543	Card	Schlage MIFARE DESFire EV3 4K byte/32K bit ISO Glossy White	100	\$10.40
8643T	Thin keyfob	Schlage MIFARE DESFire EV3 4K/32K bit thin keyfob	50	\$10.80

Note: 125 kHz Proximity credentials and MIFARE DESFIRE EV2 credentials are not compatible.

MULTI-TECH TECHNOLOGY CREDENTIALS				
Product	Type	Description	Min. Order	Price (ea.)
9691T	Thin keyfob	Proximity and Schlage MIFARE Classic Smart Card combo 1K byte/8K bit ISO thin keyfob	50	\$13.60
8843T	Thin keyfob	Proximity and Schlage MIFARE DESFire EV3 4K byte/32K bit thin keyfob	50	\$16.30

CREDENTIAL ENROLLMENT READER		
Product	Description	Price (ea.)
MT20W	Used to read and write to smart credentials within the ENGAGE™ Technology access control platform (For use with Schlage Control® Smart Locks)	\$820.00



619	622	625	626	716
US15	US19	US26	US26D	643e

## SCHLAGE RESIDENTIAL LOCKS

### Residential F Series

#### F - Lock



Elan (ELA)

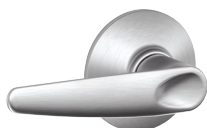

Jazz (JAZ)



Latitude (LAT)



Broadway (BRW)

Function	Description	Lever style	Finish	Latch	Strike	Cylinder	Price (ea.)
F10	Passage	ELA	619	16-080	10-027	N/A	\$74.00
F40	Privacy	ELA	619	16-080	10-027	N/A	\$80.00
F170	Dummy	ELA	619	N/A	N/A	N/A	\$40.00
F10	Passage	ELA	622	16-080	10-027	N/A	\$74.00
F40	Privacy	ELA	622	16-080	10-027	N/A	\$80.00
F170	Dummy	ELA	622	N/A	N/A	N/A	\$40.00
F10	Passage	ELA	625	16-080	10-027	N/A	\$74.00
F40	Privacy	ELA	625	16-080	10-027	N/A	\$80.00
F170	Dummy	ELA	625	N/A	N/A	N/A	\$40.00
F10	Passage	ELA	626	16-080	10-027	N/A	\$74.00
F40	Privacy	ELA	626	16-080	10-027	N/A	\$80.00
F170	Dummy	ELA	626	N/A	N/A	N/A	\$40.00
F10	Passage	ELA	716	16-080	10-027	N/A	\$74.00
F40	Privacy	ELA	716	16-080	10-027	N/A	\$80.00
F170	Dummy	ELA	716	N/A	N/A	N/A	\$40.00
F10	Passage	JAZ	619	16-080	10-027	N/A	\$74.00
F40	Privacy	JAZ	619	16-080	10-027	N/A	\$80.00
F170	Dummy	JAZ	619	N/A	N/A	N/A	\$40.00
F10	Passage	JAZ	622	16-080	10-027	N/A	\$74.00
F40	Privacy	JAZ	622	16-080	10-027	N/A	\$80.00
F170	Dummy	JAZ	622	N/A	N/A	N/A	\$40.00
F10	Passage	JAZ	625	16-080	10-027	N/A	\$74.00
F40	Privacy	JAZ	625	16-080	10-027	N/A	\$80.00
F170	Dummy	JAZ	625	N/A	N/A	N/A	\$40.00
F10	Passage	JAZ	626	16-080	10-027	N/A	\$74.00
F40	Privacy	JAZ	626	16-080	10-027	N/A	\$80.00
F170	Dummy	JAZ	626	N/A	N/A	N/A	\$40.00
F10	Passage	JAZ	716	16-080	10-027	N/A	\$74.00
F40	Privacy	JAZ	716	16-080	10-027	N/A	\$80.00
F170	Dummy	JAZ	716	N/A	N/A	N/A	\$40.00
F10	Passage	LAT	619	16-080	10-027	N/A	\$72.00
F40	Privacy	LAT	619	16-080	10-027	N/A	\$75.00
F170	Dummy	LAT	619	N/A	N/A	N/A	\$38.00
F10	Passage	LAT	622	16-080	10-027	N/A	\$72.00
F40	Privacy	LAT	622	16-080	10-027	N/A	\$75.00
F170	Dummy	LAT	622	N/A	N/A	N/A	\$38.00
F10	Passage	LAT	625	16-080	10-027	N/A	\$72.00

619	622	625	626	716
US15	US19	US26	US26D	643e

## SCHLAGE RESIDENTIAL LOCKS

### Residential F Series

#### F - Lock



Elan (ELA)



Jazz (JAZ)



Latitude (LAT)



Broadway (BRW)

Function	Description	Lever style	Finish	Latch	Strike	Cylinder	Price (ea.)
F40	Privacy	LAT	625	16-080	10-027	N/A	\$75.00
F170	Dummy	LAT	625	N/A	N/A	N/A	\$38.00
F10	Passage	LAT	626	16-080	10-027	N/A	\$72.00
F40	Privacy	LAT	626	16-080	10-027	N/A	\$75.00
F170	Dummy	LAT	626	N/A	N/A	N/A	\$38.00
F10	Passage	LAT	716	16-080	10-027	N/A	\$72.00
F40	Privacy	LAT	716	16-080	10-027	N/A	\$75.00
F170	Dummy	LAT	716	N/A	N/A	N/A	\$38.00
F10	Passage	BRW	619	16-080	10-027	N/A	\$74.00
F40	Privacy	BRW	619	16-080	10-027	N/A	\$80.00
F170	Dummy	BRW	619	N/A	N/A	N/A	\$40.00
F10	Passage	BRW	622	16-080	10-027	N/A	\$74.00
F40	Privacy	BRW	622	16-080	10-027	N/A	\$80.00
F170	Dummy	BRW	622	N/A	N/A	N/A	\$40.00
F10	Passage	BRW	625	16-080	10-027	N/A	\$74.00
F40	Privacy	BRW	625	16-080	10-027	N/A	\$80.00
F170	Dummy	BRW	625	N/A	N/A	N/A	\$40.00
F10	Passage	BRW	626	16-080	10-027	N/A	\$74.00
F40	Privacy	BRW	626	16-080	10-027	N/A	\$80.00
F170	Dummy	BRW	626	N/A	N/A	N/A	\$40.00
F10	Passage	BRW	716	16-080	10-027	N/A	\$74.00
F40	Privacy	BRW	716	16-080	10-027	N/A	\$80.00
F170	Dummy	BRW	716	N/A	N/A	N/A	\$40.00



619	622	625	626	716
US15	US19	US26	US26D	643e

## SCHLAGE RESIDENTIAL LOCKS

### Residential J Series

#### J - Lock



Dover (DOV)



Marin (MAR)



Solstice (SOL)



Solstice (SOL)  
Collins Rose



Broadway (BRW)



Broadway (BRW)  
Collins Rose

Function	Description	Lever style	Finish	Latch	Strike	Cylinder	Price (ea.)
J10	Passage	SOL	619	16-254	10-101	N/A	\$56.00
J40	Privacy	SOL	619	16-254	10-101	N/A	\$63.00
J170	Dummy	SOL	619	N/A	N/A	N/A	\$31.00
J10	Passage	SOL	622	16-254	10-101	N/A	\$56.00
J40	Privacy	SOL	622	16-254	10-101	N/A	\$63.00
J170	Dummy	SOL	622	N/A	N/A	N/A	\$31.00
J10	Passage	SOL	625	16-254	10-101	N/A	\$56.00
J40	Privacy	SOL	625	16-254	10-101	N/A	\$63.00
J170	Dummy	SOL	625	N/A	N/A	N/A	\$31.00
J10	Passage	SOL	626	16-254	10-101	N/A	\$56.00
J40	Privacy	SOL	626	16-254	10-101	N/A	\$63.00
J170	Dummy	SOL	626	N/A	N/A	N/A	\$31.00
J10	Passage	SOL	716	16-254	10-101	N/A	\$56.00
J40	Privacy	SOL	716	16-254	10-101	N/A	\$63.00
J170	Dummy	SOL	716	N/A	N/A	N/A	\$31.00
J10	Passage	SOL/COL	619	16-254	10-101	N/A	\$68.00
J40	Privacy	SOL/COL	619	16-254	10-101	N/A	\$71.00
J170	Dummy	SOL/COL	619	N/A	N/A	N/A	\$36.00
J10	Passage	SOL/COL	622	16-254	10-101	N/A	\$68.00
J40	Privacy	SOL/COL	622	16-254	10-101	N/A	\$71.00
J170	Dummy	SOL/COL	622	N/A	N/A	N/A	\$36.00
J10	Passage	SOL/COL	625	16-254	10-101	N/A	\$68.00
J40	Privacy	SOL/COL	625	16-254	10-101	N/A	\$71.00
J170	Dummy	SOL/COL	625	N/A	N/A	N/A	\$36.00
J10	Passage	SOL/COL	626	16-254	10-101	N/A	\$68.00
J40	Privacy	SOL/COL	626	16-254	10-101	N/A	\$71.00
J170	Dummy	SOL/COL	626	N/A	N/A	N/A	\$36.00
J10	Passage	SOL/COL	716	16-254	10-101	N/A	\$68.00
J40	Privacy	SOL/COL	716	16-254	10-101	N/A	\$71.00
J170	Dummy	SOL/COL	716	N/A	N/A	N/A	\$36.00
J10	Passage	BRW	619	16-254	10-101	N/A	\$56.00
J40	Privacy	BRW	619	16-254	10-101	N/A	\$63.00
J170	Dummy	BRW	619	N/A	N/A	N/A	\$31.00
J10	Passage	BRW	622	16-254	10-101	N/A	\$56.00
J40	Privacy	BRW	622	16-254	10-101	N/A	\$63.00
J170	Dummy	BRW	622	N/A	N/A	N/A	\$31.00
J10	Passage	BRW	625	16-254	10-101	N/A	\$56.00

619	622	625	626	716
US15	US19	US26	US26D	643e

## SCHLAGE RESIDENTIAL LOCKS

### Residential J Series

#### J - Lock



Dover (DOV)



Marin (MAR)



Solstice (SOL)



Solstice (SOL)  
Collins Rose



Broadway (BRW)



Broadway (BRW)  
Collins Rose

Function	Description	Lever style	Finish	Latch	Strike	Cylinder	Price (ea.)
J40	Privacy	BRW	625	16-254	10-101	N/A	\$63.00
J170	Dummy	BRW	625	N/A	N/A	N/A	\$31.00
J10	Passage	BRW	626	16-254	10-101	N/A	\$56.00
J40	Privacy	BRW	626	16-254	10-101	N/A	\$63.00
J170	Dummy	BRW	626	N/A	N/A	N/A	\$31.00
J10	Passage	BRW	716	16-254	10-101	N/A	\$56.00
J40	Privacy	BRW	716	16-254	10-101	N/A	\$63.00
J170	Dummy	BRW	716	N/A	N/A	N/A	\$31.00
J10	Passage	BRW/COL	619	16-254	10-101	N/A	\$68.00
J40	Privacy	BRW/COL	619	16-254	10-101	N/A	\$71.00
J170	Dummy	BRW/COL	619	N/A	N/A	N/A	\$36.00
J10	Passage	BRW/COL	622	16-254	10-101	N/A	\$68.00
J40	Privacy	BRW/COL	622	16-254	10-101	N/A	\$71.00
J170	Dummy	BRW/COL	622	N/A	N/A	N/A	\$36.00
J10	Passage	BRW/COL	625	16-254	10-101	N/A	\$68.00
J40	Privacy	BRW/COL	625	16-254	10-101	N/A	\$71.00
J170	Dummy	BRW/COL	625	N/A	N/A	N/A	\$36.00
J10	Passage	BRW/COL	626	16-254	10-101	N/A	\$68.00
J40	Privacy	BRW/COL	626	16-254	10-101	N/A	\$71.00
J170	Dummy	BRW/COL	626	N/A	N/A	N/A	\$36.00
J10	Passage	BRW/COL	716	16-254	10-101	N/A	\$68.00
J40	Privacy	BRW/COL	716	16-254	10-101	N/A	\$71.00
J170	Dummy	BRW/COL	716	N/A	N/A	N/A	\$36.00
J10	Passage	MAR	619	16-254	10-101	N/A	\$52.00
J40	Privacy	MAR	619	16-254	10-101	N/A	\$58.00
J170	Dummy	MAR	619	N/A	N/A	N/A	\$29.00
J10	Passage	MAR	622	16-254	10-101	N/A	\$52.00
J40	Privacy	MAR	622	16-254	10-101	N/A	\$58.00
J170	Dummy	MAR	622	N/A	N/A	N/A	\$29.00
J10	Passage	MAR	625	16-254	10-101	N/A	\$52.00
J40	Privacy	MAR	625	16-254	10-101	N/A	\$58.00
J170	Dummy	MAR	625	N/A	N/A	N/A	\$29.00
J10	Passage	MAR	626	16-254	10-101	N/A	\$52.00
J40	Privacy	MAR	626	16-254	10-101	N/A	\$58.00
J170	Dummy	MAR	626	N/A	N/A	N/A	\$29.00
J10	Passage	MAR	716	16-254	10-101	N/A	\$52.00
J40	Privacy	MAR	716	16-254	10-101	N/A	\$58.00



619	622	625	626	716
US15	US19	US26	US26D	643e

SCHLAGE RESIDENTIAL LOCKS

Residential J Series

J - Lock



Dover (DOV)



Marin (MAR)



Solstice (SOL)



Solstice (SOL)  
Collins Rose



Broadway (BRW)



Broadway (BRW)  
Collins Rose

Function	Description	Lever style	Finish	Latch	Strike	Cylinder	Price (ea.)
J170	Dummy	MAR	716	N/A	N/A	N/A	\$29.00
J10	Passage	DOV	619	16-254	10-101	N/A	\$52.00
J40	Privacy	DOV	619	16-254	10-101	N/A	\$58.00
J170	Dummy	DOV	619	N/A	N/A	N/A	\$29.00
J10	Passage	DOV	622	16-254	10-101	N/A	\$52.00
J40	Privacy	DOV	622	16-254	10-101	N/A	\$58.00
J170	Dummy	DOV	622	N/A	N/A	N/A	\$29.00
J10	Passage	DOV	625	16-254	10-101	N/A	\$52.00
J40	Privacy	DOV	625	16-254	10-101	N/A	\$58.00
J170	Dummy	DOV	625	N/A	N/A	N/A	\$29.00
J10	Passage	DOV	626	16-254	10-101	N/A	\$52.00
J40	Privacy	DOV	626	16-254	10-101	N/A	\$58.00
J170	Dummy	DOV	626	N/A	N/A	N/A	\$29.00
J10	Passage	DOV	716	16-254	10-101	N/A	\$52.00
J40	Privacy	DOV	716	16-254	10-101	N/A	\$58.00
J170	Dummy	DOV	716	N/A	N/A	N/A	\$29.00
J40P	Privacy	SEV	619	16-254	10-101	N/A	\$60.00
J40P	Privacy	SEV	625	16-254	10-101	N/A	\$60.00
J40P	Privacy	SEV	716	16-254	10-101	N/A	\$60.00
J40P	Privacy	SOL	619	16-254	10-101	N/A	\$65.00
J40P	Privacy	SOL	625	16-254	10-101	N/A	\$65.00
J40P	Privacy	SOL	716	16-254	10-101	N/A	\$65.00
J40P	Privacy	TOR	619	16-254	10-101	N/A	\$60.00
J40P	Privacy	TOR	716	16-254	10-101	N/A	\$60.00
J40P	Privacy	TOR	625	16-254	10-101	N/A	\$60.00

RESIDENTIAL ELECTRONIC

RESIDENTIAL MECHANICAL

COMMERCIAL WIRELESS ELECTRONIC

COMMERCIAL MECHANICAL/ELECTRIFIED





505	605	608	609	613	618	619	620	621	622	626	716
-	US3	-	US5	US10B	-	US15	US15A	-	US19	US26D	643e

## SCHLAGE RESIDENTIAL DEADBOLTS

PRODUCT IDENTIFICATION			
B	60	N	F
Lock Series	Function	N - 5-pin cylinder N6 - 6-pin cylinder R6 - 6-pin cylinder with FSIC	F - UL Listed, available with B60, B80, B61 and B60R6 J - Less full sized construction T - Full sized construction core (FSIC)

PRODUCT IDENTIFICATION		
JD	60	F
Lock Series	Function	F - UL Listed, available with JD81

Specifications			
<b>Grade 1 Deadbolts</b>			
Models	B60, B62, B80, B81	Backset	Adjustable for 2-3/8" or 2-3/4"
Certification	ANSI/BHMA A156.36, 2010, Grade 1	Cylinder	5-pin, keyed 5-pin, C keyway, keyed alike (KA)
Deadbolt	1" x 2-1/4", radius corner, 1" housing diameter, 1" throw, latch number 12-321	Door range	1-3/8"–1-3/4"
Strike	1-1/8" x 2-3/4", 1/4" radius corner, strike number 10-116	Keys	Two cut keys per lock, 5-pin, C section
		Reinforcement	Door frame strike reinforcer with 3" screws
<b>Grade 2 Deadbolts</b>			
Models	B60, B62, B80, B81	Cylinder core	Grade 2, 6-pin keyed 6-pin, C keyway, keyed different (KD)
Certification	ANSI/BHMA A156.36, 2010, Grade 2	Door range	1-3/8"–1-3/4"
Deadbolt	1" x 2-1/4", radius corner, 1" housing diameter, 1" throw, latch number 12-321	Keys	Two user keys, 6-pin, C section, control key ordered separately
Strike	1-1/8" x 2-3/4", 1/4" radius corner, strike number 10-116	Reinforcement	Door frame strike reinforcer with 3" screws
Backset	Adjustable for 2-3/8" or 2-3/4"		
Note: Locks are furnished with standard features unless otherwise specified. To order locks with non-standard features, please specify non-standard feature desired.			

### Finish codes and descriptions<sup>1</sup>

	505	605	608	609	613	618	619	620	621	622	626	716
Lifetime Bright Brass	Bright Brass (US3) <sup>2</sup>	Satin Brass	Antique Brass (US5)	Oil Rubbed Bronze (US10B)	Polished Nickel (US14)	Satin Nickel (US15) <sup>2</sup>	Antique Pewter (US15A)	Distressed Nickel (US17A)	Matte Black (US19)	Satin Chrome (US26D) <sup>2</sup>	Aged Bronze (643e) <sup>2</sup>	

1. Non-Standard finishes are not available.
2. B60R available finishes.



505	605	608	609	613	618	619	620	621	622	626	716
-	US3	-	US5	US10B	-	US15	US15A	-	US19	US26D	643e

## SCHLAGE RESIDENTIAL B SERIES DEADBOLT

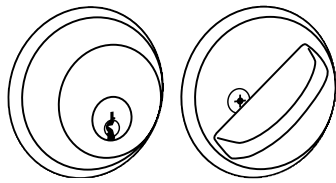

B60

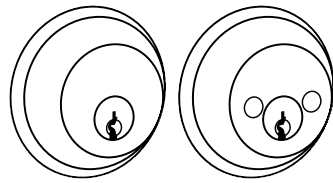

B62

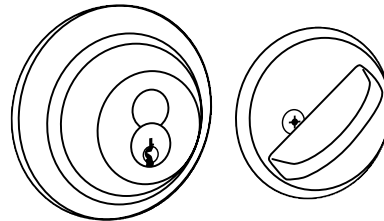

B60R6



### Standard features

- BHMA Grade 1 product performance (B60, B62, B80, B81)
- BHMA Grade 2 product performance (B60R6)
- Increased latch/bolt size offers maximum kick-in resistance
- Exclusive patented Schlage design
- Anti-pick shield
- Full-size Interchangeable Core B60R6
- Schlage Limited Lifetime Mechanical and Finish Warranty
- Finishes that feature ultraviolet (UV) resistance up to 4 times the BHMA standard: Satin Nickel, Bright Brass, Antique Brass, and Antique Pewter
- Contoured edges for added style convenience
- Larger thumb turn for easy grip

### GRADE 1 DEADBOLT STANDARD FEATURES/CONFIGURATIONS

<b>Models</b>	B60, B62, B80, B81
<b>Certification</b>	ANSI/BHMA A156.36, 2010, Grade 1
<b>Deadbolt</b>	1" x 2-1/4", radius corner, 1" housing diameter, 1" throw, latch number 12-321
<b>Strike</b>	1-1/8" x 2-3/4", 1/4" radius corner, strike number 10-116
<b>Backset</b>	Adjustable for 2-3/8" or 2-3/4"
<b>Cylinder</b>	5-pin, keyed 5-pin, C keyway, keyed alike (KA4)
<b>Door range</b>	1-3/8" – 1-3/4"
<b>Keys</b>	Two keys per lock, 5-pin, keyed 5-pin, C section
<b>Reinforcement</b>	Door frame strike reinforcer with 3" screws

\* Locks are furnished with standard features unless otherwise specified. To order locks with non-standard features, specify non-standard feature desired.

### B Series Deadbolts

### FINISHES

Function	Packaging	605	505	530	608	609	618	619	620	621	622	625	626	716
B60 Single cylinder	Box	\$73.00	\$83.00	\$83.00	\$83.00	\$83.00	\$83.00	\$83.00	\$83.00	\$83.00	\$83.00	\$83.00	\$83.00	\$83.00
B62 Double cylinder	Box	\$107.00	\$115.00	▪	\$115.00	\$115.00	\$115.00	\$115.00	\$115.00	\$115.00	\$115.00	\$115.00	\$115.00	\$115.00
B80 One-sided	Box	\$49.00	▪	▪	\$58.00	\$58.00	\$58.00	\$58.00	\$58.00	\$58.00	\$58.00	\$58.00	\$58.00	\$58.00
B81 One-sided with trim	Box	\$52.00	\$62.00	▪	\$62.00	\$62.00	\$62.00	\$62.00	\$62.00	\$62.00	\$62.00	\$62.00	\$62.00	\$62.00
B60R6 Single cylinder interchangeable core, 6-pin	Box	▪	\$213.00	▪	▪	▪	▪	\$211.00	▪	▪	▪	▪	\$211.00	\$213.00

### List price adders:

UL Latch - add \$7.00 to list price (B60, B80, B81 and B60R6)

RESIDENTIAL ELECTRONIC  
RESIDENTIAL MECHANICAL  
COMMERCIAL WIRELESS ELECTRONIC  
COMMERCIAL MECHANICAL/ELECTRIFIED

505	605	608	609	613	618	619	620	621	622	626	716
-	US3	-	US5	US10B	-	US15	US15A	-	US19	US26D	643e

## SCHLAGE RESIDENTIAL J SERIES DEADBOLT

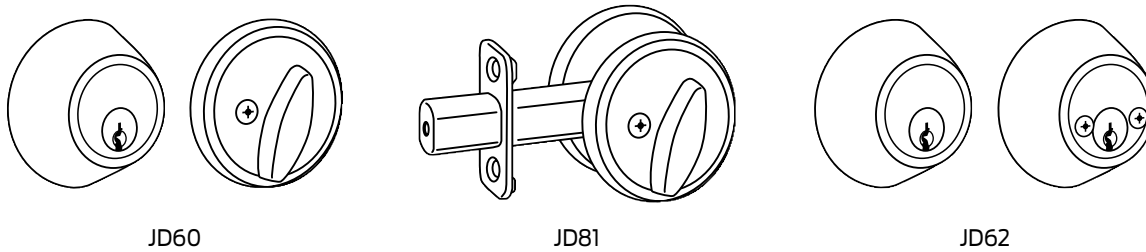

### Standard features

- Strongest locks in the opening price point category
- Largest knobs and levers in its class
- Fits standard door preps
- Easy to install
- Available with Schlage C keyway standard
- Dual or triple option latches available
- Available UL options (JD81)
- Dexter designs suite with many popular designs from Schlage

### GRADE 3 DEADBOLTS STANDARD FEATURES

<b>Models</b>	JD60, JD62, JD81
<b>Certification</b>	ANSI/BHMA A156.36, 2010, Grade 3
<b>Deadbolt latch</b>	Triple Option: 1" x 2-1/4", square corner and 1/4" round faceplates, drive-in latch, 1" housing diameter, 1" throw
<b>Strike</b>	1" x 2-1/4" round corner
<b>Backset</b>	Adjustable for 2-3/8" or 2-3/4"
<b>Cylinder</b>	5-pin, C keyway, keyed alike (KA4)
<b>Door range</b>	1-3/8" – 1-3/4"
<b>Keys</b>	Two keys per lock, 5-pin, keyed 5-pin, C section

### J Series Deadbolts

### FINISHES

Function	Packaging	605	609	619	620	622	625	626	630	716
JD60 Single cylinder deadbolt	Box	\$46.00	\$46.00	\$46.00	\$46.00	\$46.00	\$46.00	\$46.00	\$46.00	\$46.00
JD80 One-sided cylinder deadbolt	Box	\$41.00	\$41.00	\$41.00	▪	▪	▪	▪	\$41.00	\$41.00
JD81 One-sided deadbolt with trim	Box	\$41.00	\$41.00	\$41.00	▪	▪	▪	▪	\$41.00	▪
JD60F Single cylinder (UL version)	Box	\$53.00	\$53.00	\$53.00	\$53.00	\$53.00	\$53.00	\$53.00	\$53.00	\$53.00
JD60 Single cylinder deadbolt	Vis	\$51.00	\$51.00	\$51.00	▪	\$51.00	▪	▪	\$51.00	\$51.00
JD62 Double cylinder deadbolt	Vis	\$63.00	\$63.00	\$63.00	▪	▪	▪	▪	\$63.00	\$63.00

**CONSTRUCTION**

## FULL SIZE CONSTRUCTION CORE PROGRAM

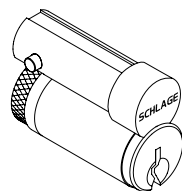

23-030-ICX

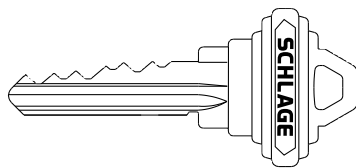

48-101-ICX

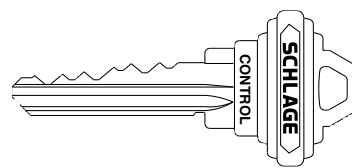

48-056-ICX

**FULL SIZE CONSTRUCTION CORE PROGRAM**

Temporary construction cores may be ordered with full size interchangeable core locks, mortise cylinders and rim cylinders. These cores may also be ordered separately. All construction cores are assessed a non-refundable handling charge (50-231). See Terms and Conditions for more information.

**Features:**

- 5-pin or 6-pin C keyway.
  - Construction cores have a two-tone face: the faceplate is painted orange and the plug is unfinished brass.
  - Back of each core is marked with the letter that identifies the keyed alike group: A, B or C.
  - Construction cores are furnished with no keys (NCK). **Cut keys must be ordered separately.**
  - A control key is required to install and remove construction cores. **Control keys must be ordered separately.**
- If a control key is not ordered, one will be supplied at a list price as shown in the table below.**
- Construction cores may be returned for credit. Contact your Schlage representative for return authorization. Credit is issued upon receipt of cores at our factory.

**FULL-SIZE CONSTRUCTION CORE PROGRAM**

Part number	Description	Specify	Price (ea.)
23-030-ICX	Construction core	New jobs: Specify "ICX" Existing jobs: Specify "ICA", "ICB" or "ICC".	\$121.20
48-101-ICX	Cut key for construction phase (order separately)		\$9.80
48-056-ICX	Cut control key (order separately)		\$19.10
50-231	Non-refundable handling charge (per core)		\$15.20
Notes:	To order mortise and rim cylinders with full size construction cores for a new job, suffix ICX to non-Primus cylinder number. Example: 30-008 ICX. For existing construction core combinations, specify ICA, ICB, or ICC. Construction cores for a given project are keyed alike to one of a limited number of combinations nationwide. Other Schlage projects in the same area using the same or different contractors may use the same key.		

**EXAMPLE:**

Example for construction core charges and credits. distributor XYZ ordered 150 construction cores with 20 keys and one control key. The following charges apply to this order:

1. 23-030-ICX construction cores (150 units).
2. 48-101-ICX cut keys (20 units).
3. 48-056-ICX cut control key (1 unit).
4. 50-231 Non-refundable handling charge (150 units-one per core ordered).

Upon return of the cores to the factory the distributor will be credited for the following:

1. 23-030-ICX construction cores (150 units).

There is no credit for the keys or handling fee.

**STAMPING**

## CYLINDER AND KEY STAMPING

KEY STAMPING (VKC)			
Part number	Description	Specify	Price (ea.)
50-217	Visual key control that allows for visual matching of user and control keys to appropriate cylinders	Stamp key symbol on key	No charge

CYLINDER STAMPING (CKC)			
Part number	Description	Specify	Price (ea.)
50-216	Visual cylinder control that allows for visual matching of cylinders to appropriate user and control keys. Must specify VKC for face marking of CKC for side of cylinder marking per cylinder. When ordering keys/cylinders marked for ID purposes (VKC and CKC) both PN 50-216 and 50-217 must be ordered as separate items.	Stamp key symbol or non-conventional code on side (CKC) of core	\$10.00 per cylinder

**CHARGES**

## KEYING CHARGES

BITTING LIST		
Part number	Description	Price (ea.)
50-123	Bitting List for factory master keyed products (requires written authorization from end-user)	\$348.40

LE MORTISE MOBILE ENABLED WIRELESS LOCK ■ OVERVIEW

**Standard features**



Certification	ANSI/BHMA Certified A156.25-2013 (Indoor/Outdoor), ANSI/BHMA Certified A156.13-2012, Series 1000, Grade 1 UL 294, ULC S319, UL 10C 3-hour rated
Case size	4-7/16" x 6-1/16" x 1"
Armor front	1-1/4" x 8"
Deadbolt	1" throw stainless steel
Latch bolt	3/4" throw stainless steel with anti-friction tongue
Strike	1-1/4" x 4-7/8", square corner, 1-3/16" lip with box and DPS
Backset	2-3/4"
Cylinder	6-pin solid brass, keyed 6-pin, S123 keyway, keyed different (KD)
Door range	1-3/4" door thickness standard (can be ordered to accommodate doors 1-3/4" to 2-1/4" thick)
Keys	Two nickel silver cut keys per lock, 6-pin, S123 section

**Finish codes and descriptions**

BHMA code	Description
605 (US 3)	Bright Brass
606 (US 4)	Satin Brass
612 (US 10)	Satin Bronze
619 (US 15)	Satin Nickel
622 (US 19)	Matte Black
625 (US 26)	Bright Chromium Plated
626 (US 26D)	Satin Chrome
626AM	Satin Stainless Steel, Antimicrobial
643e (US 11)	Aged Bronze



06 (Rhodes)



07 (Athens)



17 (Sparta)



LAT (Latitude)



LON (Longitude)



M52 (Broadway)



M81 (Boardwalk)

**CONTACT INFORMATION FOR LE LOCKS AND DEVICES**

Payment Address: Schlage Electronic Security  
15934 Collections Center Drive  
Chicago, IL 60693

**Customer service**

- Order status
- Credit returns of non-defective products
- General sales questions

Email orders to:  
Allegion\_Orders@allegion.com

**Technical support**

- Technical questions/issues
- Returns of defective products
- Repairs

Contact for technical assistance:  
Electronic\_Lock\_TechProdSupport@allegion.com

RESIDENTIAL ELECTRONIC  
RESIDENTIAL MECHANICAL  
COMMERCIAL WIRELESS ELECTRONIC  
COMMERCIAL MECHANICAL/ELECTRIFIED

**FUNCTIONS**

**ADDISON ESCUTCHEON SHOWN**

LEBMS and LEBSIMS - Mortise with LED Indicator		
<b>Storeroom/ Classroom</b>	<p>Lockset is normally secure. Valid normal credential or key momentarily unlocks door. Valid toggle credential may be used to change to a passage or secured state. A mechanical key will retract the latch. An inside indicator LED confirms state of the lock. Inside lever always allows free egress.</p>	
LEBMB and LEBSIMB - Mortise with Interior Push Button and LED		
<b>Office</b>	<p>Lockset is normally secure. Valid normal credential or key momentarily unlocks door. Valid toggle credential may be used to change to a passage or secured state. Interior push button on inside housing can be used to select a passage or secured state and confirms state of the lock via LED indicator. A mechanical key will retract the latch. Inside lever always allows free egress. Meets the need for lockdown function for safety and security.</p>	
<b>Privacy</b>	<p>Lockset is normally secure. Valid normal credential or key momentarily unlocks door. Valid toggle credential may be used to change to a passage or secured state. Interior pushbutton on inside housing may be used to select a privacy status. The interior pushbutton will disable normal electronic access from the exterior and confirms state of the lock via LED indicator. Opening the door or pressing the interior pushbutton a second time on the inside housing deactivates the privacy status. A mechanical key will always retract the latch. Inside lever always allows free egress. Door position sensor required for function.</p>	
<b>Apartment</b>	<p>Lockset is normally secure. Valid normal or toggle credential is used to change to a passage or secured state. Interior pushbutton on inside housing may be used to select a passage or secured state and confirms state of the lock via LED indicator. Opening the door or pressing the interior pushbutton a second time causes the lockset to toggle to passage. While in passage mode, the lockset can only be secured while the door is closed by pressing the interior pushbutton or using a normal credential on the exterior. A mechanical key will retract the latch. Inside lever always allows free egress. Door position sensor required for function.</p>	
LEBMD and LEBSIMD - Mortise Deadbolt with LED		
<b>Privacy</b>	<p>Lockset is normally secure. Valid normal credential or key momentarily unlocks door. Valid toggle credential may be used to change to a passage or secured state. Thumbturn on inside housing may be used to select a privacy status. The thumbturn will disable normal electronic access from the exterior and confirms state of the lock via LED indicator. Opening the door or retracting the deadbolt deactivates the privacy status. A mechanical key will always retract the latch. Inside lever always allows free egress. Door position sensor required for function.</p>	
<b>Apartment</b>	<p>Lockset is normally secure. Valid normal or toggle credential is used to change to a passage or secured state. Thumbturn on inside housing may be used to select a passage or secured state and confirms state of the lock via LED indicator. Opening the door or retracting the deadbolt causes the lockset to toggle to passage. While in passage mode, the lockset can only be secured while the door is closed by rotating thumbturn or using a normal credential on the exterior. A mechanical key will retract the latch. Inside lever always allows free egress. Door position sensor required for function.</p>	

Handing		
<b>RH</b>	Right handed: Hinges on right opens inward	
<b>LH</b>	Left handed: Hinges on left opens inward	
<b>RHR</b>	Right handed reverse: Hinges on right opens outward	
<b>LHR</b>	Left handed reverse: Hinges on left opens outward	

## STANDARD LEVER COLLECTION

<p><b>01</b></p>	<p><b>02</b></p>	<p><b>03 (TUBULAR)</b></p>	<p><b>05</b></p>
<p><b>06 (RHODES)</b></p>	<p><b>07 (ATHENS)</b></p>	<p><b>12</b> </p> <p>Handing required</p>	<p><b>17 (SPARTA)</b></p>
<p><b>18</b></p>	<p><b>LATITUDE (LAT)</b></p>	<p><b>LONGITUDE (LON)</b></p>	<p><b>OMEGA (OME)</b></p>
<p><b>ACCENT (ACC)</b> </p> <p>Handing required</p>	<p><b>ASTI (AST)</b> </p> <p>Handing required</p>	<p><b>MERANO (MER)</b> </p> <p>Handing required</p>	
<p><b>41</b></p>	<p><b>42</b></p>		

 RESIDENTIAL ELECTRONIC  
 RESIDENTIAL MECHANICAL  
 COMMERCIAL WIRELESS ELECTRONIC  
 COMMERCIAL MECHANICAL/ELECTRIFIED



**M LEVER COLLECTION**

<p><b>M51</b></p> <p>3.2" 4.5" 2.4"</p>	<p><b>M52</b></p> <p>3" 4.5" 2.2"</p>	<p><b>M53</b></p> <p>3.2" 4.35" 2.6"</p>	<p><b>M54</b></p> <p>2.75" 4.35" 2.3" 2.14"</p>
<p><b>M55</b></p> <p>3" 4.3" 2.14"</p>	<p><b>M56</b></p> <p>3" 4.6" 2.4" 2.1"</p>	<p><b>M61</b>  Handing required</p> <p>3.2" 4.5" 2.1"</p>	<p><b>M63</b>  Handing required</p> <p>3.2" 4.5" 2.1"</p>
<p><b>M81</b></p> <p>2.9" 4.8" 2.1" 0.4"</p>	<p><b>M82</b></p> <p>2.9" 4.8" 2.2" 0.4"</p>	<p><b>M83</b></p> <p>2.9" 4.6" 2.1" 0.4"</p>	<p><b>M84</b></p> <p>3" 5.1" 2.1" 0.4"</p>
<p><b>M85</b>  Handing required</p> <p>3.3" 4.9" 2.1" 0.3"</p>	<p><b>ME1</b></p> <p>3.0" 5.5" 2.125" 0.4"</p>	<p><b>ME2</b></p> <p>2.8" 5.2" 2.125" 0.4"</p>	<p><b>ME3</b></p> <p>3.2" 5.1" 2.125" 0.4"</p>

**WROUGHT ROSE DESIGNS**

**00A**

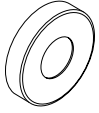

2 1/8" (54 mm) diameter

**00B**

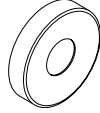

2 1/16" (65mm) diameter

**00C**

Not available in 612 finish



2 5/8" (66mm) diameter

**AVA**

ACC lever only



2 5/8" (66mm) diameter

**MER**

MER lever only



2 5/8" (66mm) diameter

**WROUGHT ESCUTCHEON DESIGN**

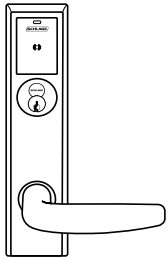

07 Lever shown

**TACTILE OPTIONS**

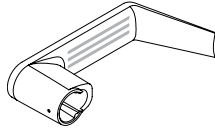

06 Lever shown  
(See LE ordering pages for availability)

COMMERCIAL LEVER SUITING						
Standard Levers						
L /LE Mortise	LT Tubular	ND /NDE Cylindrical	AD/CO Series	AL Cylindrical	S Tubular	33A/35A, 94/95, 98/99 Exit devices (Von Duprin)
01	01	-	-	-	-	01
02	02	-	-	-	-	02
03	03	Tubular <sup>1</sup>	Tubular	-	-	03
05	05	-	-	-	-	05
06	06	Rhodes	Rhodes	Saturn	Saturn	06
07	07	Athens	Athens	Jupiter	Jupiter	07
12	12	-	-	-	-	12
17	17	Sparta	Sparta	Neptune	Neptune	17
18	18	-	-	-	-	18
Latitude	Latitude	Latitude	-	-	-	Latitude
Longitude	Longitude	Longitude	-	-	-	Longitude
Omega <sup>1</sup>	Omega	Omega <sup>1</sup>	-	Omega	-	16
Asti	Asti	-	-	-	Flair	Asti
Merano	Merano	-	-	-	-	Merano
Accent	Accent	-	-	-	-	Accent
M52 <sup>1</sup>	M52 <sup>1</sup>	Broadway	-	-	-	-
M81 <sup>1</sup>	M81 <sup>1</sup>	Boardwalk	-	-	-	-
M Collection Levers						
L /LE Mortise	LT Tubular	ND /NDE Cylindrical	AD/CO Series	AL Cylindrical	S Tubular	33A/35A, 94/95, 98/99 Exit devices (Von Duprin)
M51	M51	-	-	-	-	M51
M52	M52	-	-	-	-	M52
M53	M53	-	-	-	-	M53
M54	M54	-	-	-	-	M54
M55	M55	-	-	-	-	M55
M56	M56	-	-	-	-	M56
M57 <sup>2</sup>	M57	-	-	-	-	M57
M61	M61	-	-	-	-	M61
M62 <sup>2</sup>	M62	-	-	-	-	M62
M63	M63	-	-	-	-	M63
M81	M81	-	-	-	-	M81
M82	M82	-	-	-	-	M82
M83	M83	-	-	-	-	M83
M84	M84	-	-	-	-	M84
M85	M85	-	-	-	-	M85
ME1	ME1	-	-	-	-	ME1
ME2	ME2	-	-	-	-	ME2
ME3	ME3	-	-	-	-	ME3

1. Not available on NDE Series locks. M52 is equivalent to the Broadway lever and M81 to the Boardwalk lever.

2. Not available on LE Series locks.

**COMPLETE LOCKS** CYLINDERS

Keyed locks are priced including the P6 cylinder with open keyway. Provided below are pricing adjustments based on other available cylinder types. For Primus and Primus XP cylinders, order lock less cylinder and order the Primus or Primus XP cylinder separately.

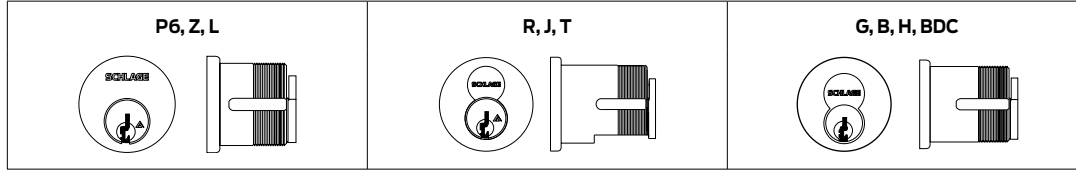

CYLINDER	
<b>P6</b>	With mortise cylinder, Schlage Everest 29 S123 6-pin Keyed different as standard with two keys For master keying, additional charge applies Specify line item 50-210 per master-keyed lock
<b>Z</b>	With mortise cylinder, Schlage Everest SL 7-pin - factory master keyed only
<b>L</b>	Less mortise cylinder
<b>R</b>	With cylinder, Schlage Everest 29 S123 6-pin Full Size Interchangeable Core (FSIC) Keyway one bitted as standard with two keys
<b>J</b>	Less cylinder, Schlage 6-pin FSIC
<b>T</b>	T Construction core Full Size Interchangeable Core (FSIC)
<b>G</b>	With cylinder, Schlage Everest 29 R 7-pin Small Format Interchangeable Core (SFIC) Factory master keyed with two keys as standard, master keying must be specified
<b>B</b>	Less cylinder Schlage, Falcon, Competitive OEM's 7-pin SFIC
<b>H</b>	Construction core SFIC A non-refundable handling charge applies
<b>BDC</b>	Disposable core SFIC

1. For P, R, Z and GD, master keyed cylinders can be specified and will be shipped in lock packaging.
2. For Master Key System Summary form which should accompany the master keyed order, see Electronic Security price book.
3. Control Keys for installation/removal of interchangeable cores are not furnished and must be ordered separate.
4. For additional assistance on Master Keying as well as restricted keyways please contact your local sales representative.

CYLINDER AND LENGTH REQUIREMENTS				
Cylinder type	Cylinder	Door thickness (+/- 1/8")		
		1-3/4"	2"	2-1/4"
Mortise cylinder	30-021 <sup>3</sup>	1-1/4" (114), 1-3/8" (138), 1-1/2" (112)	1-3/8" (138), 1-1/2" (112), 1-5/8" (158)	1-1/2" (112), 1-5/8" (158), 1-3/4" (134)
FSIC	30-016 <sup>4</sup>	1-1/2" (112)		
SFIC	80-108 <sup>4</sup>	1-3/8" (138)		N/A

1. 112 Standard length will ship with lock.
2. Product is Less Core.
3. Cylinders include compression spring.
4. Assumes EE (equally extended).
5. Door thickness range supported: minimum 1-5/8" to maximum 2-3/8".
6. Supports all functions (MS, MB, MD) for both ADD and GRW.

605	606	612	619	622	625	626	643E	626AM
US3	US4	US10	US15	US19	US26	US26D	US11	-

**GREENWICH**

LE MORTISE MOBILE ENABLED WIRELESS LOCK



**1-3. Select chassis/function/style**

**Price**

Check with access control software partner or PACS provider to verify function and/or mobile enabled version is supported by software.		
LEBMS-GRW	Mobile enabled mortise with LED indicator: Storeroom function	\$1,834.00
LEBMB-GRW	Mobile enabled mortise with push button and LED: Privacy, Office, Apartment functions	\$1,880.00
LEBMD-GRW	Mobile enabled mortise deadbolt with LED: Privacy, Apartment functions	\$1,982.00
LEBSIMS-GRW	Mobile enabled mortise with HID Credential Secure Sector Compatibility with LED indicator: Storeroom function	\$1,967.00
LEBSIMB-GRW	Mobile enabled mortise with HID Credential Secure Sector Compatibility with push button and LED: Privacy, Office, Apartment functions	\$2,013.00
LEBSIMD-GRW	Mobile enabled mortise deadbolt with HID Credential Secure Sector Compatibility with LED: Privacy, Apartment functions	\$2,115.00

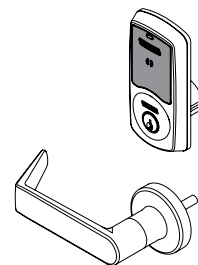

Outside

**4. Select cylinder type**

**Price adjustment**  
Open      Restricted

△ ● P6	Mortise cylinder, Schlage® 6-pin (Everest 29 S123 standard)	No charge	\$31.00
● Z	Mortise cylinder, Schlage Everest SL, 7-pin (factory master keyed only)	N/A	\$31.00
L	Less mortise cylinder	\$31.00	\$31.00
□ ● R	FSIC with cylinder, Schlage 6-pin (Everest 29 S123 standard)	No Charge	\$31.00
J	Less FSIC, Schlage, 6-pin	No charge	No charge
T	FSIC construction core	\$106.00	N/A
□ ● G	SFIC with cylinder, Schlage 7-pin (Everest 29R standard) (factory master keyed only)	N/A	\$144.00
B	Less SFIC, Schlage, Falcon®, competitive OEM's, 7-pin	-\$15.00	-\$15.00
H	SFIC construction core	\$64.00	N/A
BDC	SFIC disposable	-\$15.00	N/A
50-231	Construction core handling charge (non-refundable)	\$15.20	\$15.20

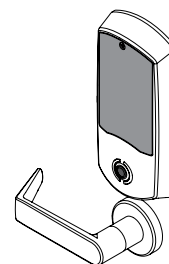

MS with LED

● Master keyed cylinders will be shipped in lock package. To specify, send Master Keying System Summary form (see SES price book) with order or go to [kss.allegion.com](http://kss.allegion.com).

△ For master keying, an additional charge of \$29.40 each applies. Specify line item 50-210.

□ Control keys for installation/removal of interchangeable cores are not furnished and must be ordered separate.

Note: Maximum door thickness with SFIC Cylinder is 2", otherwise compatible with 1-3/4" to 2-1/4" doors.

For additional assistance on Master Keying as well as restricted keyways, please contact customer service.

**5. Select outside lever**

**Price adjustment**

03	Suites with Tubular style	No charge
06	Suites with Rhodes style	No charge
07	Suites with Athens style	No charge
17	Suites with Sparta style	No charge
LAT	Latitude	No charge
Standard options	01, 02, 05, 12, 18, LON, OME, ACC, AST, MER, 41, 42 (also 03, 06, 07, 17, and LAT)	No charge
M Collection options	M51, M52, M53, M54, M55, M56, M61 <sup>1</sup> , M63, M81, M82, M83, M84, M85, ME1, ME2, ME3	\$30.00
8xx <sup>2</sup>	Tactile Warning on standard levers available for 01, 02, 03, 05, 06, 07, 12, 17, and 18	\$74.00
8xx <sup>2</sup>	Tactile Warning on M collection levers available for M51, M52, and M81	\$104.00

1. M61 is not offered in 612 finish.

2. Ordering instructions: Preface lever design code with 8. Example: 803 for 03, 851 for M51, etc.

Applied to exterior lever only unless otherwise specified. Not available with 643e finish.

Reference pages 32 and 33 to see style option images.

**6. Select outside finish**

**Price adjustment**

626	Satin Chrome	No charge
605	Bright Brass	\$89.00
606	Satin Brass	\$89.00
612 <sup>3</sup>	Satin Bronze	\$89.00
619	Satin Nickel	\$89.00
622	Matte Black	\$89.00
625	Bright Chrome	\$89.00
643e	Aged Bronze	\$89.00
626AM	Satin Chrome Antimicrobial	\$128.00

3. 00C rose not available in 612 finish.

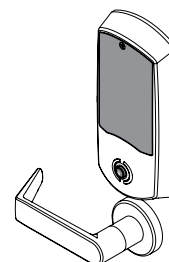

MB with interior push button and LED

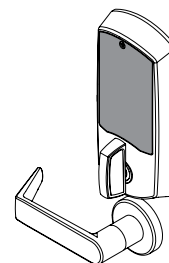

MD Deadbolt with LED



605	606	612	619	622	625	626	643E	626AM
US3	US4	US10	US15	US19	US26	US26D	US11	-

## GREENWICH

## LE MORTISE MOBILE ENABLED WIRELESS LOCK

7. Select outside rose		Price adjustment
00A	2-1/8" (54 mm) diameter	Standard
00B	2-9/16" (65 mm) diameter	No charge
00C	2-5/8" (66 mm) diameter with bevel (Not available in 612 finish)	No charge
AVA	Decorative rose 2-5/8" (66 mm) diameter, supports ACC lever only	No charge
MER	Decorative rose 2-5/8" (66 mm) diameter, supports MER lever only	No charge
8. Select inside lever (Note: Specify only if different from Outside Lever.)		Price adjustment
Standard options	01, 02, 03, 05, 06, 07, 12, 17, 18, LAT, LON, OME, ACC, AST, MER, 41, and 42	No charge
M Collection options <sup>4</sup>	M51, M52, M53, M54, M55, M56, M61, M63, M81, M82, M83, M84, and M85	\$30.00
4. \$30.00 price adder for M Collection levers only applies if outside lever is Standard.		
9. Select inside finish <sup>5</sup> (Note: Specify only if different from Outside Finish.)		Price adjustment
See options in section 6.		\$89.00-\$128.00
5. Upcharge only applies if outside finish is 626 and you are specifying a different inside finish.		
10. Select inside rose (Note: Specify only if different from Outside Rose.)		Price adjustment
See options in section 7.		No charge
11. Select handing (field reversible)		Price adjustment
RH	Right handed	Standard
LH	Left handed	No charge
RHR	Right handed reverse	No charge
LHR	Left handed reverse	No charge
12. Select strike lip length		Price adjustment
10-136	1-3/16" lip length (MS and MB only)	Standard
10-136-112	1-1/2" lip length (MS and MB only)	No charge
10-136-134	1-3/4" lip length (MS and MB only)	\$42.00
10-072	1-3/16" lip length (MD only)	Standard
10-072-112	1-1/2" lip length (MD only)	No charge
10-072-134	1-3/4" lip length (MD only)	\$48.40
13. Select door thickness		Price adjustment
134	1-3/4"	Standard
200	2"	\$78.80
214	2-1/4"	\$78.80
14. Select keying type		Price adjustment
Open keyway families (Mortise cylinder or FSIC) <sup>6</sup>		
S123	Everest 29 S (Key in Lever or FSIC)	Standard
C123	Everest C	No charge
C/CE/E/EF/F/FG/G	Classic Obverse	No charge
Restricted keyway families (Mortise cylinder or FSIC) <sup>6,7</sup>		
29T	Everest 29 T	\$31.00
D	Everest D	\$31.00
Classic Restricted	Quad, Numbered, Reverse	\$31.00
Restricted keyway families (SFIC) <sup>8</sup>		
29R	Everest 29 R	No charge
B	Everest B	No charge

6. Full size key systems (Everest 29 S and T, Everest C and D, Obverse and Quad) are available in Primus and Primus XP key system and must be ordered separately. Lock should be ordered less cylinder and Primus cylinder should be a separate line item.

7. Everest Restricted Keyways require a Letter of Authorization submitted with the order. See sample Letter of Authorization in SES price book.

8. For restricted keyways, please see Terms and Conditions.

605	606	612	619	622	625	626	643E	626AM
US3	US4	US10	US15	US19	US26	US26D	US11	-

**ADDISON**

LE MORTISE MOBILE ENABLED WIRELESS LOCK



**1-3. Select chassis/function/style**

		Price
Check with access control software partner or PACS provider to verify function and/or mobile enabled version is supported by software.		
LEBMS-ADD	Mobile enabled mortise with LED indicator: Storeroom function	\$1,894.00
LEBMB-ADD	Mobile enabled mortise with push button and LED: Privacy, Office, Apartment functions	\$1,940.00
LEBMD-ADD	Mobile enabled mortise deadbolt with LED: Privacy, Apartment functions	\$2,042.00
LEBSIMS-ADD	Mobile enabled mortise with HID Credential Secure Sector Compatibility with LED indicator: Storeroom function	\$2,027.00
LEBSIMB-ADD	Mobile enabled mortise with HID Credential Secure Sector Compatibility with push button and LED: Privacy, Office, Apartment functions	\$2,073.00
LEBSIMD-ADD	Mobile enabled mortise deadbolt with HID Credential Secure Sector Compatibility with LED: Privacy, Apartment functions	\$2,175.00

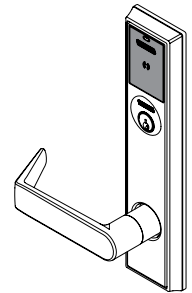

Outside

**4. Select cylinder type**

		Price adjustment	
		Open	Restricted
<input type="checkbox"/> ● P6	Mortise cylinder, Schlage® 6-pin (Everest 29 S123 standard)	No charge	\$31.00
● Z	Mortise cylinder, Schlage 7-pin (Everest SL standard) (factory master keyed only)	N/A	\$31.00
L	Less mortise cylinder	\$31.00	\$31.00
<input type="checkbox"/> ● R	FSIC with cylinder, Schlage 6-pin (Everest 29 S123 standard)	No charge	\$31.00
J	Less FSIC, Schlage, 6-pin FSIC	No charge	No charge
T	FSIC construction core	\$106.00	N/A
<input type="checkbox"/> ● G	SFIC with cylinder, Schlage 7-pin (Everest 29R standard) (factory master keyed only)	N/A	\$144.00
B	Less SFIC, Schlage, Falcon®, competitive OEM's, 7-pin	-\$15.00	-\$15.00
H	SFIC construction core	\$64.00	N/A
BDC	SFIC disposable	-\$15.00	N/A
50-231	Construction core handling charge (non-refundable)	\$15.20	\$15.20

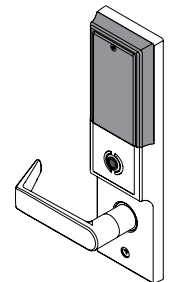

MS with LED

- Master keyed cylinders will be shipped in lock package. To specify, send Master Keying System Summary form (see SES price book) with order or go to [kss.allegion.com](http://kss.allegion.com).
  - △ For master keying, an additional charge of \$29.40 each applies. Specify line item 50-210.
  - Control keys for installation/removal of interchangeable cores are not furnished and must be ordered separate.
- Note: Maximum door thickness with SFIC Cylinder is 2", otherwise compatible with 1-3/4" to 2-1/4" doors.  
For additional assistance on Master Keying as well as restricted keyways, please contact customer service.

**5. Select outside lever**

		Price adjustment
03	Suites with Tubular style	No charge
06	Suites with Rhodes style	No charge
07	Suites with Athens style	No charge
17	Suites with Sparta style	No charge
LAT	Latitude	No charge
Standard options	01, 02, 05, 12, 18, LON, OME, ACC, AST, MER, 41, 42 (also 03, 06, 07, 17, and LAT)	No charge
M Collection options	M51, M52, M53, M54, M55, M56, M61, M63, M81, M82, M83, M84, M85, ME1, ME2, ME3	\$30.00
8xx <sup>1</sup>	Tactile Warning on standard levers available for 01, 02, 03, 05, 06, 07, 12, 17, and 18	\$74.00
8xx <sup>1</sup>	Tactile Warning on M collection levers available for M51, M52, and M81	\$104.00

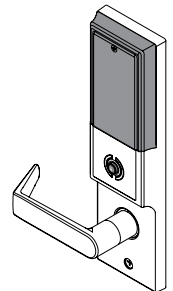

MB with interior push button and LED

1. Ordering instructions: Preface lever design code with 8. Example: 803 for 03, 851 for M51, etc.  
Applied to exterior lever only unless otherwise specified. Not available with 643e finish.  
Reference pages 32 and 33 to see style option images.

**6. Select outside finish**

		Price adjustment
626	Satin Chrome	No charge
605	Bright Brass	\$89.00
606	Satin Brass	\$89.00
612	Satin Bronze	\$89.00
619	Satin Nickel	\$89.00
622	Matte Black	\$89.00
625	Bright Chrome	\$89.00
643e	Aged Bronze	\$89.00
626AM	Satin Chrome Antimicrobial	\$128.00

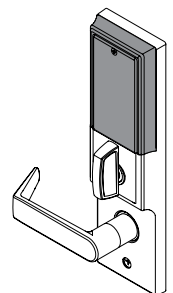

MD Deadbolt with LED



605	606	612	619	622	625	626	643E	626AM
US3	US4	US10	US15	US19	US26	US26D	US11	-

## ADDISON

## LE MORTISE MOBILE ENABLED WIRELESS LOCK

**7. Select outside rose****(Note: Not applicable to Addison)****8. Select inside lever** (Note: Specify only if different from Outside Lever.) **Price adjustment**

Standard options	01, 02, 03, 05, 06, 07, 12, 17, 18, LAT, LON, OME, ACC, AST, MER, 41, 42	No charge
M Collection options <sup>2</sup>	M51, M52, M53, M54, M55, M56, M61, M63, M81, M82, M83, M84, and M85	\$30.00

2. \$30.00 price adder for M Collection levers only applies if outside lever is Standard.

**9. Select inside finish<sup>3</sup>** (Note: Specify only if different from Outside Finish.) **Price adjustment**

See options in section 6.	\$89.00-\$128.00
---------------------------	------------------

3. Upcharge only applies if outside finish is 626 and you are specifying a different inside finish.

**10. Select inside rose****Not applicable to Addison****11. Select handing (field reversible)** **Price adjustment**

RH	Right handed	Standard
LH	Left handed	No charge
RHR	Right handed reverse	No charge
LHR	Left handed reverse	No charge

**12. Select strike lip length** **Price adjustment**

10-136	1-3/16" lip length (MS and MB only)	Standard
10-136-112	1-1/2" lip length (MS and MB only)	No charge
10-136-134	1-3/4" lip length (MS and MB only)	\$42.00
10-072	1-3/16" lip length (MD only)	Standard
10-072-112	1-1/2" lip length (MD only)	No charge
10-072-134	1-3/4" lip length (MD only)	\$48.40

**13. Select door thickness** **Price adjustment**

134	1-3/4"	Standard
200	2"	\$78.80
214	2-1/4"	\$78.80

**14. Select keying type** **Price adjustment**

<b>Open keyway families (Mortise cylinder or FSIC)<sup>4</sup></b>		
S123	Everest 29 S (Key in Lever or FSIC)	Standard
C123	Everest C	No charge
C/CE/E/EF/F/FG/G	Classic Obverse	No charge
<b>Restricted keyway families (Mortise cylinder or FSIC)<sup>4,5</sup></b>		
29T	Everest 29 T	\$31.00
D	Everest D	\$31.00
Classic Restricted	Quad, Numbered, Reverse	\$31.00
<b>Restricted keyway families (SFIC)<sup>6</sup></b>		
29R	Everest 29 R	No charge
B	Everest B	No charge

4. Full size key systems (Everest 29 S and T, Everest C and D, Obverse and Quad) are available in Primus and Primus XP key system and must be ordered separately. Lock should be ordered less cylinder and Primus cylinder should be a separate line item.

5. Everest Restricted Keyways require a Letter of Authorization submitted with the order. See sample Letter of Authorization in SES price book.

6. For restricted keyways, please see Terms and Conditions.





605	606	612	619	622	625	626	643E	626AM
US3	US4	US10	US15	US19	US26	US26D	US11	-

**PARTS AND ACCESSORIES**

LEVER AND KNOB KITS														
⌘ Extended factory lead time		☞ Specify handing		Available finishes										
Style	Lever and knob style			605	606	609	612	613	619	622	625	626	643e	626AM
Standard	01⌘, 02⌘, 03, 05⌘, 06, 07, 12☞, 17, 18, 41⌘, 42⌘, OME⌘			▪	▪	N/A	▪	N/A	▪	▪	▪	▪	▪	▪
	ACC⌘, AST⌘, MER⌘, LAT⌘, LON⌘			▪	▪	N/A	N/A	N/A	▪	▪	▪	▪	▪	▪
Decorative	M51, M52, M53⌘, M54⌘, M55⌘, M56⌘, M61⌘☞, M63⌘☞, M81, M82⌘, M83⌘, M84⌘, and M85⌘☞, ME1, ME2, ME3			▪	▪	N/A	N/A	N/A	▪	▪	▪	▪	▪	▪
Description	Specify				Standard levers/knobs		M Collection levers							
	Part number	Lever/knob style	Finish	Door thickness										
Outside lever/knob, retaining clip, insertion tool	09-401	.[Lever/knob]	.[Finish]	.[ ]	\$194.00		\$209.00							
Inside lever + bushing, mounting plate, screw pack, spanner wrench	09-402	.[Lever/knob]	.[Finish]	.[ ]	\$194.00		\$209.00							

Knobs and levers standard default is for 1-3/4" door. 2" and 2-1/4" door widths also available. Specify door thickness if not 1-3/4".

ROSE KITS (GREENWICH ONLY)														
⌘ Extended factory lead time		☞ Specify handing		Available finishes										
Style	Lever and knob style			605	606	609	612	613	619	622	625	626	643e	626AM
Standard	00A, 00B, 00C			▪	▪	N/A	▪	N/A	▪	▪	▪	▪	▪	▪
Decorative	MER, AVA			▪	▪	N/A	N/A	N/A	▪	▪	▪	▪	▪	▪
Description	Specify				Standard and M Collection									
	Part number	Lever/knob style	Rose	Finish										
Inside rose (includes mounting plate and screws)	09-403	.[Lever/knob]	.[Rose]	.[Finish]	\$110.00									
Outside rose + bushing	09-404	.[Lever/knob]	.[Rose]	.[Finish]	\$110.00									
Blank outside rose (not available MER or AVA)	09-508	.[Lever/knob]	.[Rose]	.[Finish]	\$110.00									

Lever design must be specified for proper bushing.

OUTSIDE GREENWICH LEVER/KNOB AND ROSE SUBASSEMBLIES														
⌘ Extended factory lead time		☞ Specify handing		Available finishes										
Style	Lever and knob style			605	606	609	612	613	619	622	625	626	643e	626AM
Standard	01⌘, 02⌘, 03, 05⌘, 06, 07, 12☞, 17, 18, 41⌘, 42⌘, OME⌘			▪	▪	N/A	▪	N/A	▪	▪	▪	▪	▪	▪
	ACC⌘, AST⌘, MER⌘, LAT⌘, LON⌘			▪	▪	N/A	N/A	N/A	▪	▪	▪	▪	▪	▪
Decorative	M51, M52, M53⌘, M54⌘, M55⌘, M56⌘, M61⌘☞, M63⌘☞, M81, M82⌘, M83⌘, M84⌘, and M85⌘☞, ME1, ME2, ME3			▪	▪	N/A	N/A	N/A	▪	▪	▪	▪	▪	▪
Description	Specify				Standard levers/knobs		M Collection levers							
	Part number	Lever/knob style	Rose	Finish										
Outside lever/knob assembly for 00A, 00B or 00C rose	09-506	.[Lever/knob]	.[Rose]	.[Finish]	\$215.00		\$230.00							
Outside lever assembly for AST with Avanti rose or MER with Merano rose only	09-655	.[Lever/knob]	.[Rose]	.[Finish]	\$215.00		N/A							



605	606	612	619	622	625	626	643E	626AM
US3	US4	US10	US15	US19	US26	US26D	US11	-

**PARTS AND ACCESSORIES**

INSIDE SUBASSEMBLIES		Available finishes												
		605	606	609	612	613	619	622	625	626	629	630	643e	626AM
		▪	▪	N/A	▪	N/A	▪	▪	▪	▪	N/A	N/A	▪	▪
Greenwich inside trim assembly without battery cover														
Description	Contents	Specify		Price each										
		Part number	Finish											
Mobile enabled mortise deadbolt (BMD)	Complete trim minus battery cover, battery holder, and mounting screws	47270612	.[Finish]	\$719.00										
Mobile enabled mortise with push button (BMB)		47270613	.[Finish]	\$413.00										
Mobile enabled mortise with LED (BMS)		47270614	.[Finish]	\$698.00										
Addison inside escutcheon assembly without battery cover														
Description	Contents	Specify		Price each										
		Part number	Finish											
Mobile enabled mortise deadbolt (BMD)	Complete escutcheon minus battery cover, battery holder, and mounting screws	47270616	.[Finish]	\$787.00										
Mobile enabled mortise with push button (BMB)		47270617	.[Finish]	\$780.00										
Mobile enabled mortise with LED (BMS)		47270618	.[Finish]	\$774.00										

BMD, BMB, and BMS subassemblies can be used to upgrade an existing LE lock to a LEB mobile enabled lock. This is the only part number needed.

OUTSIDE SUBASSEMBLIES		Available finishes												
		605	606	609	612	613	619	622	625	626	629	630	643e	626AM
		▪	▪	N/A	▪	N/A	▪	▪	▪	▪	N/A	N/A	▪	▪
Greenwich trim														
Description	Contents	Specify		Price each										
		Part number	Finish											
Greenwich trim <sup>1</sup>	(1) Outside reader (electronics and trim) (1) Grounding spring (1) Harness (1) Cover (1) Back plate (2) Screws	L483-016	.[Finish]	\$602.00										
Addison escutcheon														
Description	Contents	Specify			Standard levers/knobs	M Collection levers								
		Part number	Lever/knob style	Finish										
Addison escutcheon	(1) Outside reader (electronics and escutcheon) 47270612 (1) Harness (1) Lever	L483-017	.[Lever/knob]	.[Finish]	\$929.00	\$944.00								
Addison escutcheon <sup>2</sup>	(1) Outside reader (electronics and escutcheon) 47270612 (1) Harness	L483-051	.[Lever/knob]	.[Finish]	\$713.00	-								

1. Does not support HID Secure Sector compatibility.
2. Lever not included.

BATTERY PARTS		
Description	Specify	Price each
Battery harness	L483-039	\$14.00
Battery holder	N623-006	\$51.00
Greenwich battery cover with screw, washer, and magnet	L483-025	\$51.00
Addison battery cover with screw, washer, and magnet	L483-031	\$55.00



605	606	609	612	619	622	625	626	643E	626AM
US3	US4	US5	US10	US15	US19	US26	US26D	US11	-

**PARTS AND ACCESSORIES**

ARMOR FRONTS	Available finishes										
	605	606	609	612	613	619	622	625	626	643e	626AM
	▪	▪	N/A	▪	N/A	▪	▪	▪	▪	▪	▪
Description	Specify					Price each					
	Part number		Finish								
1-1/4" wide for 1-3/4" and larger door thicknesses (for MS, MB, MD)	09-666		.[Finish]			\$55.10					

STRIKES		Available finishes										
		605	606	609	612	613	619	622	625	626	643e	626AM
		▪	▪	N/A	▪	N/A	▪	▪	▪	▪	▪	▪
Description	Contents	Specify					Price each					
		Part number		Finish								
1-1/4" x 4-7/8" strike, 1-3/16" lip length, std. (MS and MB)	(1) Square corner strike	10-136		.[Finish]			\$57.00					
1-1/4" x 4-7/8" strike, 1-1/2" lip length (MS and MB)	(2) Screws	10-136-112		.[Finish]			\$58.00					
1-1/4" x 4-7/8" strike, 1-3/4" lip length (MS and MB)	(1) Strike box (includes DPS magnet)	10-136-134		.[Finish]			\$98.00					
Strike box with magnet tray only (MS and MB)	-	L583-761		-			\$23.40					
DPS magnet (For L583-761 only)	-	L583-760		-			\$23.40					
1-1/4" x 4-7/8" strike, 1-3/16" lip length, std. (MD only)	(1) Square corner strike	10-072		.[Finish]			\$33.30					
1-1/4" x 4-7/8" strike, 1-1/2" lip length (MD only)	(2) Screws	10-072-112		.[Finish]			\$33.30					
1-1/4" x 4-7/8" strike, 1-3/4" lip length (MD only)	(1) Strike box	10-072-134		.[Finish]			\$85.30					
Strike box only (MD only)	-	K510-066		-			\$10.10					

MORTISE CYLINDERS		Available finishes										
		605	606	609	612	613	619	622	625	626	643e	626AM
		▪	▪	N/A	▪	N/A	▪	▪	▪	▪	▪	▪
Cylinder only		Specify			Price each							
		Part number	Finish	Cyl. Length	Open	Restricted						
Conventional (non-Everest, non-Primus) - 1-1/2" length		30-021-112	.[Finish]	.112	\$111.00	\$142.00						
Primus controlled access - 1-1/2" length		20-793-112	.[Finish]	.112	\$247.00							
Primus XP controlled access - 1-1/2" length		20-793-112-XP	.[Finish]	.112	\$247.00							
Primus UL 437 - 1-1/2" length		20-593-112	.[Finish]	.112	\$310.00							
Primus XP UL 437 - 1-1/2" length		20-593-112-XP	.[Finish]	.112	\$310.00							

Note: 1-1/2" cylinders support 1-3/4" through 2-1/4" door thickness.  
 1-3/4" thick door a 1-3/8" cylinder can be used by designating 138 in place of 112 in table above.

CYLINDER HOUSING WITHOUT CORE		Available finishes										
		605	606	609	612	613	619	622	625	626	643e	626AM
		▪	▪	▪	▪	▪	▪	▪	▪	▪	▪	N/A
Cylinder type		Specify			Price each							
		Part number	Finish	Cyl. Length								
FSIC (Full size interchangeable core)		30-016	.[Finish]	.112	\$102.00							
SFIC (Small format interchangeable core) <sup>1,2</sup>		80-108	.[Finish]	.138	\$109.00							

1. Cylinders include compression spring.
2. Not available for 2-1/4" door thickness.



605	606	612	619	622	625	626	643E	626AM
US3	US4	US10	US15	US19	US26	US26D	US11	-

## PARTS AND ACCESSORIES

## MORTISE CHASSIS AND WIRE HARNESES

Description	Specify	Price each
Chassis with harness (MS and MB only)	L483-000	\$1,205.00
Chassis with harness (MD only)	L483-001	\$1,454.00
Chassis harness with RX module switch	L483-007	\$154.00
Reader harness	L483-018	\$45.00
DPS kit (external, MD only) Contains: magnet, switch, and harness	L483-055	\$55.00

## DOOR PARTS

Description	Specify	Price each
(2) Spacers for ANSI A115.1 metal door preparations	L283-029	\$55.10

## KNOB PARTS

Description	Specify	Price each
(1) Pack of truarc ring, (2) spacer, knobs	K110-550	\$13.10
Mounting plate, inside knob	L583-321	\$11.00

## LEVER PARTS

Description	Specify	Price each
Pack of 20 truarc rings, levers	L283-030	\$33.00
(1) Mounting post (ferrule) for 1-3/4" door thickness	L583-212	\$17.50
(1) Mounting post (ferrule) for 2" door thickness	L583-213	\$17.50
(1) Mounting post (ferrule) for 2-1/4" door thickness	L583-214	\$17.50
Mounting plate, inside lever	L283-031	\$29.70
Spring cage (1 required per lever)	L283-040	\$14.70
Mounting plate screw (2 required per lock)	L583-066	\$17.50
Spindles and springs for 1-3/4" to 1-7/8" doors (2 each)	L283-198	\$23.80
Spindles and springs for 2" to 2-1/4" doors (2 each)	L283-199	\$28.10
Spindle and spring for 1-3/4" to 1-7/8" doors (qty: 1 - 2 required per lock)	L283-060	\$11.90
Spindle and spring for 2" to 2-1/4" doors (qty: 1 - 2 required per lock)	L283-061	\$14.70



605	606	612	619	622	625	626	643E	626AM
US3	US4	US10	US15	US19	US26	US26D	US11	-

**PARTS AND ACCESSORIES**

SCREW PACKS		Available finishes									
		605	606	612	613	619	622	625	626	643e	626AM
		▪	▪	▪	N/A	▪	N/A	▪	▪	▪	▪
Description	Contents	Specify		Price each							
		Part number	Finish								
Greenwich screw pack	(2) Reader-mount screws (not finished) (1) Tamper-resistant battery screw (1) Battery cover washer	L483-047	-	\$20.00							
Addison screw pack	(1) Each Philips and tamper-resistant bottom screw (2) Reader-mount screws (not finished) (1) Tamper-resistant battery screw (1) Battery cover washer	L483-048	.[Finish]	\$32.00							
Lock case screws	(2) C603-256, #12-24 WMS PFH	C203-736	-	\$10.00							
Strike screws	(2) C603-256, #12-24 WMS PFH.	C203-736	-	\$10.00							
Armor front screws	(2) K510-210, #8-32 x 1/4" MS PFH	K110-020	-	\$4.80							
Battery cover screw (10 pack)	(10) 24361818 battery cover screw, #4-40 x 1/4" PH (10) L783-036 battery cover captive washer	L483-066	-	\$31.00							

\* Consult Customer Care.

CHASSIS TORX® SCREW PACKS		Available finishes									
		605	606	612	613	619	622	625	626	643e	626AM
		▪	▪	▪	N/A	▪	N/A	▪	▪	▪	▪
Description	Contents	Specify		Price each							
		Part number	Finish								
Tamper-resistant Torx screw pack for standard L screws	(2) Armor screws, #8-32 x 1/4" (T-15) (2) Strike screws, #12-24 x 1/2" (T-20) (1) Each T-15 and T-20 installation tool	L283-121	-	\$33.40							
Backplate screw pack with grounding spring	(1) L783-029, grounding spring (6) F605-416, #6-32 x 3/8" TFH	L483-048	.[Finish]	\$32.00							



605	606	612	619	622	625	626	643E	626AM
US3	US4	US10	US15	US19	US26	US26D	US11	-

**PARTS AND ACCESSORIES**

<b>INSTALLATION TOOLS</b>		
<b>Description</b>	<b>Specify</b>	<b>Price each</b>
Universal clamp	40-286	\$688.00
L/LE Series installation template	40-248	\$604.00
Universal mortise door position switch (DPS) installation template (For use with only LE-MD lock)	40-291	\$224.00
Mortise pocket filler (edge)	40-158	\$268.00

The universal clamp above is necessary when using the remaining products to ensure hole placement accuracy. These installation tools function together and form a complete LE installation kit. The "Universal" (Clamp and DPS) products are for use in all CO, AD and LE product installations.

<b>ENGAGE™ WIRELESS TEST KIT AND ACCESSORIES</b>		
<b>Description</b>	<b>Specify</b>	<b>Price each</b>
TKE - ENGAGE™ Test kit. For use in pre-installation test applications. Comes with 2 TKE Transponders, ENGAGE gateway, tripod, TKE gateway bracket, battery, and backpack carry case	47271232	\$2,737.00
TKE Transponder	47269850	\$852.00
TKE Gateway bracket (Tripod adapter)	47269870	\$70.00

RESIDENTIAL ELECTRONIC

RESIDENTIAL MECHANICAL

COMMERCIAL WIRELESS ELECTRONIC

COMMERCIAL MECHANICAL/ELECTRIFIED

NDE MOBILE ENABLED WIRELESS CYLINDRICAL LOCK ■ OVERVIEW

**Standard features**



Certification	ANSI/BHMA Certified A156.25-2013, A156.2-2011, Series 4000, Grade 1, UL 294, UL 10C
Latch	1-1/8" x 2-1/4", Square corner faceplate, 1" housing diameter, 1/2" throw
Strike	1-1/4" x 4-7/8", ANSI Square corner, no box
Backset	2-3/4"
Cylinder	6-pin solid brass, keyed 6-pin, S123 keyway, keyed different (KD)
Door range	Comes set for 1-3/4" thick doors. Can be field adjusted for doors 1-5/8"-2" thick
Keys	Two nickel silver cut keys per lock, 6-pin, S123 section

**Finish codes and descriptions**

BHMA code	Description
605 (US 3)	Bright Brass
606 (US 4)	Satin Brass
612 (US 10)	Satin Bronze
619 (US 15)	Satin Nickel
622 (US 19)	Matte Black
625 (US 26)	Bright Chromium Plated
626 (US 26D)	Satin Chrome
626AM	Satin Stainless Steel, Antimicrobial (A)
643e (US 11)	Aged Bronze



06 (Rhodes)



07 (Athens)



17 (Sparta)

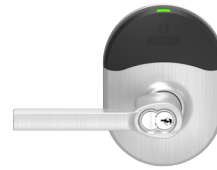

LAT (Latitude)

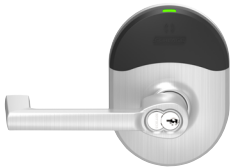

LON (Longitude)

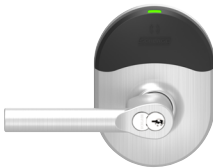

M52 (Broadway)

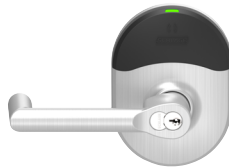

M81 (Boardwalk)

**CONTACT INFORMATION FOR NDE LOCKS AND DEVICES**

Payment Address: Schlage Electronic Security  
15934 Collections Center Drive  
Chicago, IL 60693

Customer service	Technical support
<ul style="list-style-type: none"> <li>Order status</li> <li>Credit returns of non-defective products</li> <li>General sales questions</li> </ul> <p>Email orders to: Allegion_Orders@allegion.com</p>	<ul style="list-style-type: none"> <li>Technical questions/issues</li> <li>Returns of defective products</li> <li>Repairs</li> </ul> <p>Contact for technical assistance: Electronic_Lock_TechProdSupport@allegion.com</p>

**FUNCTIONS**

ANSI/BHMA Certified A156.25-2013, A156.2-2011, Series 4000, Grade 1, UL 294, UL 10C

NDEB AND NDEBSI - INTERIOR PUSH BUTTON (FUNCTION SELECTABLE VIA ENGAGE™ MOBILE APP)	
<b>Storeroom/ Classroom</b>	Lockset is normally secure with outside lever disengaged. Valid normal credential or key momentarily unlocks door. Valid toggle credential may be used to change to a passage or secured state. Interior push button on inside housing confirms state of the lock via LED indicator. A mechanical key will retract the latch. Inside lever always allows free egress.
<b>Office</b>	Lockset is normally secure with outside lever disengaged. Valid normal credential or key momentarily unlocks door. Valid toggle credential may be used to change to a passage or secured state. Interior push button on inside housing can be used to select a passage or secured state and confirms state of the lock via LED indicator. A mechanical key will retract the latch. Inside lever always allows free egress. Meets the need for lockdown function for safety and security.
<b>Privacy</b>	Lockset is normally secure with outside lever disengaged. Valid normal credential or key momentarily unlocks door. Valid toggle credential may be used to change to a passage or secured state. Interior pushbutton on inside housing may be used to select a privacy status. The interior pushbutton will disable normal electronic access from the exterior and confirms state of the lock via LED indicator. Opening the door or pressing the interior pushbutton a second time on the inside housing deactivates the privacy status. A mechanical key will always retract the latch. Inside lever always allows free egress. Door position sensor required for function.
<b>Apartment</b>	Lockset is normally secure with outside lever disengaged. Valid normal or toggle credential is used to change to a passage or secured state. Interior pushbutton on inside housing may be used to select a passage or secured state and confirms state of the lock via LED indicator. Opening the door or pressing the interior pushbutton a second time causes the lockset to toggle to passage. While in passage mode, the lockset can only be secured while the door is closed by pressing the interior pushbutton or using a normal credential on the exterior. A mechanical key will retract the latch. Inside lever always allows free egress. Door position sensor required for function.

CYLINDERS	
<b>P6</b>	Conventional 6-pin cylinder
<b>Z</b>	Everest SL Conventional cylinder, 7-pin
<b>L</b>	Less conventional cylinder
<b>R</b>	FSIC (Full size interchangeable core)
<b>T</b>	FSIC - Construction core <sup>2</sup>
<b>J</b>	Less FSIC
<b>G</b>	SFIC (Small format interchangeable core) 7-pin
<b>H</b>	Refundable Construction SFIC <sup>2</sup>
<b>BDC</b>	Disposable SFIC
<b>B</b>	Less SFIC
<b>J-MED</b> ⓘ	Less FSIC - Medeco® (ATH, SPA, RHO and TLR only)
<b>J-CO6</b> ⓘ	Less FSIC – Corbin Russwin® (6-pin) (ATH, SPA, RHO, and TLR only)
<b>J-CO7</b> ⓘ	Less FSIC – Corbin Russwin (7-pin) (SPA only)
<b>J-SAR</b> ⓘ	Less FSIC – Sargent® (ATH, SPA, RHO, and TLR only)
<b>J-YA6</b> ⓘ	Less FSIC – Yale® 1210 or Medeco 31*0100 (6-pin) (ATH, SPA, RHO, and TLR only)
<b>J-YA7</b> ⓘ	Less FSIC – Yale (7-pin) (SPA only)
<b>L-SAR</b> ⓘ	Less Conventional, Sargent (ATH, SPA, RHO, and TLR only)
<b>L-COR</b> ⓘ	Less Conventional, Corbin Russwin (ATH, SPA, RHO, and TLR only)

ⓘ Extended lead time

1. Competitor lever designs come in finishes 626 standard, and 605, 606, 612, 619, 625, 643e, and 626AM with extended lead times.
2. For P, R, and G -Master Keyed cylinders can be specified and will be shipped in lock packaging.
3. For Master Key System Summary form which should accompany the master keyed order, see SES price book.
4. For Master Keying, additional line item 50-210 is required for Classic and Everest cylinders.
5. Control Keys for installation/removal of interchangeable cores are not furnished and must be ordered separate.
6. Spring cages and tailpieces are different based on the type of cylinder and chassis selected. Please see the NDE Series Parts Guide for more information.
7. The NDE Lock accepts many popular models of standard, SFIC, and FSIC cylinders. See SES pricebook for specific configurations.
8. For additional assistance on Master Keying, as well as restricted keyways, please contact your local sales representative.

RESIDENTIAL ELECTRONIC  
RESIDENTIAL MECHANICAL  
COMMERCIAL WIRELESS ELECTRONIC  
COMMERCIAL MECHANICAL/ELECTRIFIED



**LEVER DESIGNS**

**ATHENS (ATH)**

Tactile option: 8AT (milled)

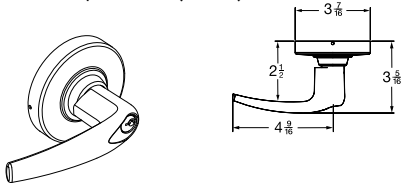

**BOARDWALK (BRK)**

Tactile option: 8BK (knurled)

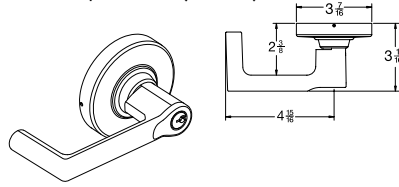

**BROADWAY (BRW)**

Tactile option: 8BY (knurled)

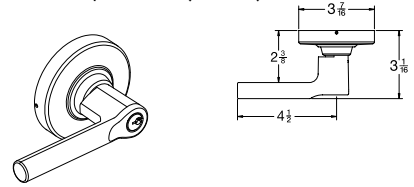

**LATITUDE (LAT)**

Tactile option: 8LT (milled)

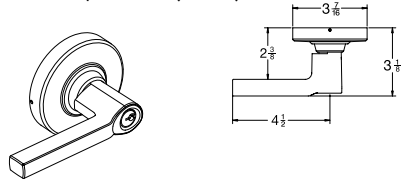

**LONGITUDE (LON)**

Tactile option: 8LN (milled)

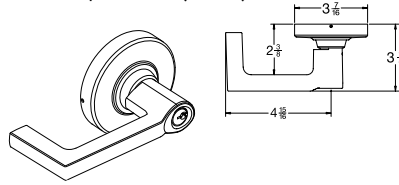

**OMEGA (OME)**

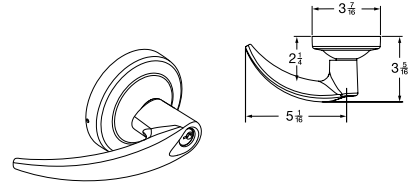

**RHODES (RHO)**

Tactile option: 8RO (milled)

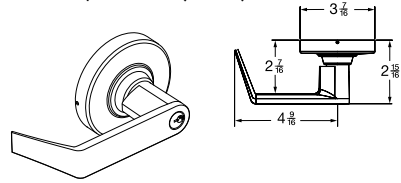

**SPARTA (SPA)**

Tactile option: 8SP (milled)

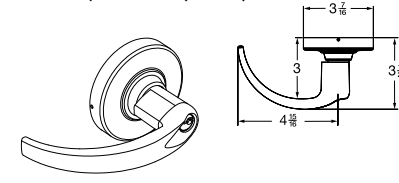

**TUBULAR (TLR)**

Tactile option: 8TR (knurled)

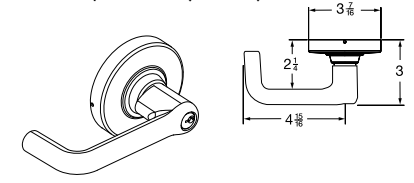

**TACTILE OPTIONS**

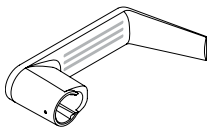

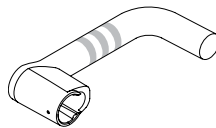

Typical pattern for 8AT, 8LT, 8LN, 8RO, 8SP

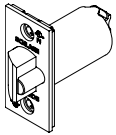
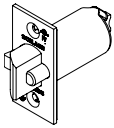
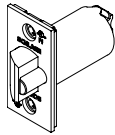
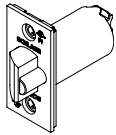

Typical pattern for 8BK, 8BW, 8TR

COMMERCIAL LEVER SUITING							
NDE Levers	AD/CO Levers	ND Levers	L Lock Levers	98/99 Exit	ALX Lock	S Lock	F Lock
Athens	Athens	Athens	07	07	Athens	Jupiter	-
Sparta	Sparta	Sparta	17	17	Sparta	Neptune	Jazz
Rhodes	Rhodes	Rhodes	06	06	Rhodes	Saturn	Elan
Tubular	-	Tubular	-	-	Tubular	-	-
Omega	-	Omega	-	-	Omega	-	-
Latitude	-	Latitude	Latitude	Latitude	Latitude	-	Latitude
Longitude	-	Longitude	Longitude	Longitude	Longitude	-	-
Broadway	-	Broadway	-	-	Broadway	-	-
Boardwalk	-	Boardwalk	-	-	Boardwalk	-	-

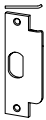
LATCHES			
<b>Deadlatch, 13-247</b> 	<b>Anti-friction fire door Deadlatch, 14-042</b> 	<b>Deadlatch, 14-047</b> 	<b>Deadlatch, 14-048</b> 

STRIKES	
<b>ANSI Strike 47267101</b> 	<b>T Strike, 10-013</b> 

605	606	612	619	622	625	626	643E	626AM
US3	US4	US10	US15	US19	US26	US26D	US11	-

**CYLINDRICAL**

**NDE MOBILE ENABLED WIRELESS LOCK**



NDE

1. Select product series		Price
NDEB	Mobile enabled cylindrical lock (with interior pushbutton with indicator) with Vandlgard	\$1,457.00
NDEBSI	Mobile enabled cylindrical lock with HID credential secure sector compatibility (with interior pushbutton with indicator) with Vandlgard	\$1,612.00

2. Select cylinder type		Price adjustment	
		Open	Restricted
<input type="checkbox"/> ● P6	With Cylinder, Schlage® - (Everest 29 S123, 6-pin KIL standard)	No charge	\$31.00
● Z	With Cylinder, Schlage - Everest SL, 6-pin KIL (factory master keyed only)	N/A	\$31.00
L	Less Cylinder, Schlage, 6-pin KIL	-\$94.00	-\$94.00
<input type="checkbox"/> ● R	With Cylinder, Schlage 6-pin (Everest 29 S123 standard) FSIC	\$106.00	\$137.00
J	Less Cylinder, Schlage, 6-pin FSIC	-\$55.00	-\$55.00
T	FSIC construction core	\$106.00	N/A
<input type="checkbox"/> ● G	SFIC with cylinder, Schlage 7-pin (Everest 29R standard) (factory master keyed only)	N/A	\$118.00
B	Less SFIC, Schlage, Falcon®, competitive OEM's, 7-pin	-\$55.00	-\$55.00
⊙ L-CO6	Less Cylinder, Corbin Russwin® KIL, 6-pin KIL	No charge	No charge
⊙ L-SAR	Less Cylinder, Sargent® (10L + 11L), 6-pin KIL	No charge	No charge
⊙ J-SAR	Less Cylinder, Sargent 6300, 6-pin FSIC	No charge	No charge
⊙ J-CO6	Less Cylinder, Corbin® 8000, 6-pin FSIC	No charge	No charge
⊙ J-CO7	Less Cylinder, Corbin 8000-7, 7-pin FSIC, (Only RHO, 8RO, SPA, 8SP)	No charge	No charge
⊙ J-MED	Less Cylinder, Medeco® 32*0201, 6-pin FSIC (Only RHO, 8RO, SPA, 8SP lever styles)	No charge	No charge
⊙ J-YA6	Less Cylinder, Yale® 1210 or Medeco 31*0100, 6-pin FSIC	No charge	No charge
⊙ J-YA7	Less Cylinder, Yale 1220, 7-pin FSIC (Only RHO, 8RO, SPA, 8SP lever styles)	No charge	No charge
H	SFIC construction core	\$32.00	\$32.00
BDC	SFIC disposable	-\$55.00	N/A
50-231	Construction core handling charge (non-refundable)	\$15.20	\$15.20

- Master Keyed cylinders can be specified and will be shipped in lock packaging. For Master Keying System Summary form which should accompany the master keyed order, see SES price book.
  - △ For master keying, an additional charge of \$29.40 each applies. Specify line item 50-210.
  - Control keys for installation/removal of interchangeable cores are not furnished and must be ordered separate.
  - ⊙ Not available on BRK, BRW, LAT, or LON.
- For additional assistance on Master Keying as well as restricted keyways, please contact customer service.

3. Select outside lever		Price adjustment
LLL	Less each lever	-\$35.50
Standard options	SPA (Sparta), RHO (Rhodes), ATH (Athens), TLR (Tubular), OME (Omega), BRW (Broadway), BRK (Boardwalk), LAT (Latitude), LON (Longitude)	No charge
Tactile options	(8AT, 8LT, 8LN, 8RO, 8SP, 8BK, 8BW, 8TR)	\$70.00

Note: Credentials available, see SES price book for more information.

4. Select outside finish		Price adjustment
626	Satin Chrome	No charge
605	Bright Brass	\$89.00
606	Satin Brass	\$89.00
612	Satin Bronze (00C rose not available in 612 finish)	\$89.00
619	Satin Nickel	\$89.00
622	Matte Black	\$89.00
625	Bright Chrome	\$89.00
643e	Aged Bronze	\$89.00
626AM	Satin Chrome Antimicrobial	\$128.00

⊘ Extended lead time on all finishes except 626.

5. Select inside lever (Specify only if different from outside lever)		Price adjustment
LLL	Less each lever	-\$35.50
Standard options	SPA (Sparta), RHO (Rhodes), ATH (Athens), TLR (Tubular), OME (Omega), BRW (Broadway), BRK (Boardwalk), LAT (Latitude), LON (Longitude)	No charge
Tactile options	(8AT, 8LT, 8LN, 8RO, 8SP, 8BK, 8BW, 8TR)	\$70.00

Note: Credentials available, see SES price book for more information.



605	606	612	619	622	625	626	643E	626AM
US3	US4	US10	US15	US19	US26	US26D	US11	-

**CYLINDRICAL**

**NDE MOBILE ENABLED WIRELESS LOCK**

<b>6. Select inside finish (Specify only if different from outside finish)<sup>1</sup></b>		<b>Price adjustment</b>
626	Satin Chrome	No charge
605 <sup>(K)</sup>	Bright Brass	\$89.00
606 <sup>(K)</sup>	Satin Brass	\$89.00
612 <sup>(K)</sup>	Satin Bronze	\$89.00
619 <sup>(K)</sup>	Satin Nickel	\$89.00
622 <sup>(K)</sup>	Matte Black	\$89.00
625 <sup>(K)</sup>	Bright Chrome	\$89.00
643e <sup>(K)</sup>	Aged Bronze	\$89.00
626AM <sup>(K)</sup>	Satin Chrome Antimicrobial	\$128.00

- 1. Charge only applies if outside finish is 626 and you are specifying a different inside finish.
- <sup>(K)</sup> Extended lead time on all finishes except 626.

<b>7. Select backset and latch bolt</b>		<b>Price adjustment</b>
LLL	Less Latch	-\$54.00
13-247	2-3/4" Backset, deadlatch, square corner, 1-1/8" x 2-1/4"	Standard
14-042	2-3/4" Backset, deadlatch anti-friction fire door latch, square corner	\$279.00
14-047	2-3/8" Backset, deadlatch square corner, 1-1/8" x 2-1/4"	No charge
14-048	2-3/8" Backset, deadlatch square corner, 1" x 2-1/4"	No charge

<b>8-9. Select strike plate and strike lip length</b>		<b>Price adjustment</b>
47267101 <sup>2,3</sup>	1-3/16" Lip, ANSI, no box, 1-1/4" x 4-7/8" (10-025 with retained screws)	Standard
10-016 <sup>3</sup>	1-1/8" Lip, square corner, T-strike, fire door latch	\$27.00
C603-623	Dust box for T-strike, 10-013	No charge
B502-853	Deep dust box for T-strike, 10-016	No charge
K510-066	Box for ANSI strike (Must be specific)	No charge

- 2. 1-3/8" Lip available, must specify 1-3/8" Lip. List add \$44.00.
- 3. DPS magnet requires prep and install beneath strike.
- 4. 1-1/2" Lip available, must specify 1-1/2" Lip. List add \$44.00.

<b>10. Select keying type</b>		<b>Price adjustment</b>
<b>Open keyway families: KIL or FSIC<sup>5</sup></b>		
S123	Everest 29 S (Key in Lever or FSIC)	Standard
C123	Everest C	No charge
C/CE/E/EF/F/FG/G	Classic Obverse	No charge
<b>Restricted keyway families: KIL or FSIC<sup>5,6</sup></b>		
29 T	Everest 29 T	\$31.00
D	Everest D	\$31.00
Classic Restricted	Quad, Numbered, Reverse	\$31.00
<b>Restricted keyway families: SFIC<sup>7</sup></b>		
29R	Everest 29 R	No charge
B	Everest B	No charge

- 5. Full size key systems (Everest 29 S and T, Everest C and D, Obverse and Quad) are available in Primus and Primus XP key system and must be ordered separately. Lock should be ordered less cylinder and Primus cylinder should be a separate line.
- 6. Everest restricted keyways require a Letter of Authorization to be submitted with the order. See SES price book for sample Letter of Authorization.
- 7. Master keyed cylinders can be specified and will be shipped in lock packaging. For Master Keying System Summary form which should accompany the master keyed order, see SES price book.



605	606	612	619	622	625	626	643E	626AM
US3	US4	US10	US15	US19	US26	US26D	US11	-

**PARTS AND ACCESSORIES**

OUTSIDE ESCUTCHEON SUBASSEMBLY		Available finishes									
		605	606	612	613	619	622	625	626	643e	626AM
		▪	▪	▪	N/A	▪	N/A	▪	▪	▪	▪
Description	Contents	Specify			Price each						
		Part number	Finish								
Outside escutcheon subassembly (without reader PCBA)	(3) #6-32 x .25 FH PD TC screws (1) Outside RF window assembly (1) Outside backplate	(1) Outside escutcheon (1) Adjustment spring	N223-045	.[Finish]	\$161.00						

INSIDE ESCUTCHEON SUBASSEMBLY		Available finishes									
		605	606	612	613	619	622	625	626	643e	626AM
		▪	▪	▪	N/A	▪	N/A	▪	▪	▪	▪
Description	Contents	Specify			Price each						
		Part number	Finish								
NDEB Inside escutcheon assembly (with main PCBA) - <b>Upgrades NDE80 product</b>	(1) Inside escutcheon (1) Door position sensor (1) Inside label	(1) RF window (1) Main PCB module	47278749	.[Finish]	\$716.00						
Inside battery cover	(1) Battery cover		N623-007	.[Finish]	\$59.00						

READER PCBA		
Description	Specify	Price each
Reader PCBA (Does not support HID secure sector compatibility)	N223-046	\$534.00

BATTERY HOLDER KIT			
Description	Contents	Specify	Price each
Battery holder kit	(1) Battery tray assembly (1) Battery strap	N223-044	\$40.00

LEVERS AND RELATED COMPONENTS		Available finishes									
		605	606	612	613	619	622	625	626	643e	626AM
		▪	▪	▪	N/A	▪	N/A	▪	▪	▪	▪
Description		Specify			Price each						
		Part number	Lever style	Finish							
FSIC Core driver		N523-127	-	.[Finish]	\$4.50						
SFIC Core driver		N523-091	-	.[Finish]	\$18.10						
SFIC Core driver and spacer		09-774	-	.[Finish]	\$22.40						
SFIC Core spacer - Spacer required for 6-pin, no spacer required for 7-pin		D500-000	-	.[Finish]	\$2.60						
New product manufactured on or after February 1, 2017 (reference serial number label on product)											
Lever - Closed; ATH, RHO, SPA, OME, TLR		03-230	.[Lever]	.[Finish]	\$206.00						
Lever - Closed; 8AT, 8RO, 8SP, 8TR		03-230	.[Lever]	.[Finish]	\$276.00						
Lever - Cylinder - Schlage KIL; ATH, RHO, SPA		03-231	.[Lever]	.[Finish]	\$206.00						
Lever - Cylinder - Schlage FSIC; ATH, RHO, SPA		03-232	.[Lever]	.[Finish]	\$206.00						
Lever - Cylinder - Schlage SFIC; ATH, RHO, SPA		03-200	.[Lever]	.[Finish]	\$206.00						
Lever - Cylinder - Schlage SFIC - Broadway		47258039	-	.[Finish]	\$206.00						
Lever - Cylinder - Schlage SFIC - Boardwalk		47258040	-	.[Finish]	\$206.00						
Lever - Cylinder - Schlage SFIC - Latitude		47258041	-	.[Finish]	\$206.00						
Lever - Cylinder - Schlage SFIC - Longitude		47258042	-	.[Finish]	\$206.00						
Lever - Cylinder - Schlage SFIC - Broadway (Tactile)		47260537	-	.[Finish]	\$276.00						



Commercial wireless electronic/electrified locks, readers and devices

605	606	612	619	622	625	626	643E	626AM
US3	US4	US10	US15	US19	US26	US26D	US11	-

PARTS AND ACCESSORIES

LEVERS AND RELATED COMPONENTS	Available finishes									
	605	606	612	613	619	622	625	626	643e	626AM
	▪	▪	▪	N/A	▪	N/A	▪	▪	▪	▪
Description	Specify			Price each						
	Part number	Lever style	Finish							
Lever - Cylinder - Schlage SFIC - Boardwalk (Tactile)	47260538	-	[Finish]	\$276.00						
<b>New product manufactured on or after February 1, 2017 (reference serial number label on product)</b>										
Lever - Cylinder - Schlage SFIC - Latitude (Tactile)	47260539	-	[Finish]	\$276.00						
Lever - Cylinder - Schlage SFIC - Longitude (Tactile)	47260540	-	[Finish]	\$276.00						
Lever - Closed - Broadway	47258043	-	[Finish]	\$206.00						
Lever - Closed - Boardwalk	47258044	-	[Finish]	\$206.00						
Lever - Closed - Latitude	47258045	-	[Finish]	\$206.00						
Lever - Closed - Longitude	47258046	-	[Finish]	\$206.00						
Lever - Closed - Broadway (Tactile)	47260541	-	[Finish]	\$276.00						
Lever - Closed - Boardwalk (Tactile)	47260542	-	[Finish]	\$276.00						
Lever - Closed - Latitude (Tactile)	47260543	-	[Finish]	\$276.00						
Lever - Closed - Longitude (Tactile)	47260544	-	[Finish]	\$276.00						
Lever - P, Z, L - Broadway	47258047	-	[Finish]	\$206.00						
Lever - P, Z, L - Boardwalk	47258048	-	[Finish]	\$206.00						
Lever - P, Z, L - Latitude	47258049	-	[Finish]	\$206.00						
Lever - P, Z, L - Longitude	47258050	-	[Finish]	\$206.00						
Lever - P, Z, L - Broadway (Tactile)	47260545	-	[Finish]	\$276.00						
Lever - P, Z, L - Boardwalk (Tactile)	47260546	-	[Finish]	\$276.00						
Lever - P, Z, L - Latitude (Tactile)	47260547	-	[Finish]	\$276.00						
Lever - P, Z, L - Longitude (Tactile)	47260548	-	[Finish]	\$276.00						
Lever FSIC R, J, T - Broadway	47258051	-	[Finish]	\$206.00						
Lever FSIC R, J, T - Boardwalk	47258052	-	[Finish]	\$206.00						
Lever FSIC R, J, T - Latitude	47258053	-	[Finish]	\$206.00						
Lever FSIC R, J, T - Longitude	47258054	-	[Finish]	\$206.00						
Lever FSIC R, J, T - Broadway (Tactile)	47260549	-	[Finish]	\$276.00						
Lever FSIC R, J, T - Boardwalk (Tactile)	47260550	-	[Finish]	\$276.00						
Lever FSIC R, J, T - Latitude (Tactile)	47260551	-	[Finish]	\$276.00						
Lever FSIC R, J, T - Longitude (Tactile)	47260552	-	[Finish]	\$276.00						

RESIDENTIAL ELECTRONIC

RESIDENTIAL MECHANICAL

COMMERCIAL WIRELESS ELECTRONIC

COMMERCIAL MECHANICAL/ELECTRIFIED

605	606	612	619	622	625	626	643E	626AM
US3	US4	US10	US15	US19	US26	US26D	US11	-

**PARTS AND ACCESSORIES**

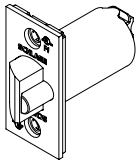
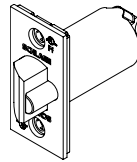
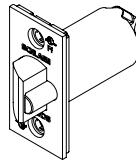
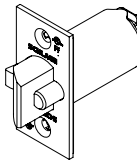
LATCHES AND RELATED COMPONENTS																								
DEADLATCH <sup>1</sup>																								
																								
Available finishes																								
<table border="1"> <tr> <td>605</td> <td>606</td> <td>612</td> <td>613</td> <td>619</td> <td>622</td> <td>625</td> <td>626</td> <td>643e</td> <td>626AM</td> </tr> <tr> <td>▪</td> <td>▪</td> <td>▪</td> <td>N/A</td> <td>▪</td> <td>N/A</td> <td>▪</td> <td>▪</td> <td>▪</td> <td>N/A</td> </tr> </table>					605	606	612	613	619	622	625	626	643e	626AM	▪	▪	▪	N/A	▪	N/A	▪	▪	▪	N/A
605	606	612	613	619	622	625	626	643e	626AM															
▪	▪	▪	N/A	▪	N/A	▪	▪	▪	N/A															
Description	Backset	Specify		Price each																				
		Part number	Finish																					
Square corner, 1-1/8" x 2-1/4"	2-3/8"	14-047	.[Finish]	\$83.70																				
Square corner, 1" x 2-1/4"	2-3/8"	14-048	.[Finish]	\$83.70																				
Square corner, 1-1/8" x 2-1/4"	2-3/4"	13-247	.[Finish]	\$130.00																				
Anti-friction fire door latch 1" square corner, 1-1/8" x 2-1/4", 3/4" throw	2-3/4"	14-042	.[Finish]	\$536.00																				

<sup>1</sup> All latches require reinforcement when used in hollow metal door applications.

STRIKES		Available finishes									
		605	606	612	613	619	622	625	626	643e	626AM
		▪	▪	▪	N/A	▪	N/A	▪	▪	▪	N/A
Description	Contents	Specify		Price each							
		Part number	Finish								
1-3/16" - ANSI, no box, 1-1/4" x 4-7/8"	(1) ANSI strike	10-025	.[Finish]	\$66.40							
Box for ANSI strike	(1) Standard box	K510-066	-	\$10.10							

COMPETITOR CORE/COMPATIBILITY PARTS																								
⌘ Extended factory lead time																								
Available finishes																								
<table border="1"> <tr> <td>605</td> <td>606</td> <td>612</td> <td>613</td> <td>619</td> <td>622</td> <td>625</td> <td>626</td> <td>643e</td> <td>626AM</td> </tr> <tr> <td>⌘</td> <td>⌘</td> <td>⌘</td> <td>N/A</td> <td>⌘</td> <td>N/A</td> <td>⌘</td> <td>▪</td> <td>⌘</td> <td>N/A</td> </tr> </table>					605	606	612	613	619	622	625	626	643e	626AM	⌘	⌘	⌘	N/A	⌘	N/A	⌘	▪	⌘	N/A
605	606	612	613	619	622	625	626	643e	626AM															
⌘	⌘	⌘	N/A	⌘	N/A	⌘	▪	⌘	N/A															
New product manufactured on or after February 1, 2017 (reference serial number label on product)																								
Description	Specify			Price each																				
	Part number	Lever style	Finish																					
Lever - Cylinder - Corbin Russwin KIL (L-CO6); ATH, RHO, SPA, TLR	03-234	.[Lever]	.[Finish]	\$379.00																				
Lever - Cylinder - Corbin Russwin 7-pin FSIC (J-CO7); RHO	03-235	.[Lever]	.[Finish]	\$379.00																				
Lever - Cylinder - Yale 7-pin FSIC (J-YA7); RHO	03-236	-	.[Finish]	\$379.00																				
Lever - Cylinder - Medeco 32 (J-MED); ATH, RHO, SPA, TLR	03-237	.[Lever]	.[Finish]	\$379.00																				
Lever - Cylinder - Sargent KIL (L-SAR); ATH, RHO, SPA, TLR	03-244	.[Lever]	.[Finish]	\$379.00																				
Lever - Cylinder - Medeco 31 or Yale 1210 6-pin FSIC (J-YA6); ATH, RHO, SPA, TLR	03-255	.[Lever]	.[Finish]	\$379.00																				
Lever - Cylinder - Corbin Russwin 6-pin FSIC (J-CO6); ATH, RHO, SPA, TLR	03-266	.[Lever]	.[Finish]	\$379.00																				
Lever - Cylinder - Sargent FSIC (J-SAR); ATH, RHO, SPA, TLR	03-277	.[Lever]	.[Finish]	\$379.00																				
Spring cage and lever catch assembly - Outside standard (P, L, Z, R, J, T, B, BDC, G, H, L-SAR, L-CO6, J-CO6, J-SAR, J-CO7)	N523-218	-	.[Finish]	\$105.00																				
Spring cage and lever catch assembly - Outside competitor cores (J-YA6, J-YA7, J-MED)	N523-224	-	.[Finish]	\$217.00																				
Tailpiece Sargent XC FSIC	XN12-292	-	.[Finish]	\$19.40																				



605	606	612	619	622	625	626	643E	626AM
US3	US4	US10	US15	US19	US26	US26D	US11	-

**PARTS AND ACCESSORIES**

<b>REINFORCEMENTS</b> (Must be used for hollow metal doors)			
Description	Specify		Price each
	Part number	Door thickness	
Metal door reinforcer kit, fits both 7/8" and 1" diameter housings. Specify door thickness, includes A501-567 and A501-565 or A501-566.	37-001	. [ ]	\$58.60
Latch spacer – fits 1" diameter latch housing and 1-3/4" hollow metal doors (steel and aluminum)	24483760	-	\$8.10
Reinforcer for 1-3/4" thick non-reinforced metal doors. Fits both 7/8" and 1" diameter housings.	A501-566	-	\$29.40

<b>MOTORIZED CHASSIS ASSEMBLY</b>			
Description	Contents	Specify	Price each
Motorized chassis assembly	(1) NDE Chassis subassembly (1) Main wire harness (1) Motor actuator subassembly	N223-007	\$374.00

<b>TAILPIECES</b>		
Description	Specify	Price each
Core driver - SCH SFIC	N523-091	\$18.10
Core driver - SCH FSIC	N523-127	\$4.50
Core driver - L-SAR	09-060	\$18.00
Core driver - J-YA6	09-061	\$18.00
Core driver - J-CO6	09-062	\$18.00
Core driver - J-SAR	09-063	\$18.00
Core driver - L-CO6	10-140	\$17.90
Core driver - J-CO7	10-141	\$34.20
Core driver - J-YA7	10-142	\$34.20
Core driver - J-MED	10-143	\$35.90
SFIC Core driver and spacer	09-774	\$22.40
SFIC Core spacer - Spacer required for 6-pin, no spacer required for 7-pin	D500-000	\$2.60
Tailpiece Sargent XC SFIC	XN12-292	\$19.40

<b>MAIN WIRE HARNESS</b>		
Description	Specify	Price each
Main wire harness	N223-019	\$57.00

<b>INSIDE BASEPLATE</b>		
Description	Specify	Price each
Inside baseplate	N623-000	\$40.00

New product manufactured on or after February 1, 2017 (reference serial number label on product)

<b>SPRING CAGES</b>		
Description	Specify	Price each
Spring cage and lever catch assembly - Outside standard (P, L, Z, R, J, T, B, BDC, G, H, L-SAR, L-CO6, J-CO6, J-SAR, J-CO7)	N523-218	\$105.00
Spring cage and lever catch assembly - Inside Less Cylinder	N523-221	\$73.50
Spring cage and lever catch assembly - Outside standard (J-YA7, J-YA6, J-MED)	N523-224	\$217.00





605	606	612	619	622	625	626	643E	626AM
US3	US4	US10	US15	US19	US26	US26D	US11	-

**PARTS AND ACCESSORIES**

DOOR POSITION SENSOR KIT	Specify	Price each
Door position sensor kit (Includes sensor with wire harness and connector, for NDEB only)	L483-055	\$55.00

CONVERSION KITS	Available finishes									
	605	606	612	613	619	622	625	626	643e	626AM
	▪	▪	▪	▪	▪	▪	▪	▪	▪	▪
Description	Specify					Price each				
	Part number	Function	Lever	Finish	Core (if applicable)					
Inside spring cage / lever conversion kit	40-400	.[Function]	.[Lever]	.[Finish]	.[Core]	\$330.00				
Outside spring cage / lever conversion kit	40-600	.[Function]	.[Lever]	.[Finish]	.[Core]	\$330.00				

Notes: All kits will contain a spring cage and lever. Some kits will contain a button or tailpiece. Kits are limited to previously offered product - KIL, FSIC, SFIC, L-SAR, J-SAR, J-CO6, J-YA6.

SCREWS				Available finishes									
PH = Phillips head POH machine = Phillips oval head PFH = Phillips flat head				605	606	612	613	619	622	625	626	643e	626AM
				▪	▪	▪	N/A	▪	N/A	▪	▪	▪	N/A
Size	Type	Description	Door thickness	Specify		Price each							
				Part number	Finish								
12-24 x 1"	PFH Combo	ANSI strike	-	C603-256	.[Finish]	\$1.50							
#8 x 3/4"	PFH Combo	Latch and strike	-	C603-897	.[Finish]	\$1.40							
#10 x 32 x 2.425"	PFH Machine	Spring cage screws	1-3/8" – 2-1/8"	N523-021	.[Finish]	\$3.00							

Specify for listed parts (A501-171, L583-133, C603-256, C603-897).

SCREW PACKS				Available finishes									
				605	606	612	613	619	622	625	626	643e	626AM
				N/A	▪	▪	N/A	▪	N/A	▪	▪	▪	N/A
Description	Contents	Specify		Price each									
		Part number	Finish										
Latch and strike	(4) C603-897	B202-517	.[Finish]	\$12.30									
ANSI strike	(2) C603-256	C203-736	.[Finish]	\$10.00									
Mounting kit	(4) C603-897 (2) 96954557	(1) N523-108 (1) N623-049	(1) N623-048	N223-049 .[Finish]	\$21.00								

Specify for listed parts (B202-517, C203-736, N123-020).

TORX® SCREW PACKS				Available finishes									
Specify for listed parts (C203-311, C203-312)				605	606	612	613	619	622	625	626	643e	626AM
				▪	▪	▪	▪	▪	N/A	▪	▪	▪	N/A
Description	Contents	Specify		Price each									
		Part number	Finish										
Latch and strike <sup>1</sup>	(4) C503-766 (T-15)	C203-311	.[Finish]	\$32.00									
Latch and ANSI strike <sup>1</sup>	(2) C503-766 (T-15) (2) L583-371 (T-20)	C203-312	.[Finish]										

1. Torx screw packs are furnished with appropriate T-xx installation tool(s).



Commercial wireless electronic/electrified locks, readers and devices

605	606	612	619	622	625	626	643E	626AM
US3	US4	US10	US15	US19	US26	US26D	US11	-

**PARTS AND ACCESSORIES**

SCHLAGE NDE SERIES Cylinder reference table	Standard			Primus		Primus UL437	
	Part number	Open	Restricted	Part number	Price	Part number	Price
All functions	23-065	\$94.00	\$125.00	20-765	\$205.00	20-565	\$268.00
				20-765-XP	\$205.00	20-565-XP	\$268.00

Available finishes: 606, 626 (Specify for listed parts 23-065, 20-765/XP, 20-565/XP, 21-000).

ENGAGE™ WIRELESS TEST KIT AND ACCESSORIES		
Description	Specify	Price each
TKE - ENGAGE™ Test kit. For use in pre-installation test applications. Comes with 2 TKE Transponders, ENGAGE™ gateway, tripod, TKE gateway bracket, battery, and backpack carry case	47271232	\$2,737.00
TKE Transponder	47269850	\$70.00
TKE Gateway basket (Tripod adapter)	47269870	\$852.00

INSTALLATION TOOLS		
Description	Specify	Price each
Universal clamp (For use with all AD, CO, NDE, and LE Series installation templates)	40-286	See page 46
NDEB Door preparation template (Universal Clamp require to use this template)	47286225	\$961.00
Door position sensor fixture and mounting hardware (47286225 is required to use this fixture)	40-292	\$226.00

RESIDENTIAL ELECTRONIC

RESIDENTIAL MECHANICAL

COMMERCIAL WIRELESS ELECTRONIC

COMMERCIAL MECHANICAL/ELECTRIFIED

## CTE ENGAGE™ SINGLE DOOR CONTROLLER

The CTE is an ENGAGE™ enabled single opening controller that allows perimeter and common area openings to be managed in a single system along with Schlage Control® smart deadbolts, NDEB cylindrical, and LEB mortise wireless locks. It is ideal for Multifamily, commercial mixed use, and retail store front applications.

The CTE is designed to work with a Schlage® Mobile enabled multi-technology reader and interface with an electrified lock, electromagnetic lock, electric strike, automatic operator or exit device to control an opening.

**The CTE ENGAGE™ Single door controller with mobile enabled multi-technology reader kit can be used in a variety of applications; below are a few examples.** Please note: all components are sold separately.

ENGAGE™ cloud via mobile device or Wi-Fi, or Software Alliance Member (SAM) via Wi-Fi or GWE with IP to host

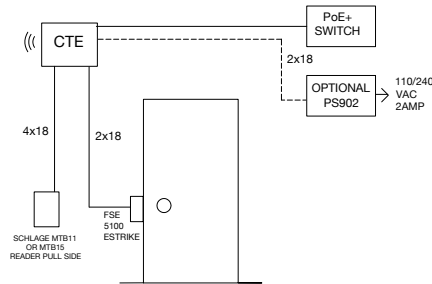

**Operation:** Presenting a valid credential to Schlage MTB XX reader will cause fail secure 5100 electric strike to release for authorized entrance. Free egress always.  
**Products:** We offer a variety of electric strikes from Locknetics™ and Von Duprin®, as well as Schlage Power Supplies to meet the specific needs of the opening.

ENGAGE™ cloud via mobile device or Wi-Fi, or Software Alliance Member (SAM) via Wi-Fi or GWE with IP to host

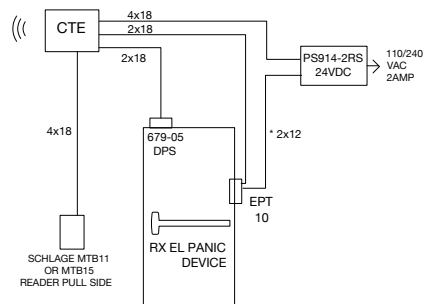

**Operation:** Presenting a valid credential to Schlage MTB XX will cause EL panic device to retract for authorized entrance. Free non-alarmed egress at all times.  
**Products:** We offer a variety of Falcon® and Von Duprin exit devices, and Von Duprin power supplies to meet the specific needs of the opening.

ENGAGE™ cloud via mobile device or Wi-Fi, or Software Alliance Member (SAM) via Wi-Fi or GWE with IP to host

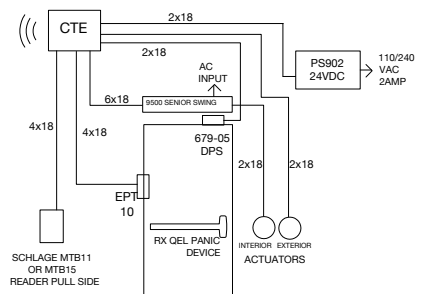

**Operation:** Presenting a valid credential to Schlage MTB XX will cause QEL panic device to retract for authorized entrance and enable exterior actuator. Free non-alarmed egress at all times. Interior actuator always active to retract QEL panic and open door.  
**Products:** We offer a variety of hardware and accessories from Von Duprin, LCN®, Schlage and Locknetics to meet the specific needs of the opening.

Certifications: UL 294 Indoor, FCC Part 15, NEMA Enclosure Indoor (Type 1, 4, and 4X), ULC S319 Indoor, RoHS

### How to order CTE Series

	REQUIRED FIELDS	COLOR	COVER STYLE
1. CTE	CTE	B	C2
2. Reader type	MTB15		
3. Reader cover color option			
4. Reader cover style			
MTB11	Mobile enabled multi-technology mullion mount		
MTB15	Mobile enabled multi-technology single gang wall mount		
B	Black (Standard for C1 and C2)		
C	Cream (Available for C1 cover only)		
C1	Legacy style cover (Black or Cream color options)		
C2	New style cover (Default cover; Black is only color option)		

CTE SERIES SINGLE DOOR CONTROLLER	Specify			Price
	Model No.	Color (optional)	Cover style	
CTE with Mobile enabled multi-technology mullion reader kit	CTE-MTB11	- [B=Black; C=Cream]	- [C1 or C2]	\$1,601.00
CTE with Mobile enabled multi-technology single reader kit	CTE-MTB15	- [B=Black; C=Cream]	- [C1 or C2]	\$1,601.00



RESIDENTIAL ELECTRONICS ACCESSORIES

ELECTROMAGNETIC LOCKS	Specify	Price (ea.)
500lb maglock	M420	\$887.00
High security 1500lb maglock	M490	\$1,110.00
High security 1500lb maglock - plus	M490P	\$1,436.00
Double mag lock 1500 lbs per leaf	M492	\$2,325.00
Anti-Tamper Switch (ATS), MBS indicator (LED) for M450P/M452P only	450/490-ATS-LED	\$124.00
Double mag lock with 1000 lbs holding force per leaf with MBS, DPS and RTD	M452P	\$2,801.00
Gate maglock	M490G	\$1,123.00
1000 lbs hold force single mag lock with MBS, DPS and RTD	M450P	\$1,349.00
Double mag lock with 1000 lbs hold force per leaf with MBS, DPS and RTD	M452P.ATS/LED-2	\$250.00
High security 1500lb delayed egress maglock - plus	M490DEP	\$3,582.00
High security 1500lb delayed egress maglock	M490DE	\$2,387.00
Mortise shear maglock	GF3000	\$1,778.00

RESIDENTIAL ELECTRONIC

RESIDENTIAL MECHANICAL

COMMERCIAL WIRELESS ELECTRONIC

COMMERCIAL MECHANICAL/ELECTRIFIED



ELECTRONIC LOCKING SYSTEMS

SCHLAGE NETWORKED READERS	Specify	Price (ea.)
Mobile enabled multi-technology reader - Wall mount	MTB15	\$420.00
Mobile enabled multi-technology reader - Mullion	MTB11	\$420.00
Mobile enabled multi-technology reader - Wall mount with keypad	MTKB15	\$678.00

ELECTRONICS ACCESSORIES	Specify	Price (ea.)
Motion Scanner/PIR - white	Scan II - W	\$855.00
Wood Door and Frame door position switch	679-05	\$97.00
Hollow Metal Door and Frame door position switch	679-05HM	\$134.00
Wood Door and Metal Frame door position switch	679-05WD	\$160.00
Concealed/Flush mount door position switch	7764	\$323.00
Surface mount door position switch	7766	\$343.00
Heavy duty SPDT maintained single direction keyswitch	653-04 SF-626	\$447.00
Heavy duty SPDT momentary single direction keyswitch	653-05 SF-626	\$447.00
18" x 3/8" Armored door cord with 26" 4-conductor wire	788C-18	\$188.00
12" x 1/2" Armored door cord	798-12	\$122.00
18" x 1/2" Armored door cord	798-18	\$154.00
Surface mini box SPDT momentary pushbutton	660-PB	\$230.00
Entry level pushbutton, red	701RD	\$217.00
Entry level pushbutton, 2" square, Illuminated Red "Push to Exit"	709RD EX ILL	\$253.00
Entry level pushbutton, 2" square, Illuminated Green "Push to Exit"	709GR EX ILL	\$253.00
Entry level pushbutton, 2" square, illuminated blue handicapped symbol	709BLH ILL	\$253.00
1-1/4" Heavy duty pushbutton, red "Push to Exit"	621RD EX SF-626	\$358.00
1-5/8" Heavy duty pushbutton, red "Push to Exit"	623RD EX SF-626	\$358.00
2-3/4" Heavy duty pushbutton, red "Push to Exit"	625RD EX SF-626	\$358.00
1-1/4" Heavy duty pushbutton, green "Push to Exit"	621GR EX SF-626	\$358.00
1-5/8" Heavy duty pushbutton, green "Push to Exit"	623GF EX SF-626	\$358.00
2-3/4" Heavy duty pushbutton, green "Push to Exit"	625GR EX SF-626	\$358.00
2-3/4" Heavy duty pushbutton, blue handicapped symbol	625BLH SF-626	\$358.00

POWER SUPPLY	Specify	Price (ea.)
2A @ 12/24 VDC - field selectable power supply	PS902	\$389.00
4A @ 12/24 VDC - field selectable power supply	PS904	\$735.00
4A (16A Inrush) @ 12/24 VDC - field selectable power supply	PS914	\$1,115.00
2 Relay EL/QEL Panic device control board	900-2RS	\$266.00
Emergency interface relay for fire alarm or emergency power cut	900-FA	\$96.00
Battery backup kit, includes PCB and 2 batteries	900-BBK	\$376.00

Note: Power Supplies default to Schlage pricing and discount.

## SCHLAGE B500 SINGLE CYLINDER DEADBOLT SERIES

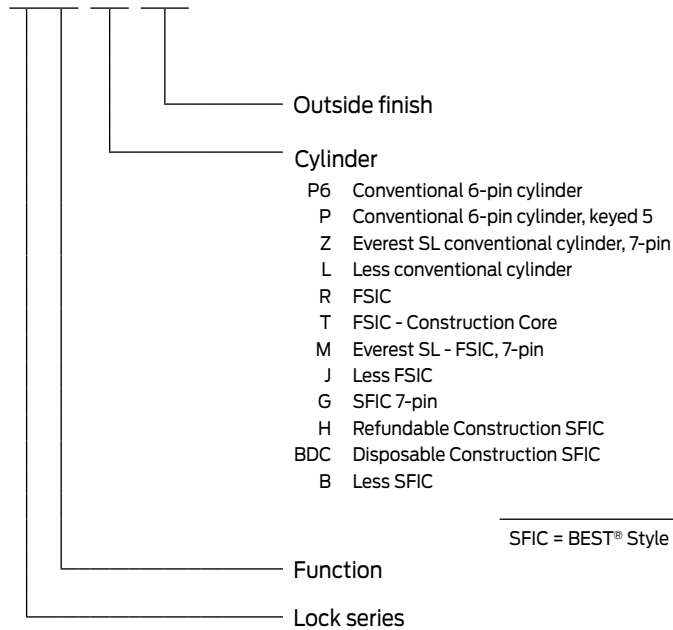
**Product identification**
**B560 . P6 . 626**

**Finish codes and descriptions**

BHMA code		Description
619	(US 15)	Satin Nickel
626	(US 26D)	Satin Chrome

**Standard features**

Certification	ANSI A156.36, 2010, Grade 2 (except B581). Available UL Listed for 3-hour fire door (except B562 and B571) With FSIC Interchangeable Core Cylinders: Grade 2; With SFIC Interchangeable Core Cylinders: Grade 3
Deadbolt	1" x 2-1/4", Square corner faceplate, 1" housing diameter, 1" throw
Strike	1-1/8" x 2-3/4", Square corner, box
Backset	Adjustable for 2-3/8" or 2-3/4"
Cylinder	6-Pin solid brass, keyed 6-pin, S123 keyway, keyed different (KD)
Door range	1-3/8"–1-7/8" standard cylinder or thumbturn only, 1-5/8"–2" interchangeable core cylinder
Keys	Two cut keys per lock, 6-pin, S123 section
Reinforcement	Metal dust box reinforcer with three - 3" screws
Trim rings	7/16" and 1/8" wrought brass or bronze, reinforced with security inserts

**B500 - SINGLE CYLINDER DEADBOLT SERIES**

Product	Finish	Latch	Strike	Cylinder	Price each
B560B	626	12-287	10-094	B - Less SFIC	\$176.00
B560P	626	12-288	10-094	6-pin (keyed 5) Schlage KD C	\$124.00
B560B	619	12-288	10-094	B - Less SFIC	\$182.00
B560P	619	12-287	10-094	6-pin (keyed 5) Schlage KD C	\$130.00

## CS210 INTERCONNECT SERIES

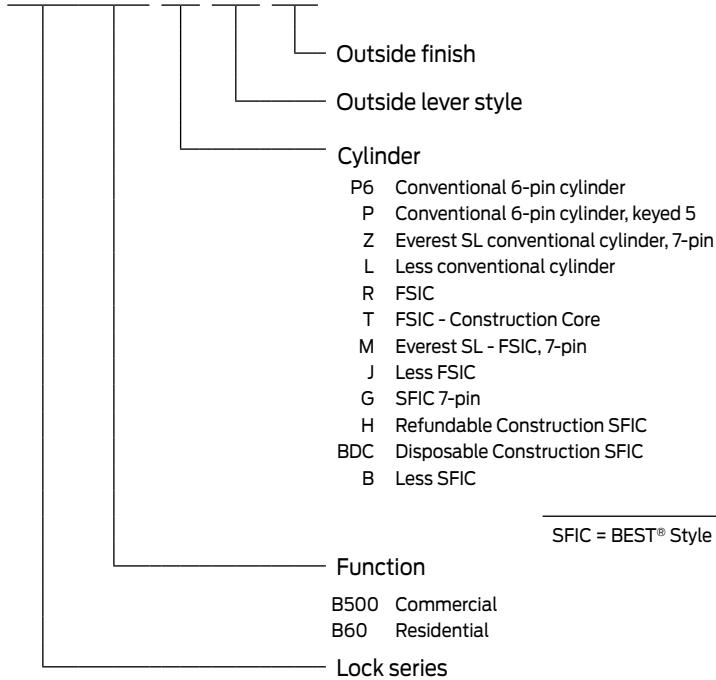
**Product identification**
**CS210-B500 . P6 . SAT . 626**

**Finish codes and descriptions**

BHMA code		Description
605	(US 3)	Bright Brass
609	(US 5)	Antique Brass
619	(US 15)	Satin Nickel
622	(US 19)	Matte Black
625	(US 26)	Bright Chrome
626	(US 26D)	Satin Chrome
643e	(US 11)	Aged Bronze

**Standard features**

Certification	ANSI/BHMA Certified A156.12-2013, Grade 2, UL listed for 3-hour fire door With SFIC interchangeable core cylinders: Grade 3 Security
Deadbolt	1 x 2-1/4", dual option faceplate, (square corner standard, round corner included in package), 1" housing diameter, 1" throw
Latch	1" x 2-1/4" dual option faceplate (square corner standard, round corner included in package). 1" edge bore required
Strikes	1-1/8" x 2-3/4", Square corner (deadbolt) and 1-5/8" x 2-1/4", Square corner, full lip, no box, 1-5/8" x 2-1/4" (Deadlatch)
Backset	Adjustable backset, fits 2-3/8" or 2-3/4"
Cylinder(s)	6-pin, solid brass, keyed 6-pin, S123 keyway, keyed different (KD)
Door range	1-3/4" to 2" standard (1-3/8" available, must be specified)
Keys	Nickel silver cut keys, 6-pin, S123 section
Center to Center	Fits 4" or 5-1/2" (factory default) center to center door preps

605	609	619	622	625	626	643E
US3	US5	US15	US19	US26	US26D	US11

## CS210 INTERCONNECT SERIES

Outside Inside

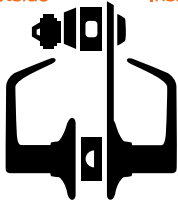

### Mechanical interconnect functions

#### CS210: Entrance, single locking

- Deadbolt operated by key from outside or by turn unit from inside
- Bolt automatically deadlocks when fully thrown
- Latch retracted by lever from either side
- Turning inside lever retracts deadbolt and latch simultaneously for immediate exit



### Finish codes and descriptions

605	609	619	622	625	626	643e
Bright Brass (US3)	Antique Brass (US5)	Satin Nickel (US15)	Matte Black (US19)	Bright Chrome (US26)	Satin Chrome (US26D)	Aged Bronze (US11)

### INTERCONNECT LEVER DESIGNS

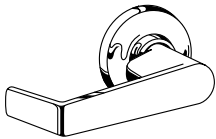

Saturn (SAT)

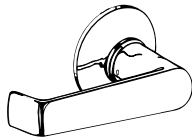

Elan (ELA)



Jupiter (JUP)

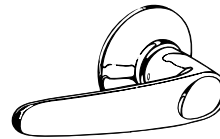

Jazz (JAZ)



Neptune (NEP)

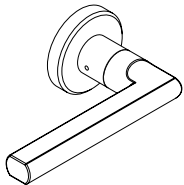

Latitude (LAT)



Broadway (BRW)

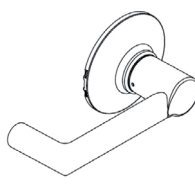

Boardwalk (BRK)

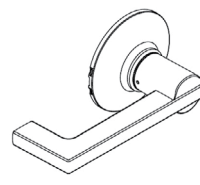

Longitude (LON)

Note: Handing must be specified for split finishes and/or designs. Right Hand is standard.

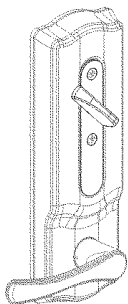

Camelot (CAM)

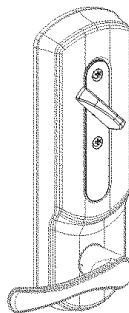

Plymouth (PLY)





605	609	619	622	625	626	643E
US3	US5	US15	US19	US26	US26D	US11

CS210 INTERCONNECT SERIES

1. SELECT LOCK MODEL		
Description	Specify	Price (ea.)
Entrance with commercial spin ring	CS210-B500	\$614.00
Entrance with residential spin ring	CS210-B60	\$614.00

2. SELECT INTERIOR DESIGN STYLE		
Description	Specify	Price adjustment
Camelot	CAM	No charge
Plymouth	PLY	No charge

3. SELECT LEVER STYLE		
Description	Specify	Price adjustment
See previous page for Lever Design Options	-	No charge

4. SELECT KEY CYLINDER OPTION		
Description	Specify	Price adjustment
Keyed different - Standard	KD	No charge
Keyed alike	KA	No charge

5. SELECT FINISH		
Description	Specify	Price adjustment
Bright Brass	605	\$12.00
Antique Brass	609	\$12.00
Satin Nickel	619	\$12.00
Matte Black	622	\$12.00
Bright Chrome	625	\$12.00
Satin Chrome	626	No charge
Aged Bronze	643e/716	\$12.00

LOCKS

EXIT DEVICES

DOOR CLOSERS

ARCHITECTURAL HARDWARE

OVERHEAD STOPS & HOLDERS

HOW TO ORDER

## L SERIES ■ OVERVIEW

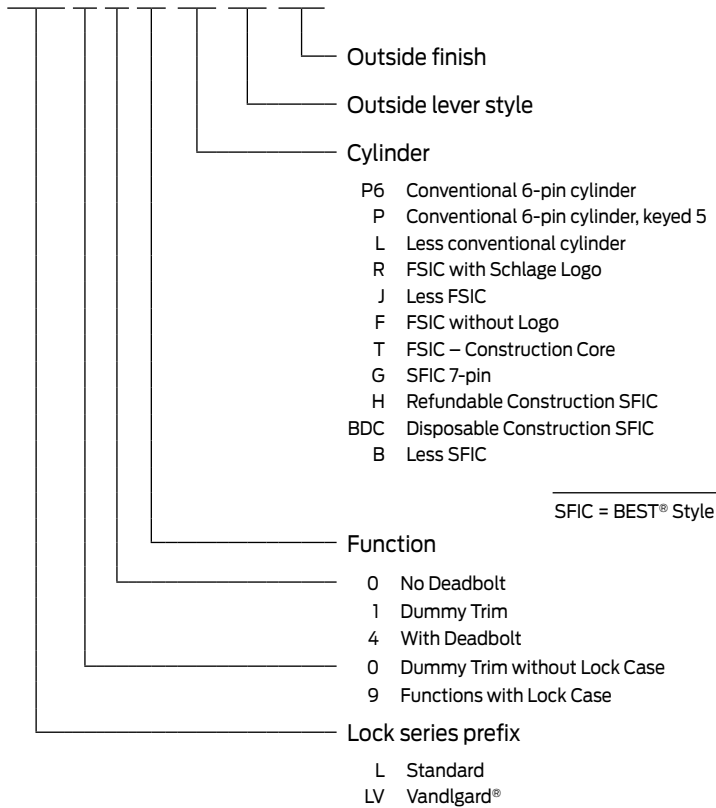
**Product identification**
**L/LV 9 4 53 . P6 . 06 . 626**

**Finish codes and descriptions**

BHMA code		Description
619	(US 15)	Satin Nickel
622	(US 19)	Matte Black
625	(US 26)	Bright Chrome
626	(US 26D)	Satin Chrome
643e	(US 11)	Aged Bronze

**Standard features**

Certification	L/LV9000: ANSI/BHMA Certified A156.13-2017, Series 1000, Grade 1 Operational, Grade 1 Security, UL Listed for 3-hour fire door (except L9076 and L9077). With FSIC Interchangeable Core Cylinders: Grade 1 Operational, Grade 2 Security. With SFIC Interchangeable Core Cylinders: Grade 1 Operational, Grade 3 Security. L400: ANSI/BHMA Certified A156.36-2010, Grade 1, UL Listed for 3-hour fire door. L909X/L949X: UL 294 Access Control Performance Levels: Destructive Attack, Level 1; Line Security, Level 1; Standby Power, Level 1; Endurance, Level IV (with DM, or LX, Endurance, Level I).
Case size	L/LV9000: 4-7/16" x 6-1/16" x 1"; L400: 4-7/16" x 3-5/8" x 1"
Armor front	L/LV9000: 1-1/4" x 8"; L400: 1-1/4" x 5-9/16"
Deadbolt	1" Throw stainless steel
Latch bolt	3/4" Throw stainless steel with anti-friction tongue
Strike	L/LV9000: 1-1/4" x 4-7/8" Square corner, 1-3/16" lip, box; L400: 1-1/8" x 3-5/8" square corner, box
Backset	2-3/4"
Cylinder	6-Pin solid brass, keyed 6-pin, S123 keyway, keyed different (KD)
Door range	1-3/4"
Keys	Two nickel silver cut keys per lock, 6-pin, S123 section

**Mechanical lock functions**

Legend

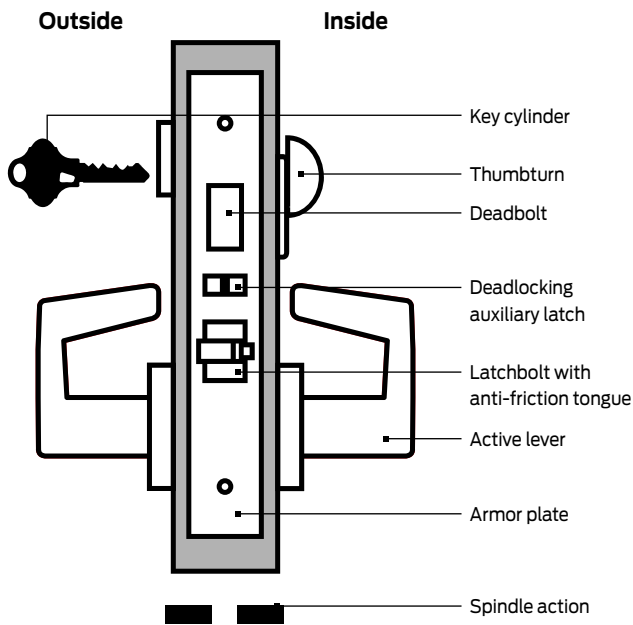

Key

- Emergency thumbturn
- Coin turn
- Cylinder thumbturn
- Fixed lever
- Knob (when lever option is not available)
- Solid spindle – connected lever movement
- Two-piece spindle – independent lever movement
- Chevron style lock status indicator
- 180-degree lock status indicator option available
- Hospital latch trim available
- High-security ligature resistant trim available
- Ligature-resistant lever trim available
- Ligature-resistant knob trim available

**Wired electrified lock functions**

Legend

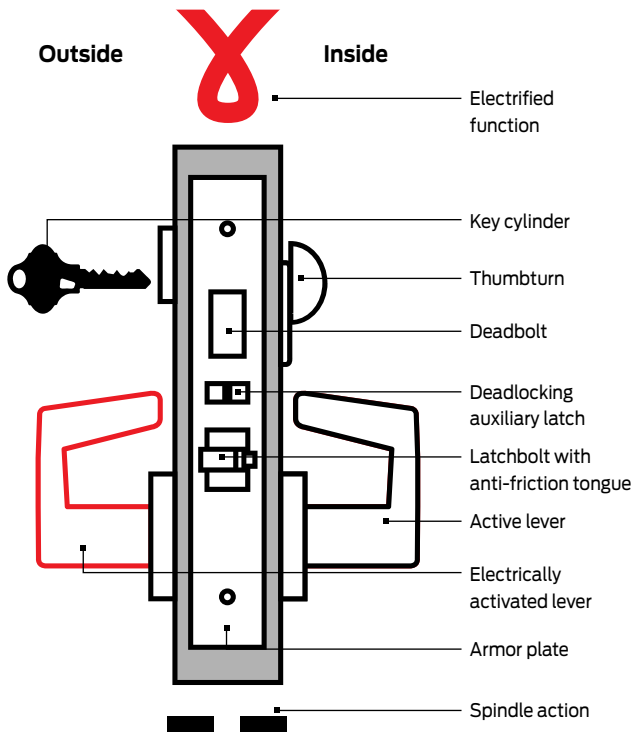

Key

- Fixed lever
- Solid spindle – connected lever movement
- Two-piece spindle – independent lever movement
- Hospital latch trim available
- High-security ligature resistant trim available
- Ligature-resistant lever trim available
- Ligature-resistant knob trim available

**LV (Vandlgard® function)** allows exterior lever to rotate freely down, while remaining securely locked.

Additional functions as well as Mortise Deadbolts are available; please consult your Allegion representative for details.

ANSI/BHMA Certified A156.13-2017, Series 1000, Grade 1 Operational, Grade 1 Security, UL Listed for 3-hour fire door (except L9076 and L9077).

**NON-KEYED**

SCHLAGE ANSI

**L9010**

**Passage latch**

F01

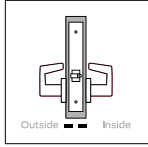

- Levers (or knobs) only—both sides; latchbolt only
- Latchbolt retracted by lever (or knob) from either side at all times
- Inside lever always free for immediate egress

**L/LV9040**

**Bath/bedroom privacy lock**

F22

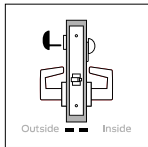

- Emergency thumbturn access outside; thumbturn inside; latchbolt only
- Latchbolt retracted by lever (or knob) from either side
- Outside lever is made inoperative by rotating inside thumbturn; Vandlgard® option allows outside lever to rotate freely down while locked
- To unlock from outside, remove access hole cover, insert emergency thumbturn (furnished) and rotate
- Rotating inside thumbturn unlocks outside lever; turning inside lever retracts latchbolt and unlocks outside lever; closing door also unlocks preventing lock-out
- Inside lever always free for immediate egress

Note: Hospital latch trim not available with Vandlgard option.

**L/LV9044**

**Privacy with coin turn outside**

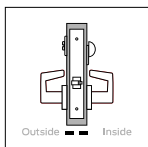

- Coin turn outside; thumbturn inside; latchbolt only
- Latchbolt retracted by lever (or knob) from either side
- Outside lever is made inoperative by rotating outside coin turn or inside thumbturn; Vandlgard® option allows outside lever to rotate freely down while locked
- Rotating outside coin turn unlocks outside lever
- Rotating inside thumbturn unlocks outside lever; turning inside lever retracts latchbolt and unlocks outside lever; closing door also unlocks preventing lock-out
- Inside lever always free for immediate egress

Note: Ligature-resistant trims not available with Vandlgard option.

**NON-KEYED**

SCHLAGE ANSI

**L/LV9440**

**Privacy with deadbolt**

F19

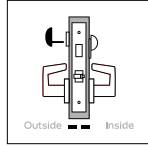

- Emergency thumbturn access outside; thumbturn inside; deadbolt and latchbolt
- Latchbolt retracted by lever (or knob) from either side
- Outside lever is made inoperative when deadbolt is thrown by rotating inside thumbturn; Vandlgard® option allows outside lever to rotate freely down while locked
- To unlock from outside, remove access hole cover, insert emergency thumbturn (furnished) and rotate
- Rotating inside thumbturn unlocks outside lever; turning inside lever retracts both deadbolt and latchbolt and unlocks outside lever
- Inside lever always free for immediate egress

**L/LV9444**

**Privacy with deadbolt and coin turn outside**

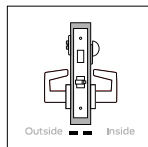

- Coin turn outside; thumbturn inside; deadbolt and latchbolt
- Latchbolt retracted by lever (or knob) from either side
- Outside lever is made inoperative when deadbolt is thrown by rotating inside thumbturn or outside coin turn; Vandlgard® option allows outside lever to rotate freely down while locked
- Rotating outside coin turn retracts deadbolt and unlocks outside lever
- Rotating inside thumbturn unlocks outside lever; turning inside lever retracts both deadbolt and latchbolt and unlocks outside lever
- Inside lever always free for immediate egress

Note: Ligature-resistant trims not available with Vandlgard option.

**NON-KEYED DUMMY**

SCHLAGE ANSI

**L0170**

**Half dummy trim**

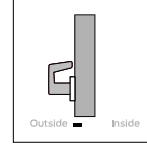

- Lever (or knob) only—one side; no armor front or mortise case
- Lever always fixed

Note: Available in rose, L or N escutcheon trim. Do not use on hollow core wood doors. All metal door applications require reinforcement.

Ordering: Specify door handing. Additionally, when ordering with escutcheon trim, an inside escutcheon with through bolts will be provided.

**L0172**

**Full dummy trim**

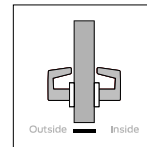

- Levers (or knobs) only—both sides; no armor front or mortise case
- Both levers always fixed

Note: Available in rose, L or N escutcheon trim. Do not use on hollow core wood doors. All metal door applications require reinforcement.

Ordering: In a double-door application where dummy is used as the strike, order 10-091 armored front strike separately.

**L9175**

**Half dummy trim with lock case**

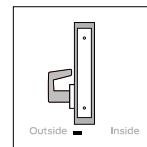

- Lever (or knob) only—one side; blank armor front without latchbolt
- Lever always fixed

Note: Includes blank armor front and lock case.

Door handing must be specified. May be ordered with optional XL11-743 armor front with cutout to receive deadbolt.

See page 67 for more information on trim and Vandlgard® options.

Additional functions as well as Mortise Deadbolts are available; please consult your Allegion representative for details.

**NON-KEYED DUMMY**

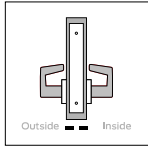
 SCHLAGE ANSI
**L9176**

**Full dummy trim with lock case**

- Levers (or knobs) only-both sides; blank armor front without latchbolt
- Both levers always fixed

Note: Includes blank armor front and lock case.

May be ordered with optional XL11-743 armor front with cutout to receive deadbolt.

Ordering: In a double-door application where dummy is used as the strike, order 10-091 armored front strike separately.

**SINGLE CYLINDER NON-DEADBOLT**

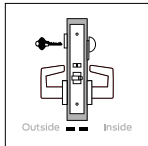
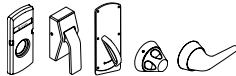
 SCHLAGE ANSI
**L/LV9050**

**Entrance/office lock**

- Key cylinder outside; thumbturn inside; latchbolt and deadlocking auxiliary latch
- Latchbolt retracted by lever (or knob) from either side
- Outside lever is made inoperative by key outside or by turning inside thumbturn; Vandlgard® option allows both levers to rotate freely down while locked
- Key outside unlocks outside lever and retracts latchbolt
- Rotating inside thumbturn unlocks outside lever; turning inside lever retracts latchbolt but does not unlock
- Inside lever always free for immediate egress

Caution: Egress without fully rotating the thumbturn to vertical position can result in lock-out situations.

Note: Hospital latch and ligature-resistant trims not available with Vandlgard option.

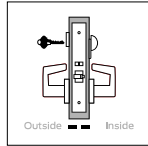
**SINGLE CYLINDER NON-DEADBOLT**

 SCHLAGE ANSI
**L/LV9056 with XL13-439**

**Entrance/office lock with automatic unlocking**

- Key cylinder outside; thumbturn inside; latchbolt and deadlocking auxiliary latch
- Latchbolt retracted by lever (or knob) from either side
- Outside lever is made inoperative by key outside or by turning inside thumbturn; Vandlgard® option allows outside lever to rotate freely down while locked
- Key outside unlocks outside lever and retracts latchbolt
- XL13-439 option allows key to retract latchbolt overriding thumbturn if being held in locked position
- Rotating inside thumbturn unlocks outside lever; turning inside lever retracts latchbolt and unlocks outside lever; closing door also unlocks preventing lock-out
- Inside lever always free for immediate egress

Note: Ligature-resistant trims not available with Vandlgard option.

To order with key override, specify function and note XL13-439 as a special option.

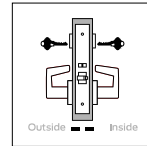
**DOUBLE CYLINDER NON-DEADBOLT**

 SCHLAGE ANSI
**L/LV9060**

**Apartment entrance lock**

- Key cylinder both sides; latchbolt and deadlocking auxiliary latch
- Latchbolt retracted by lever (or knob) from either side
- Outside lever is made inoperative by key inside; Vandlgard® option allows outside lever to rotate freely down while locked
- Key outside retracts latchbolt but cannot lock or unlock outside lever
- Rotating inside lever retracts latchbolt; key inside retracts latchbolt and unlocks outside lever
- Inside lever always free for immediate egress

Note: Outside lever remains inoperative until unlocked by key inside.

Note: Hospital latch and ligature-resistant trims not available with Vandlgard option.

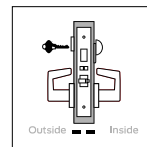
**SINGLE CYLINDER DEADBOLT**

 SCHLAGE ANSI
**L/LV9453**

**Entrance/office lock with deadbolt**

- Key cylinder outside; thumbturn inside; deadbolt, latchbolt and deadlocking auxiliary latch
- Latchbolt retracted by lever (or knob) from either side
- Outside lever is made inoperative when deadbolt is thrown by key outside; rotating thumbturn 20° locks outside lever only; rotating thumbturn 90° also throws deadbolt; Vandlgard® option allows outside lever to rotate freely down while locked
- Key outside retracts deadbolt and latchbolt, however, outside lever remains locked
- Rotating inside lever retracts deadbolt and latchbolt; outside lever unlocked when thumbturn is returned to vertical position
- Inside lever always free for immediate egress

Caution: Egress without fully rotating the thumbturn to vertical position can result in lock-out situations.

Note: Hospital latch and ligature-resistant trims not available with Vandlgard option.

See page 67 for more information on trim and Vandlgard® options.

Additional functions as well as Mortise Deadbolts are available; please consult your Allegion representative for details.

**SINGLE CYLINDER DEADBOLT**

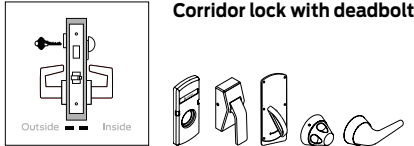
 SCHLAGE ANSI
**L/LV9456** **F13**  
**L/LV9456 with XL13-439**

**Corridor lock with deadbolt**

- Key cylinder outside; thumbturn inside; deadbolt and latchbolt
- Latchbolt retracted by lever (or knob) from either side
- Outside lever is made inoperative when deadbolt is thrown by key outside or by inside thumbturn; Vandlgard® option allows outside lever to rotate freely down while locked
- Key outside retracts deadbolt and unlocks outside lever
- XL13-439 option allows key to retract deadbolt overriding thumbturn if being held in locked position
- Rotating inside lever retracts both deadbolt and latchbolt and unlocks outside lever
- Inside lever always free for immediate egress

Note: Hospital latch and ligature-resistant trims not available with Vandlgard option.

To order with key override, specify function and note XL13-439 as a special option.

**L9465**

**Closet/storeroom lock**

- Key cylinder outside with lever (or knob); lever only-inside; deadbolt and latchbolt
- Latchbolt retracted by lever (or knob) from either side at all times
- Deadbolt thrown or retracted by key outside

Caution: Deadbolt locks with outside key retraction only can result in situations where occupants can be locked in.

Note: Hospital latch and ligature-resistant trims not available with Vandlgard option.

**SINGLE CYLINDER DEADBOLT**

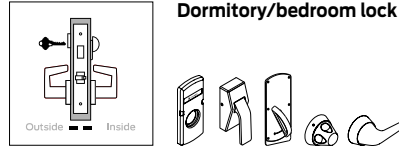
 SCHLAGE ANSI
**L9473** **F21**

**Dormitory/bedroom lock**

- Key cylinder outside; thumbturn inside; deadbolt and latchbolt
- Latchbolt retracted by lever (or knob) from either side at all times
- Deadbolt thrown or retracted by key outside or by inside thumbturn

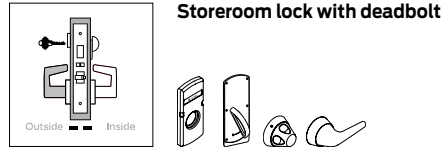
Note: Hospital latch and ligature-resistant trims not available with Vandlgard option.

**L/LV9480**  
**L/LV9480 with XL13-439**

**Storeroom lock with deadbolt**

- Key cylinder outside; thumbturn inside; deadbolt, latchbolt and deadlocking auxiliary latch
- Outside lever (or knob) always fixed; latchbolt retracted by inside lever; Vandlgard® option allows outside lever to rotate freely down while locked
- Deadbolt thrown or retracted by key outside or by inside thumbturn
- Key outside retracts deadbolt and latchbolt, however, outside lever remains locked
- XL13-439 option allows key to retract deadbolt and latchbolt overriding thumbturn if being held in locked position
- Rotating inside lever retracts both deadbolt and latchbolt
- Inside lever always free for immediate egress

Note: Ligature-resistant trims not available with Vandlgard option.

To order with key override, specify function and note XL13-439 as a special option.

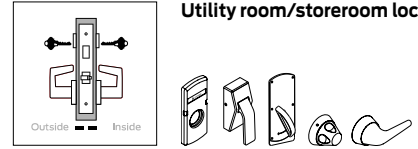
**DOUBLE CYLINDER DEADBOLT**

 SCHLAGE ANSI
**L9466** **F14**

**Utility room/storeroom lock**

- Key cylinder both sides; deadbolt and latchbolt
- Latchbolt retracted by lever (or knob) from either side
- Deadbolt thrown or retracted by key from either side

Caution: Double cylinder locks on any door, in any structure which is used for egress are a life safety hazard in times of emergency and their use is not recommended. Installation should be in accordance with existing codes only.

Note: Hospital latch and ligature-resistant trims not available with Vandlgard option.

See page 67 for more information on trim and Vandlgard® options.

Additional functions as well as Mortise Deadbolts are available; please consult your Allegion representative for details.

RESIDENTIAL ELECTRONIC | RESIDENTIAL MECHANICAL | COMMERCIAL WIRELESS ELECTRONIC | COMMERCIAL MECHANICAL/ELECTRIFIED

### L909x EL/EU electrified locks

All locks feature automatic detection and operation with 12 or 24V DC, and a case-mounted switch that allows customer selection of EL (fail safe - power failure allows either knob/lever to retract latchbolt and/or deadbolt) or EU (fail secure - power failure locks outside knob/lever or both knobs/levers). Please specify lock function as EL or EU for default switch position.

Locks also come standard with Allegion Connect Molex connector with 3" lead and CON-6W. Allegion Connect is a Molex connector system that allows rapid installation of locks when used with Allegion Connect Harnesses (see Schlage Commercial price book) and Allegion Connect Hinges (see Ives price book). Indicators are not allowed on electrified locks. For more information speak with your sales representative. The Molex connector can also be cut off so that the lock can be installed with traditional splicing. UL 294 Access Control Performance Levels: Destructive Attack, Level 1; Line Security, Level 1; Standby Power, Level 1; Endurance, Level IV (with DM, or LX, Endurance, Level I).

Available options for electrified functions:

- Request-to-Exit (RX)
- Latch bolt monitor (LX)
- Door position sensor (DPS) (non-deadbolt models only)
- Deadbolt monitor (DM) (standard on electrified deadbolt models)
- Vandlgard versions only available with RX option

#### NON-KEYED ELECTRIFIED

SCHLAGE

ANSI

**L/LV9090EL/EU**

-

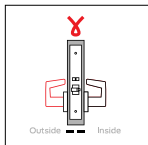

**Electrically locking/unlocking outside lever, no cylinder**



- Levers (or knobs) only both sides; latchbolt and deadlocking auxiliary latch
- Powered state: outside lever (or knob) continuously locked (EL mode) or unlocked (EU mode); Vandlgard® option allows outside lever to rotate freely down while locked
- When power is removed (or power fails): in EL mode either lever will retract latchbolt; in EU mode outside lever is locked
- Inside lever always free for immediate egress

Note: Auto detects 12 or 24V DC.

Note: Ligature-resistant trims not available with Vandlgard option.

Ordering: Case-mounted switch allows field selectable EL/EU setting however, when ordering, please specify EL or EU.

#### NON-KEYED ELECTRIFIED

SCHLAGE

ANSI

**L/LV9091EL/EU**

-

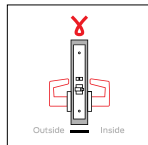

**Electrically locking/unlocking both levers, no cylinder**



- Levers (or knobs) only both sides; latchbolt and deadlocking auxiliary latch
- Powered state: both levers (or knobs) continuously locked (EL mode) or unlocked (EU mode); Vandlgard® option allows both levers to rotate freely down while locked
- When power is removed (or power fails): in EL mode either lever will retract latchbolt; in EU mode both levers are locked

Note: Auto detects 12 or 24V DC.

Note: Ligature-resistant trims not available with Vandlgard option.

Ordering: Case-mounted switch allows field selectable EL/EU setting however, when ordering, please specify EL or EU.

#### KEYED NON-DEADBOLT ELECTRIFIED

SCHLAGE

ANSI

**L/LV9092EL/EU**

-

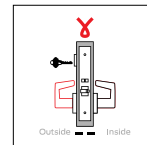

**Electrically locking/unlocking outside lever, outside cylinder**

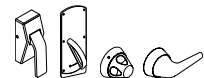

- Key cylinder outside with lever (or knob); lever only-inside; latchbolt and deadlocking auxiliary latch
- Powered state: outside lever (or knob) continuously locked (EL mode) or unlocked (EU mode); Vandlgard® option allows outside lever to rotate freely down while locked
- Key outside retracts latchbolt but cannot change the normal locked or unlocked state of outside lever
- When power is removed (or power fails): in EL mode either lever will retract latchbolt; in EU mode outside lever is locked
- Inside lever always free for immediate egress

Note: Auto detects 12 or 24V DC.

Note: Hospital latch and ligature-resistant trims not available with Vandlgard option.

Ordering: Case-mounted switch allows field selectable EL/EU setting however, when ordering, please specify EL or EU.

See page 67 for more information on trim and Vandlgard® options.

Additional functions as well as Mortise Deadbolts are available; please consult your Allegion representative for details.

**KEYED NON-DEADBOLT ELECTRIFIED**

SCHLAGE ANSI

L/LV9093EL/EU -

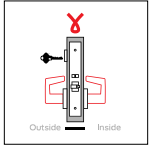

**Electrically locking/unlocking both levers, outside cylinder**



- Key cylinder outside with lever (or knob); lever only-inside; latchbolt and deadlocking auxiliary latch
- Powered state: both levers (or knobs) continuously locked (EL mode) or unlocked (EU mode); Vandlgard® option allows both levers to rotate freely down while locked
- Key outside retracts latchbolt but cannot change the normal locked or unlocked state of either lever
- When power is removed (or power fails): in EL mode either lever will retract latchbolt; in EU mode both levers are locked

Note: Auto detects 12 or 24V DC.

Note: Ligature-resistant trims not available with Vandlgard option.

Ordering: Case-mounted switch allows field selectable EL/EU setting however, when ordering, please specify EL or EU.

L/LV9095EL/EU -

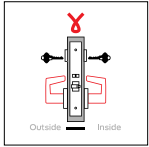

**Electrically locking/unlocking both levers, double cylinder**



- Key cylinder both sides; latchbolt and deadlocking auxiliary latch
- Powered state: both levers (or knobs) continuously locked (EL mode) or unlocked (EU mode); Vandlgard® option allows both levers to rotate freely down while locked
- Key on either side retracts latchbolt but cannot change the normal locked or unlocked state of either lever
- When power is removed (or power fails): in EL mode either lever will retract latchbolt; in EU mode both levers are locked

Note: Auto detects 12 or 24V DC.

Note: Hospital latch and ligature-resistant trims not available with Vandlgard option.

Ordering: Case-mounted switch allows field selectable EL/EU setting however, when ordering, please specify EL or EU.

**DEADBOLT ELECTRIFIED**

SCHLAGE ANSI

L/LV9492EL/EU -  
L/LV9492EL/EU with XL13-439

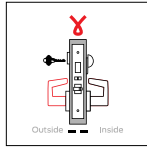

**Electrically locking/unlocking outside lever, outside cylinder, inside thumbturn with deadbolt**



- Key cylinder outside; thumbturn inside; deadbolt, latchbolt and deadlocking auxiliary latch
- Powered state: outside lever (or knob) continuously locked (EL mode) or unlocked (EU mode); Vandlgard® option allows outside lever to rotate freely down while locked
- Deadbolt thrown or retracted by key outside or by inside thumbturn
- XL13-439 option allows key to retract deadbolt and latchbolt overriding thumbturn if being held in locked position
- When power is removed (or power fails): in EL mode either lever will retract latchbolt; in EU mode outside lever is locked; deadbolt projection is independent of electrically locked or unlocked state of outside lever
- Rotating inside lever retracts both deadbolt and latchbolt
- Inside lever always free for immediate egress

Note: Auto detects 12 or 24V DC; supplied deadbolt monitor allows option to prevent ingress with card use when deadbolt is thrown.

Note: Ligature-resistant trims not available with Vandlgard option.

Ordering: Case-mounted switch allows field selectable EL/EU setting however, when ordering, please specify EL or EU.

L/LV9493EL/EU -  
L/LV9493EL/EU with XL13-439

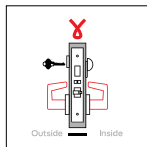

**Electrically locking/unlocking both levers, outside cylinder, inside thumbturn with deadbolt**



- Key cylinder outside; thumbturn inside; deadbolt, latchbolt and deadlocking auxiliary latch
- Powered state: both levers (or knobs) continuously locked (EL mode) or unlocked (EU mode); Vandlgard® option allows both levers to rotate freely down while locked
- Deadbolt thrown or retracted by key outside or by inside thumbturn
- XL13-439 option allows key to retract deadbolt overriding thumbturn if being held in locked position
- When power is removed (or power fails): in EL mode either lever will retract latchbolt; in EU mode both levers are locked; deadbolt projection is independent of electrically locked or unlocked state of either lever
- When unlocked, rotating inside lever retracts both deadbolt and latchbolt

Note: Auto detects 12 or 24V DC; supplied deadbolt monitor allows option to prevent ingress with card use when deadbolt is thrown.

Note: Ligature-resistant trims not available with Vandlgard option.

Ordering: Case-mounted switch allows field selectable EL/EU setting however, when ordering, please specify EL or EU.

**DEADBOLT ELECTRIFIED**

SCHLAGE ANSI

L/LV9494EL/EU -

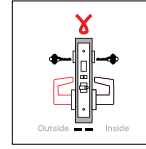

**Electrically locking/unlocking outside lever, double cylinder with deadbolt**



- Key cylinder both sides; deadbolt, latchbolt and deadlocking auxiliary latch
- Powered state: outside lever (or knob) continuously locked (EL mode) or unlocked (EU mode); Vandlgard® option allows outside lever to rotate freely down while locked
- Deadbolt thrown or retracted by key from either side
- When power is removed (or power fails): in EL mode either lever will retract latchbolt; in EU mode outside lever is locked; deadbolt projection is independent of electrically locked or unlocked state of outside lever
- Rotating inside lever retracts both deadbolt and latchbolt
- Inside lever always free for immediate egress

Note: Auto detects 12 or 24V DC; supplied deadbolt monitor allows option to prevent ingress with card use when deadbolt is thrown.

Note: Ligature-resistant trims not available with Vandlgard option.

Ordering: Case-mounted switch allows field selectable EL/EU setting however, when ordering, please specify EL or EU.

L/LV9495EL/EU -

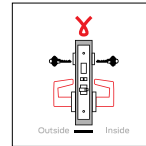

**Electrically locking/unlocking both levers, double cylinder with deadbolt**



- Key cylinder both sides; deadbolt, latchbolt and deadlocking auxiliary latch
- Powered state: both levers (or knobs) continuously locked (EL mode) or unlocked (EU mode); Vandlgard® option allows both levers to rotate freely down while locked
- Deadbolt thrown or retracted by key from either side
- When power is removed (or power fails): in EL mode either lever will retract latchbolt; in EU mode both levers are locked; deadbolt projection is independent of electrically locked or unlocked state of either lever
- When unlocked, rotating inside lever retracts both deadbolt and latchbolt

Note: Auto detects 12 or 24V DC; supplied deadbolt monitor allows option to prevent ingress with card use when deadbolt is thrown.

Note: Ligature-resistant trims not available with Vandlgard option.

Ordering: Case-mounted switch allows field selectable EL/EU setting however, when ordering, please specify EL or EU.

See page 67 for more information on trim and Vandlgard® options.

Additional functions as well as Mortise Deadbolts are available; please consult your Allegion representative for details.



**STANDARD LEVER DESIGNS (CAST OR FORGED)**

Note: A wide variety of additional lever designs are available; consult your Allegion representative for details.

**06 (RHODES)**

Tactile option: 806 (milled)

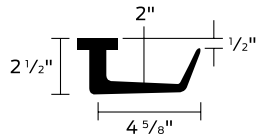
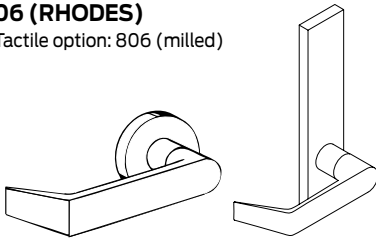
**07 (ATHENS)**

Tactile option: 807 (milled)

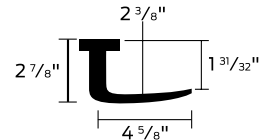
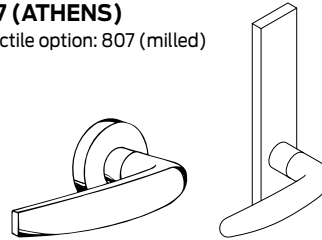

Available roses: A (shown), B, C

Available escutcheons: L (shown), N

Available roses: A (shown), B, C

Available escutcheons: L (shown), N

**17 (SPARTA)**

Tactile option: 817 (milled)

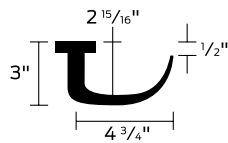
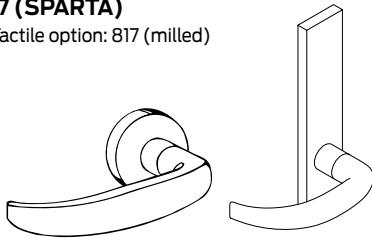
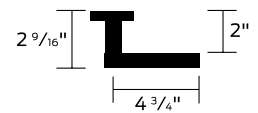
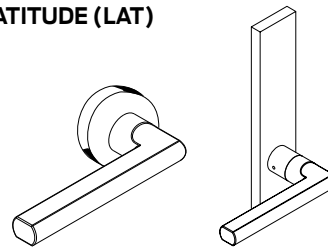

**LATITUDE (LAT)**

Available roses: A (shown), B, C

Available escutcheons: L (shown), N

Available roses: A (shown), B, C

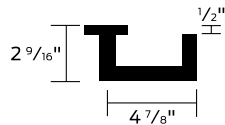
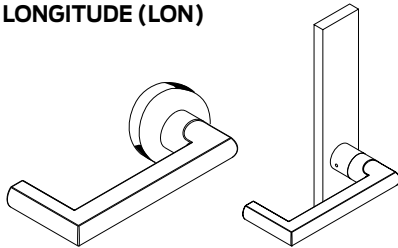
Available escutcheons: L (shown), N

**LONGITUDE (LON)**

Available roses: A (shown), B, C

Available escutcheons: L (shown), N

**M COLLECTION LEVER DESIGNS (CAST OR FORGED)**

Note: A wide variety of additional lever designs are available; consult your Allegion representative for details.

**M52 (BROADWAY)**

Tactile option: 852 (knurled)

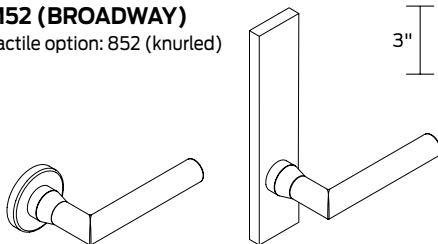
**M81 (BOARDWALK)**

Tactile option: 881 (knurled)

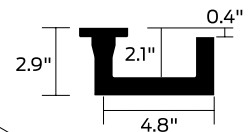
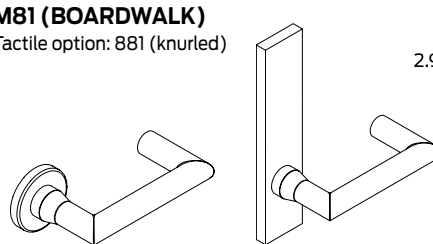

Available roses: A (shown), B, C

Available escutcheons: L (shown), N

Available roses: A (shown), B, C

Available escutcheons: L (shown), N

**WROUGHT ROSE DESIGNS**

**A**  
2-1/8" (54 mm) diameter

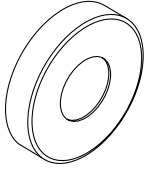

**B**  
2-9/16" (65mm) diameter

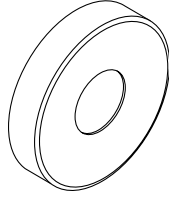

**C**  
2-5/8" (66mm) diameter  
Not available 612 or 613 finish

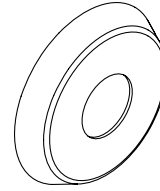

**L (CAST/FORGED) AND N (WROUGHT) ESCUTCHEON TRIM DESIGNS**



7<sup>15</sup>/<sub>16</sub>" x 1<sup>3</sup>/<sub>4</sub>" x 7/<sub>16</sub>"  
(202mm x 44mm x 11mm)

Non-Vandlgard functions:  
available on 1<sup>3</sup>/<sub>8</sub>" – 2<sup>1</sup>/<sub>2</sub>" doors  
Vandlgard functions:  
available on 1<sup>3</sup>/<sub>4</sub>" – 2<sup>1</sup>/<sub>2</sub>" doors

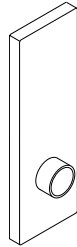

7<sup>7</sup>/<sub>8</sub>" x 2<sup>1</sup>/<sub>2</sub>" x 7/<sub>16</sub>"  
(200mm x 64mm x 11mm)

Available on 1<sup>3</sup>/<sub>4</sub>" – 2<sup>1</sup>/<sub>4</sub>"  
doors for non-Vandlgard  
and Vandlgard functions

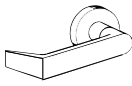
COMPLETE LOCKS			LEVER STYLES		
 ROSE TRIM  Split finishes and designs will be priced at the highest list price of the design and/or finish.  Keyed function pricing based on P6 cylinder with open S123 keyway. See page 83 for additional cylinder and keyway options.			06	06	M52 M81
			07	07	
			17	17	
			LAT <sup>Ⓜ</sup>	LAT <sup>Ⓜ</sup>	
			LON <sup>Ⓜ</sup>	LON <sup>Ⓜ</sup>	
			FINISHES		
			626	619, 622, 625, 643e	619, 622, 625, 626, 643e
SERIES + FUNCTION	CYL	DESCRIPTION	ROSE TRIM		
NON-KEYED FUNCTIONS			ROSE TRIM		
L9010		Passage latch	\$1,034.00	\$1,046.00	\$1,064.00
L9040		Bath/bedroom privacy lock	\$1,191.00	\$1,203.00	\$1,221.00
LV9040		Vandlgard bath/bedroom privacy lock	\$1,338.00	\$1,350.00	\$1,368.00
L9044		Privacy with coin turn outside	\$1,131.00	\$1,143.00	\$1,161.00
LV9044		Vandlgard privacy with coin turn outside	\$1,278.00	\$1,290.00	\$1,308.00
L9440		Privacy with deadbolt	\$1,369.00	\$1,381.00	\$1,399.00
LV9440		Vandlgard privacy with deadbolt	\$1,516.00	\$1,528.00	\$1,546.00
L9444		Privacy with deadbolt and coin turn outside	\$1,306.00	\$1,318.00	\$1,336.00
LV9444		Vandlgard privacy with deadbolt and coin turn outside	\$1,453.00	\$1,465.00	\$1,483.00
L9090EL		Electrically locking outside lever, no cylinder	\$1,714.00	\$1,726.00	\$1,744.00
LV9090EL		Vandlgard electrically locking outside lever, no cylinder	\$1,861.00	\$1,873.00	\$1,891.00
L9090EU		Electrically unlocking outside lever, no cylinder	\$1,714.00	\$1,726.00	\$1,744.00
LV9090EU		Vandlgard electrically unlocking outside lever, no cylinder	\$1,861.00	\$1,873.00	\$1,891.00
L9091EL		Electrically locking both levers, no cylinder	\$1,714.00	\$1,726.00	\$1,744.00
LV9091EL		Vandlgard electrically locking both levers, no cylinder	\$1,861.00	\$1,873.00	\$1,891.00
L9091EU		Electrically unlocking both levers, no cylinder	\$1,714.00	\$1,726.00	\$1,744.00
LV9091EU		Vandlgard electrically unlocking both levers, no cylinder	\$1,861.00	\$1,873.00	\$1,891.00
NON-KEYED DUMMY FUNCTIONS			ROSE TRIM		
L0170		Half dummy trim	\$372.00	\$378.00	\$387.00
L0172		Full dummy trim	\$743.00	\$755.00	\$773.00
L9175		Half dummy trim with lock case	\$554.00	\$560.00	\$569.00
L9176		Full dummy trim with lock case	\$914.00	\$926.00	\$944.00
KEYED, SINGLE CYLINDER, NON-DEADBOLT FUNCTIONS			ROSE TRIM		
L9050	P6	Entrance/office lock	\$1,325.00	\$1,337.00	\$1,355.00
LV9050	P6	Vandlgard entrance/office lock	\$1,472.00	\$1,484.00	\$1,502.00
L9056	P6	Entrance/office lock with automatic unlocking	\$1,448.00	\$1,460.00	\$1,478.00
L9056 with XL13-439	P6	Entrance/office lock with automatic unlocking and outside key override feature (specify L9056 with XL13-439 as special option)	\$1,658.00	\$1,670.00	\$1,688.00
LV9056	P6	Vandlgard entrance/office lock with automatic unlocking	\$1,595.00	\$1,607.00	\$1,625.00
LV9056 with XL13-439	P6	Vandlgard entrance/office lock with automatic unlocking and outside key override feature (specify LV9056 with XL13-439 as special option)	\$1,805.00	\$1,817.00	\$1,835.00
L9080	P6	Storeroom lock	\$1,325.00	\$1,337.00	\$1,355.00
LV9080	P6	Vandlgard storeroom lock	\$1,472.00	\$1,484.00	\$1,502.00
L9092EL	P6	Electrically locking outside lever, outside cylinder	\$1,847.00	\$1,859.00	\$1,877.00

Ⓜ Extended lead time

Note: For the Everest 29 T and Everest D family of restricted keyways (Quad, Numbered, Reversed), add \$31.00. This does not apply to Primus families. See Terms and Conditions for more information.

619	622	625	626	643E
US15	US19	US26	US26D	US11

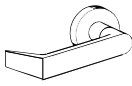
COMPLETE LOCKS			LEVER STYLES		
 <p>ROSE TRIM</p> <p>Split finishes and designs will be priced at the highest list price of the design and/or finish.</p> <p>Keyed function pricing based on P6 cylinder with open S123 keyway. See page 83 for additional cylinder and keyway options.</p>			06	06	M52 M81
			07	07	
			LAT ☒	LAT ☒	
			LON ☒	LON ☒	
			FINISHES		
			626	619, 622, 625, 643e	619, 622, 625, 626, 643e
SERIES + FUNCTION	CYL	DESCRIPTION	ROSE TRIM		
KEYED, SINGLE CYLINDER, NON-DEADBOLT FUNCTIONS			ROSE TRIM		
LV9092EL	P6	Vandlgard electrically locking outside lever, outside cylinder	\$1,994.00	\$2,006.00	\$2,024.00
L9092EU	P6	Electrically unlocking outside lever, outside cylinder	\$1,847.00	\$1,859.00	\$1,877.00
LV9092EU	P6	Vandlgard electrically unlocking outside lever, outside cylinder	\$1,994.00	\$2,006.00	\$2,024.00
L9093EL	P6	Electrically locking both levers, outside cylinder	\$1,847.00	\$1,859.00	\$1,877.00
LV9093EL	P6	Vandlgard electrically locking both levers, outside cylinder	\$1,994.00	\$2,006.00	\$2,024.00
L9093EU	P6	Electrically unlocking both levers, outside cylinder	\$1,847.00	\$1,859.00	\$1,877.00
LV9093EU	P6	Vandlgard electrically unlocking both levers, outside cylinder	\$1,994.00	\$2,006.00	\$2,024.00
KEYED, DOUBLE CYLINDER, NON-DEADBOLT FUNCTIONS			ROSE TRIM		
L9060	P6	Apartment entrance lock	\$1,457.00	\$1,469.00	\$1,487.00
LV9060	P6	Vandlgard apartment entrance lock	\$1,604.00	\$1,616.00	\$1,634.00
L9095EL	P6	Electrically locking both levers, inside and outside cylinder	\$1,981.00	\$1,993.00	\$2,011.00
LV9095EL	P6	Vandlgard electrically locking both levers, inside and outside cylinder	\$2,128.00	\$2,140.00	\$2,158.00
L9095EU	P6	Electrically unlocking both levers, inside and outside cylinder	\$1,981.00	\$1,993.00	\$2,011.00
LV9095EU	P6	Vandlgard electrically unlocking both levers, inside and outside cylinder	\$2,128.00	\$2,140.00	\$2,158.00
KEYED, SINGLE CYLINDER, DEADBOLT FUNCTIONS			ROSE TRIM		
L9453	P6	Entrance/office lock with deadbolt	\$1,369.00	\$1,381.00	\$1,399.00
LV9453	P6	Vandlgard entrance/office lock with deadbolt	\$1,516.00	\$1,528.00	\$1,546.00
L9456	P6	Corridor lock with deadbolt	\$1,369.00	\$1,381.00	\$1,399.00
L9456 with XL13-439	P6	Corridor lock with deadbolt and outside key override feature (specify L9456 with XL13-439 as special option)	\$1,579.00	\$1,591.00	\$1,609.00
LV9456	P6	Vandlgard corridor lock with deadbolt	\$1,516.00	\$1,528.00	\$1,546.00
LV9456 with XL13-439	P6	Vandlgard corridor lock with deadbolt and outside key override feature (specify LV9456 with XL13-439 as special option)	\$1,726.00	\$1,738.00	\$1,756.00
L9465	P6	Closet/storeroom lock	\$1,369.00	\$1,381.00	\$1,399.00
L9473	P6	Dormitory/bedroom lock	\$1,369.00	\$1,381.00	\$1,399.00
L9480	P6	Storeroom lock with deadbolt	\$1,500.00	\$1,512.00	\$1,530.00
L9480 with XL13-439	P6	Storeroom lock with deadbolt and outside key override feature (specify L9480 with XL13-439 as special option)	\$1,710.00	\$1,722.00	\$1,740.00
LV9480	P6	Vandlgard storeroom lock with deadbolt	\$1,647.00	\$1,659.00	\$1,677.00
LV9480 with XL13-439	P6	Vandlgard storeroom lock with deadbolt and outside key override feature (specify LV9480 with XL13-439 as special option)	\$1,857.00	\$1,869.00	\$1,887.00
L9492EL	P6	Electrically locking outside lever, outside cylinder, inside thumbturn, with deadbolt	\$2,179.00	\$2,191.00	\$2,209.00

☒ Extended lead time

Note: For the Everest 29 T and Everest D family of restricted keyways (Quad, Numbered, Reversed), add \$31.00. This does not apply to Primus families. See Terms and Conditions for more information.

RESIDENTIAL ELECTRONIC  
RESIDENTIAL MECHANICAL  
COMMERCIAL WIRELESS ELECTRONIC  
COMMERCIAL MECHANICAL/ELECTRIFIED

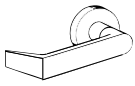
COMPLETE LOCKS			LEVER STYLES		
 <p>ROSE TRIM</p> <p>Split finishes and designs will be priced at the highest list price of the design and/or finish.</p> <p>Keyed function pricing based on P6 cylinder with open S123 keyway. See page 83 for additional cylinder and keyway options.</p>			06	06	M52 M81
			07	07	
			17	17	
			LAT <sup>Ⓜ</sup>	LAT <sup>Ⓜ</sup>	
			LON <sup>Ⓜ</sup>	LON <sup>Ⓜ</sup>	
			FINISHES		
			626	619, 622, 625, 643e	619, 622, 625, 626, 643e
SERIES + FUNCTION	CYL	DESCRIPTION	ROSE TRIM		
KEYED, SINGLE CYLINDER, DEADBOLT FUNCTIONS			ROSE TRIM		
L9492EL with XL13-439	P6	Electrically locking outside lever, outside cylinder, inside thumbturn with deadbolt and outside key override feature (specify L9492EL with XL13-439 as special option)	\$2,389.00	\$2,401.00	\$2,419.00
LV9492EL	P6	Vandlgard electrically locking outside lever, outside cylinder, inside thumbturn, with deadbolt	\$2,326.00	\$2,338.00	\$2,356.00
LV9492EL with XL13-439	P6	Vandlgard electrically locking outside lever, outside cylinder, inside thumbturn with deadbolt and outside key override feature (specify LV9492EL with XL13-439 as special option)	\$2,536.00	\$2,548.00	\$2,566.00
L9492EU	P6	Electrically unlocking outside lever, outside cylinder, inside thumbturn, with deadbolt	\$2,179.00	\$2,191.00	\$2,209.00
L9492EU with XL13-439	P6	Electrically unlocking outside lever, outside cylinder, inside thumbturn with deadbolt and outside key override feature (specify L9492EU with XL13-439 as special option)	\$2,389.00	\$2,401.00	\$2,419.00
LV9492EU	P6	Vandlgard electrically unlocking outside lever, outside cylinder, inside thumbturn, with deadbolt	\$2,326.00	\$2,338.00	\$2,356.00
LV9492EU with XL13-439	P6	Vandlgard electrically unlocking outside lever, outside cylinder, inside thumbturn with deadbolt and outside key override feature (specify LV9492EU with XL13-439 as special option)	\$2,536.00	\$2,548.00	\$2,566.00
L9493EL	P6	Electrically locking both levers, outside cylinder, inside thumbturn, with deadbolt	\$2,179.00	\$2,191.00	\$2,209.00
L9493EL with XL13-439	P6	Electrically locking both levers, outside cylinder, inside thumbturn with deadbolt and outside key override feature (specify L9493EL with XL13-439 as special option)	\$2,389.00	\$2,401.00	\$2,419.00
LV9493EL	P6	Vandlgard electrically locking both levers, outside cylinder, inside thumbturn, with deadbolt	\$2,326.00	\$2,338.00	\$2,356.00
LV9493EL with XL13-439	P6	Vandlgard electrically locking both levers, outside cylinder, inside thumbturn with deadbolt and outside key override feature (specify LV9493EL with XL13-439 as special option)	\$2,536.00	\$2,548.00	\$2,566.00
L9493EU	P6	Electrically unlocking both levers, outside cylinder, inside thumbturn, with deadbolt	\$2,179.00	\$2,191.00	\$2,209.00
L9493EU with XL13-439	P6	Electrically unlocking both levers, outside cylinder, inside thumbturn with deadbolt and outside key override feature (specify L9493EU with XL13-439 as special option)	\$2,389.00	\$2,401.00	\$2,419.00
LV9493EU	P6	Vandlgard electrically unlocking both levers, outside cylinder, inside thumbturn, with deadbolt	\$2,326.00	\$2,338.00	\$2,356.00
LV9493EU with XL13-439	P6	Vandlgard electrically unlocking both levers, outside cylinder, inside thumbturn with deadbolt and outside key override feature (specify LV9493EU with XL13-439 as special option)	\$2,536.00	\$2,548.00	\$2,566.00

Ⓜ Extended lead time

Note: For the Everest 29 T and Everest D family of restricted keyways (Quad, Numbered, Reversed), add \$31.00. This does not apply to Primus families. See Terms and Conditions for more information.

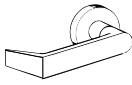

619	622	625	626	643E
US15	US19	US26	US26D	US11

COMPLETE LOCKS			LEVER STYLES		
 <p>ROSE TRIM</p> <p>Split finishes and designs will be priced at the highest list price of the design and/or finish.</p> <p>Keyed function pricing based on P6 cylinder with open S123 keyway. See page 83 for additional cylinder and keyway options.</p>			06	06	M52 M81
			07	07	
			LAT <sup>Ⓜ</sup>	LAT <sup>Ⓜ</sup>	
			LON <sup>Ⓜ</sup>	LON <sup>Ⓜ</sup>	
			FINISHES		
			626	619, 622, 625, 643e	619, 622, 625, 626, 643e
SERIES + FUNCTION					
CYL	DESCRIPTION		ROSE TRIM		
KEYED, DOUBLE CYLINDER, DEADBOLT FUNCTIONS					
L9466P	P6	Utility room/storeroom lock	\$1,457.00	\$1,469.00	\$1,487.00
L9494EL	P6	Electrically locking outside lever, inside and outside cylinders, with deadbolt	\$2,314.00	\$2,326.00	\$2,344.00
LV9494EL	P6	Vandlgard electrically locking outside lever, inside and outside cylinders, with deadbolt	\$2,461.00	\$2,473.00	\$2,491.00
L9494EU	P6	Electrically unlocking outside lever, inside and outside cylinders, with deadbolt	\$2,314.00	\$2,326.00	\$2,344.00
LV9494EU	P6	Vandlgard electrically unlocking outside lever, inside and outside cylinders, with deadbolt	\$2,461.00	\$2,473.00	\$2,491.00
L9495EL	P6	Electrically locking both levers, inside and outside cylinders, with deadbolt	\$2,314.00	\$2,326.00	\$2,344.00
LV9495EL	P6	Vandlgard electrically locking both levers, inside and outside cylinders, with deadbolt	\$2,461.00	\$2,473.00	\$2,491.00
L9495EU	P6	Electrically unlocking both levers, inside and outside cylinders, with deadbolt	\$2,314.00	\$2,326.00	\$2,344.00
LV9495EU	P6	Vandlgard electrically unlocking both levers, inside and outside cylinders, with deadbolt	\$2,461.00	\$2,473.00	\$2,491.00

<sup>Ⓜ</sup> Extended lead time

Note: For the Everest 29 T and Everest D family of restricted keyways (Quad, Numbered, Reversed), add \$31.00. This does not apply to Primus families. See Terms and Conditions for more information.

RESIDENTIAL ELECTRONIC

RESIDENTIAL MECHANICAL

COMMERCIAL WIRELESS ELECTRONIC

COMMERCIAL MECHANICAL/ELECTRIFIED

619	622	625	626	643E
US15	US19	US26	US26D	US11

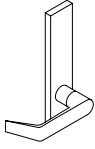
COMPLETE LOCKS			LEVER STYLES		
 <p>ESCUTCHEON TRIM</p> <p>Split finishes and designs will be priced at the highest list price of the design and/or finish.</p> <p>Keyed function pricing based on P6 cylinder with open S123 keyway. See page 83 for additional cylinder and keyway options.</p>			06	06	M52 M81
			07	07	
			LAT <sup>Ⓜ</sup>	LAT <sup>Ⓜ</sup>	
			LON <sup>Ⓜ</sup>	LON <sup>Ⓜ</sup>	
			FINISHES		
			626	619, 622, 625, 643e	619, 622, 625, 626, 643e
SERIES + FUNCTION					
CYL	DESCRIPTION				
NON-KEYED FUNCTIONS			ESCUTCHEON TRIM		
L9010	Passage latch		\$1,063.00	\$1,075.00	\$1,093.00
L9040	Bath/bedroom privacy lock		\$1,220.00	\$1,232.00	\$1,250.00
LV9040	Vandlgard bath/bedroom privacy lock		\$1,367.00	\$1,379.00	\$1,397.00
L9044	Privacy with coin turn outside		\$1,160.00	\$1,172.00	\$1,190.00
LV9044	Vandlgard privacy with coin turn outside		\$1,307.00	\$1,319.00	\$1,337.00
L9440	Privacy with deadbolt		\$1,398.00	\$1,410.00	\$1,428.00
LV9440	Vandlgard privacy with deadbolt		\$1,545.00	\$1,557.00	\$1,575.00
L9444	Privacy with deadbolt and coin turn outside, not available with L escutcheon		\$1,335.00	\$1,347.00	\$1,365.00
LV9444	Vandlgard privacy with deadbolt and coin turn outside		\$1,482.00	\$1,494.00	\$1,512.00
L9090EL	Electrically locking outside lever, no cylinder		\$1,743.00	\$1,755.00	\$1,773.00
LV9090EL	Vandlgard electrically locking outside lever, no cylinder		\$1,890.00	\$1,902.00	\$1,920.00
L9090EU	Electrically unlocking outside lever, no cylinder		\$1,743.00	\$1,755.00	\$1,773.00
LV9090EU	Vandlgard electrically unlocking outside lever, no cylinder		\$1,890.00	\$1,902.00	\$1,920.00
L9091EL	Electrically locking both levers, no cylinder		\$1,743.00	\$1,755.00	\$1,773.00
LV9091EL	Vandlgard electrically locking both levers, no cylinder		\$1,890.00	\$1,902.00	\$1,920.00
L9091EU	Electrically unlocking both levers, no cylinder		\$1,743.00	\$1,755.00	\$1,773.00
LV9091EU	Vandlgard electrically unlocking both levers, no cylinder		\$1,890.00	\$1,902.00	\$1,920.00
NON-KEYED DUMMY FUNCTIONS			ESCUTCHEON TRIM		
L0170	Half dummy trim		\$387.00	\$393.00	\$402.00
L0172	Full dummy trim		\$772.00	\$784.00	\$802.00
L9175	Half dummy trim with lock case		\$569.00	\$575.00	\$584.00
L9176	Full dummy trim with lock case		\$943.00	\$955.00	\$973.00
KEYED, SINGLE CYLINDER, NON-DEADBOLT FUNCTIONS			ESCUTCHEON TRIM		
L9050	P6	Entrance/office lock	\$1,354.00	\$1,366.00	\$1,384.00
LV9050	P6	Vandlgard entrance/office lock	\$1,501.00	\$1,513.00	\$1,531.00
L9056	P6	Entrance/office lock with automatic unlocking	\$1,477.00	\$1,489.00	\$1,507.00
L9056 with XL13-439	P6	Entrance/office lock with automatic unlocking and outside key override feature (specify L9056 with XL13-439 as special option)	\$1,687.00	\$1,699.00	\$1,717.00
LV9056	P6	Vandlgard entrance/office lock with automatic unlocking	\$1,624.00	\$1,636.00	\$1,654.00
LV9056 with XL13-439	P6	Vandlgard entrance/office lock with automatic unlocking and outside key override feature (specify LV9056 with XL13-439 as special option)	\$1,834.00	\$1,846.00	\$1,864.00
L9080	P6	Storeroom lock	\$1,354.00	\$1,366.00	\$1,384.00
LV9080	P6	Vandlgard storeroom lock	\$1,501.00	\$1,513.00	\$1,531.00

Ⓜ Extended lead time

Note: For the Everest 29 T and Everest D family of restricted keyways (Quad, Numbered, Reversed), add \$31.00. This does not apply to Primus families. See Terms and Conditions for more information.



Commercial mechanical and electrified locks

619	622	625	626	643E
US15	US19	US26	US26D	US11

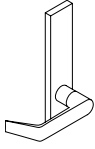
COMPLETE LOCKS			LEVER STYLES		
 <p>ESCUTCHEON TRIM</p> <p>Split finishes and designs will be priced at the highest list price of the design and/or finish.</p> <p>Keyed function pricing based on P6 cylinder with open S123 keyway. See page 83 for additional cylinder and keyway options.</p>			06	06	M52 M81
			07	07	
			17	17	
			LAT <sup>Ⓜ</sup>	LAT <sup>Ⓜ</sup>	
			LON <sup>Ⓜ</sup>	LON <sup>Ⓜ</sup>	
<b>SERIES + FUNCTION</b> <b>CYL</b> <b>DESCRIPTION</b>			626	619, 622, 625, 643e	619, 622, 625, 626, 643e
KEYED, SINGLE CYLINDER, NON-DEADBOLT FUNCTIONS			ESCUTCHEON TRIM		
L9092EL	P6	Electrically locking outside lever, outside cylinder	\$1,876.00	\$1,888.00	\$1,906.00
LV9092EL	P6	Vandlgard electrically locking outside lever, outside cylinder	\$2,023.00	\$2,035.00	\$2,053.00
L9092EU	P6	Electrically unlocking outside lever, outside cylinder	\$1,876.00	\$1,888.00	\$1,906.00
LV9092EU	P6	Vandlgard electrically unlocking outside lever, outside cylinder	\$2,023.00	\$2,035.00	\$2,053.00
L9093EL	P6	Electrically locking both levers, outside cylinder	\$1,876.00	\$1,888.00	\$1,906.00
LV9093EL	P6	Vandlgard electrically locking both levers, outside cylinder	\$2,023.00	\$2,035.00	\$2,053.00
L9093EU	P6	Electrically unlocking both levers, outside cylinder	\$1,876.00	\$1,888.00	\$1,906.00
LV9093EU	P6	Vandlgard electrically unlocking both levers, outside cylinder	\$2,023.00	\$2,035.00	\$2,053.00
KEYED, DOUBLE CYLINDER, NON-DEADBOLT FUNCTIONS			ESCUTCHEON TRIM		
L9060	P6	Apartment entrance lock	\$1,486.00	\$1,498.00	\$1,516.00
LV9060	P6	Vandlgard apartment entrance lock	\$1,633.00	\$1,645.00	\$1,663.00
L9095EL	P6	Electrically locking both levers, inside and outside cylinder	\$2,010.00	\$2,022.00	\$2,040.00
LV9095EL	P6	Vandlgard electrically locking both levers, inside and outside cylinder	\$2,157.00	\$2,169.00	\$2,187.00
L9095EU	P6	Electrically unlocking both levers, inside and outside cylinder	\$2,010.00	\$2,022.00	\$2,040.00
LV9095EU	P6	Vandlgard electrically unlocking both levers, inside and outside cylinder	\$2,157.00	\$2,169.00	\$2,187.00
KEYED, SINGLE CYLINDER, DEADBOLT FUNCTIONS			ESCUTCHEON TRIM		
L9453	P6	Entrance/office lock with deadbolt	\$1,398.00	\$1,410.00	\$1,428.00
LV9453	P6	Vandlgard entrance/office lock with deadbolt	\$1,545.00	\$1,557.00	\$1,575.00
L9456	P6	Corridor lock with deadbolt	\$1,398.00	\$1,410.00	\$1,428.00
L9456 with XL13-439	P6	Corridor lock with deadbolt and outside key override feature (specify L9456 with XL13-439 as special option)	\$1,608.00	\$1,620.00	\$1,638.00
LV9456	P6	Vandlgard corridor lock with deadbolt	\$1,545.00	\$1,557.00	\$1,575.00
LV9456 with XL13-439	P6	Vandlgard corridor lock with deadbolt and outside key override feature (specify LV9456 with XL13-439 as special option)	\$1,755.00	\$1,767.00	\$1,785.00
L9465	P6	Closet/storeroom lock	\$1,398.00	\$1,410.00	\$1,428.00
L9473	P6	Dormitory/bedroom lock	\$1,398.00	\$1,410.00	\$1,428.00
L9480	P6	Storeroom lock with deadbolt	\$1,529.00	\$1,541.00	\$1,559.00
L9480 with XL13-439	P6	Storeroom lock with deadbolt and outside key override feature (specify L9480 with XL13-439 as special option)	\$1,739.00	\$1,751.00	\$1,769.00
LV9480	P6	Vandlgard storeroom lock with deadbolt	\$1,676.00	\$1,688.00	\$1,706.00
LV9480 with XL13-439	P6	Vandlgard storeroom lock with deadbolt and outside key override feature (specify LV9480 with XL13-439 as special option)	\$1,886.00	\$1,898.00	\$1,916.00
L9492EL	P6	Electrically locking outside lever, outside cylinder, inside thumbturn, with deadbolt	\$2,208.00	\$2,220.00	\$2,238.00

Ⓜ Extended lead time

Note: For the Everest 29 T and Everest D family of restricted keyways (Quad, Numbered, Reversed), add \$31.00. This does not apply to Primus families. See Terms and Conditions for more information.

RESIDENTIAL ELECTRONIC | RESIDENTIAL MECHANICAL | COMMERCIAL WIRELESS ELECTRONIC | COMMERCIAL MECHANICAL/ELECTRIFIED

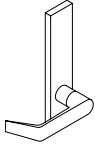

COMPLETE LOCKS			LEVER STYLES		
 <p>ESCUTCHEON TRIM</p> <p>Split finishes and designs will be priced at the highest list price of the design and/or finish.</p> <p>Keyed function pricing based on P6 cylinder with open S123 keyway. See page 83 for additional cylinder and keyway options.</p>			06	06	M52 M81
			07	07	
			17	17	
			LAT <sup>Ⓜ</sup>	LAT <sup>Ⓜ</sup>	
			LON <sup>Ⓜ</sup>	LON <sup>Ⓜ</sup>	
<b>SERIES + FUNCTION</b> <b>CYL</b> <b>DESCRIPTION</b>			626	619, 622, 625, 643e	619, 622, 625, 626, 643e
KEYED, SINGLE CYLINDER, DEADBOLT FUNCTIONS			ESCUTCHEON TRIM		
L9492EL with XL13-439	P6	Electrically locking outside lever, outside cylinder, inside thumbturn with deadbolt and outside key override feature (specify L9492EL with XL13-439 as special option)	\$2,418.00	\$2,430.00	\$2,448.00
LV9492EL	P6	Vandlgard electrically locking outside lever, outside cylinder, inside thumbturn, with deadbolt	\$2,355.00	\$2,367.00	\$2,385.00
LV9492EL with XL13-439	P6	Vandlgard electrically locking outside lever, outside cylinder, inside thumbturn with deadbolt and outside key override feature (specify LV9492EL with XL13-439 as special option)	\$2,565.00	\$2,577.00	\$2,595.00
L9492EU	P6	Electrically unlocking outside lever, outside cylinder, inside thumbturn, with deadbolt	\$2,208.00	\$2,220.00	\$2,238.00
L9492EU with XL13-439	P6	Electrically unlocking outside lever, outside cylinder, inside thumbturn with deadbolt and outside key override feature (specify L9492EU with XL13-439 as special option)	\$2,418.00	\$2,430.00	\$2,448.00
LV9492EU	P6	Vandlgard electrically unlocking outside lever, outside cylinder, inside thumbturn, with deadbolt	\$2,355.00	\$2,367.00	\$2,385.00
LV9492EU with XL13-439	P6	Vandlgard electrically unlocking outside lever, outside cylinder, inside thumbturn with deadbolt and outside key override feature (specify LV9492EU with XL13-439 as special option)	\$2,565.00	\$2,577.00	\$2,595.00
L9493EL	P6	Electrically locking both levers, outside cylinder, inside thumbturn, with deadbolt	\$2,208.00	\$2,220.00	\$2,238.00
L9493EL with XL13-439	P6	Electrically locking both levers, outside cylinder, inside thumbturn with deadbolt and outside key override feature (specify L9493EL with XL13-439 as special option)	\$2,418.00	\$2,430.00	\$2,448.00
LV9493EL	P6	Vandlgard electrically locking both levers, outside cylinder, inside thumbturn, with deadbolt	\$2,355.00	\$2,367.00	\$2,385.00
LV9493EL with XL13-439	P6	Vandlgard electrically locking both levers, outside cylinder, inside thumbturn with deadbolt and outside key override feature (specify LV9493EL with XL13-439 as special option)	\$2,565.00	\$2,577.00	\$2,595.00
L9493EU	P6	Electrically unlocking both levers, outside cylinder, inside thumbturn, with deadbolt	\$2,208.00	\$2,220.00	\$2,238.00
L9493EU with XL13-439	P6	Electrically unlocking both levers, outside cylinder, inside thumbturn with deadbolt and outside key override feature (specify L9493EU with XL13-439 as special option)	\$2,418.00	\$2,430.00	\$2,448.00
LV9493EU	P6	Vandlgard electrically unlocking both levers, outside cylinder, inside thumbturn, with deadbolt	\$2,355.00	\$2,367.00	\$2,385.00
LV9493EU with XL13-439	P6	Vandlgard electrically unlocking both levers, outside cylinder, inside thumbturn with deadbolt and outside key override feature (specify LV9493EU with XL13-439 as special option)	\$2,565.00	\$2,577.00	\$2,595.00

Ⓜ Extended lead time

Note: For the Everest 29 T and Everest D family of restricted keyways (Quad, Numbered, Reversed), add \$31.00. This does not apply to Primus families. See Terms and Conditions for more information.

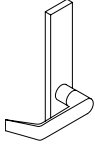

619	622	625	626	643E
US15	US19	US26	US26D	US11

COMPLETE LOCKS			LEVER STYLES		
 <p>ESCUTCHEON TRIM</p> <p>Split finishes and designs will be priced at the highest list price of the design and/or finish.</p> <p>Keyed function pricing based on P6 cylinder with open S123 keyway. See page 83 for additional cylinder and keyway options.</p>			06	06	M52 M81
			07	07	
			LAT <sup>Ⓢ</sup>	LAT <sup>Ⓢ</sup>	
			LON <sup>Ⓢ</sup>	LON <sup>Ⓢ</sup>	
			FINISHES		
			626	619, 622, 625, 643e	619, 622, 625, 626, 643e
SERIES + FUNCTION					
CYL	DESCRIPTION		ESCUTCHEON TRIM		
KEYED, DOUBLE CYLINDER, DEADBOLT FUNCTIONS					
L9466P	P6	Utility room/storeroom lock	\$1,486.00	\$1,498.00	\$1,516.00
L9494EL	P6	Electrically locking outside lever, inside and outside cylinders, with deadbolt	\$2,343.00	\$2,355.00	\$2,373.00
LV9494EL	P6	Vandlgard electrically locking outside lever, inside and outside cylinders, with deadbolt	\$2,490.00	\$2,502.00	\$2,520.00
L9494EU	P6	Electrically unlocking outside lever, inside and outside cylinders, with deadbolt	\$2,343.00	\$2,355.00	\$2,373.00
LV9494EU	P6	Vandlgard electrically unlocking outside lever, inside and outside cylinders, with deadbolt	\$2,490.00	\$2,502.00	\$2,520.00
L9495EL	P6	Electrically locking both levers, inside and outside cylinders, with deadbolt	\$2,343.00	\$2,355.00	\$2,373.00
LV9495EL	P6	Vandlgard electrically locking both levers, inside and outside cylinders, with deadbolt	\$2,490.00	\$2,502.00	\$2,520.00
L9495EU	P6	Electrically unlocking both levers, inside and outside cylinders, with deadbolt	\$2,343.00	\$2,355.00	\$2,373.00
LV9495EU	P6	Vandlgard electrically unlocking both levers, inside and outside cylinders, with deadbolt	\$2,490.00	\$2,502.00	\$2,520.00

Ⓢ Extended lead time

Note: For the Everest 29 T and Everest D family of restricted keyways (Quad, Numbered, Reversed), add \$31.00. This does not apply to Primus families. See Terms and Conditions for more information.

RESIDENTIAL ELECTRONIC

RESIDENTIAL MECHANICAL

COMMERCIAL WIRELESS ELECTRONIC

COMMERCIAL MECHANICAL/ELECTRIFIED



COMPLETE LOCKS

CYLINDER ADJUSTMENTS

Keyed locks on the previous pages are priced including the P6 cylinder with open keyway. Provided below are pricing adjustments based on other available cylinder types. For Primus and Primus XP cylinders, order lock less cylinder and order the Primus or Primus XP cylinder separately.

For complete details on cylinders, tailpieces, keying and keys, including cylinders sold separate, see Schlage Commercial price book.

Ordering instructions: Add suffix to lock function. Ex: L9050J (L9050 function less full size core)

<b>CYLINDER ADJUSTMENTS</b>		
Restricted keyways include: Everest 29 R and T keyways, Everest B and D keyways and Classic (Reverse/Quad/Numbered) keyways		
<b>Description</b>	<b>Specify</b>	<b>Price adjustment</b>
Conventional 6-pin cylinder	P6	No charge
Conventional 6-pin cylinder, keyed 5	P	No charge
FSIC (Full size interchangeable core) (Furnished 1-bitted with two 6-pin keys unless otherwise specified)	R	\$106.00
FSIC – Construction Core (requires 50-231 handling charge per cylinder)	T	\$106.00
Less FSIC	J	No charge
SFIC (Small format interchangeable core) 7-pin Everest patented core (N/A with faculty restroom/hotel functions L9485 or L9486) (specify key symbol; see Terms and Conditions for more details)	G7	\$0.00
Refundable Construction SFIC (N/A with faculty restroom/hotel functions L9485 or L9486) (requires 50-231 handling charge of \$15.20 per cylinder)	H	\$64.00
Disposable Construction SFIC (N/A with faculty restroom/hotel functions L9485 or L9486)	BDC	-\$16.00
Less SFIC (N/A with faculty restroom/hotel functions L9485 or L9486)	B	-\$20.00
Handling charge for construction core (assessed per cylinder, non-refundable)	50-231	\$15.20

Construction cores (T and H) have an additional handling charge 50-231.

Note: Control keys are not furnished with locks and must be purchased separately. See Keys and Keying in Schlage Commercial Price Book. Interchangeable cores are not available with concealed cylinders.

**COMPLETE LOCKS**

**ARMOR FRONTS**

Specify on order only if requesting an option other than the default.

<b>ARMOR FRONTS, L9000</b>		
<b>1-1/4" Wide (Standard armor size for 1-3/4" and larger door thicknesses)</b>	<b>Specify</b>	<b>Price adjustment</b>
Blank (L9175, L9176)	09-661	No charge
Latch only (L9010, L9040, L9044)	09-662	
Latch x aux latch (L9050, L9056, L9060, L9070, L9071, L9080, L9082, L9090/91/92/93/95')	09-663	
Latch x aux latch (L9076, L9077)	09-713	
Latch x deadbolt (L9440, L9444, L9456, L9457, L9465, L9466, L9473, L9496)	09-664	
Deadbolt (L9460, L9462, L9463, L9464)	09-665	
Latch x aux latch x deadbolt (L9453, L9458, L9480, L9485, L9486, L9492/93/94/95)	09-666	
Deadbolt armor (L460, L462, L463, L464, L480, L496)	09-717	
<b>1-1/16" Wide (recommended armor size for doors thinner than 1-3/4", including 1-3/8" doors)</b>	<b>Specify</b>	<b>Price adjustment</b>
Blank (L9175, L9176)	09-667	No charge
Latch only (L9010, L9040, L9044)	09-668	
Latch x aux latch (L9050, L9056, L9060, L9070, L9071, L9080, L9082, L9090/91/92/93/95')	09-669	
Latch x aux latch (L9076, L9077)	09-718	
Latch x deadbolt (L9440, L9444, L9456, L9457, L9465, L9466, L9473, L9496)	09-670	
Deadbolt (L9460, L9462, L9463, L9464)	09-671	
Latch x aux latch x deadbolt (L9453, L9458, L9480, L9485, L9486, L9492/93/94/95)	09-672	

1. For L9090/91/92/93/95 with DPS, use armor 09-666 (1-1/4" wide) or 09-672 (1-1/16 wide).

**COMPLETE LOCKS**

**STRIKES**

Specify on order only if requesting an option other than the default.

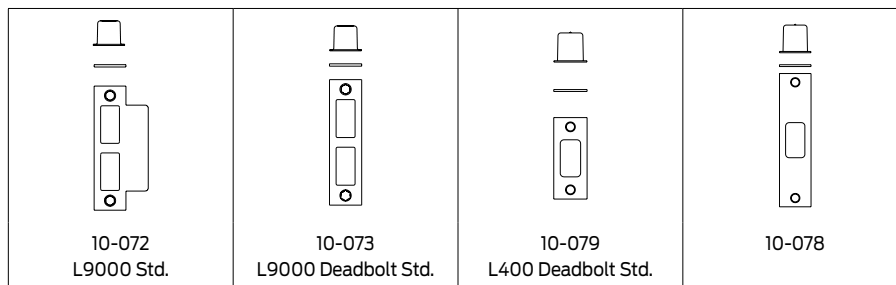

<b>STRIKES, L9000</b>		
<b>Strikes, L9000 Series</b>	<b>Specify</b>	<b>Price adjustment</b>
1-1/4" x 4 7/8" square corner strike + box, 1-3/16" lip length, standard L9000 strike	10-072	No charge
1-1/4" x 4 7/8" square corner strike + box; specify lip length (xx) as 7/8", 1" or 1-1/2"	10-072 xx	
Deadbolt lock strike, standard for L9460, L9462, L9463 and L9464	10-073	
Door frame strike reinforcer (finish not applicable)	37-015	
<b>Strikes, L400 Series</b>	<b>Specify</b>	<b>Price adjustment</b>
1-1/4" x 4-7/8" square corner strike + box	10-078	No charge
1-1/8" x 3-1/2" square corner strike + box, ANSI 115.5 prep, standard L400 strike	10-079	

## ND SERIES ■ OVERVIEW

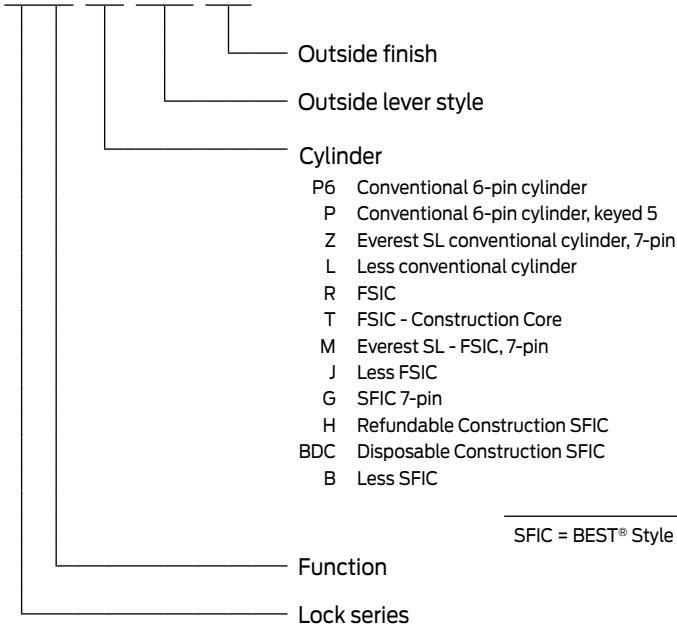
**Product identification**
**ND53 . P6 . RHO . 626**

**Finish codes and descriptions**

BHMA code		Description
619	(US 15)	Satin Nickel
622	(US 19)	Matte Black
625	(US 26)	Bright Chrome
626	(US 26D)	Satin Chrome
643e	(US 11)	Aged Bronze

**Standard features**

Certifications	ANSI/BHMA Certified A156.2-2011, Series 4000, Grade 1, UL Listed for 3-hour fire door
Latch	1-1/8" x 2-1/4", square corner faceplate, 1" housing diameter, 1/2" throw
Strike	1-1/4" x 4-7/8", ANSI square corner, no box
Backset	2-3/4"
Cylinder	6-pin solid brass, keyed 6-pin, S123 keyway, keyed different (KD)
Door range	1-5/8"–2-1/8" for all functions except ND85; 1-3/4"–2" for ND85
Keys	Two nickel silver cut keys per lock, 6-pin, S123 section







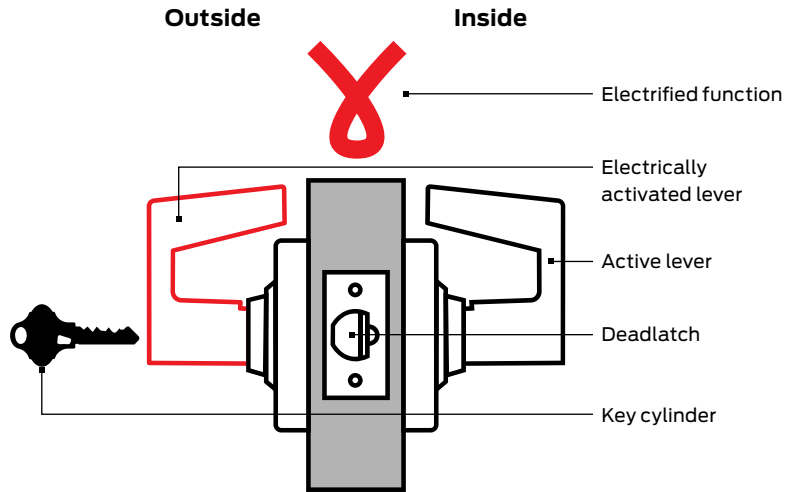



RESIDENTIAL ELECTRONIC  
RESIDENTIAL MECHANICAL  
COMMERCIAL WIRELESS ELECTRONIC

**Mechanical lock functions**

Legend

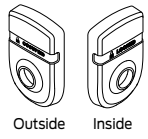

Key

-  Fixed lever
  -  Blank plate
  -  Springlatch
  -  Push button
  -  Push/turn button
  -  Hospital turn button
-  180° lock status indicator option available  
Outside    Inside
  -  High-security ligature resistant trim available
  -  Instruction rose available (626 only; type is specific to function)
  - 

Product Identification Guide

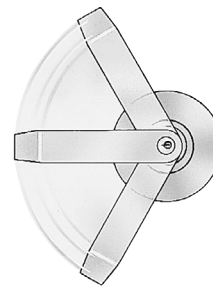
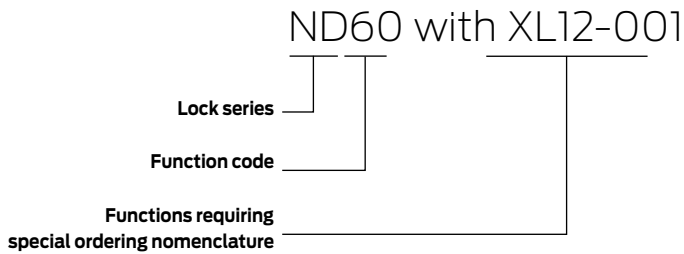

**Vandlgard® functions.**

Some functions feature Vandlgard locked lever protection. It allows the outside lever to rotate freely up and down when locked to limit the ability of vandals to apply excessive force to the chassis helping to prevent damage to internal components.

**FUNCTIONS**

ANSI/BHMA Certified A156.2-2011, Series 4000, Grade 1, UL Listed for 3-hour fire door.

**MECHANICAL NON-KEYED**

SCHLAGE

ANSI

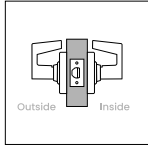
**ND10**
**Passage latch**

- Levers both sides; springlatch
- Latch retracted by lever from either side at all times
- Inside lever always free for immediate egress

To order configured with Request to Exit (RX), specify RX under special options.

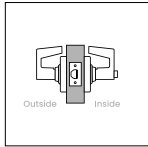
**ND40**
**Bath/bedroom privacy lock**

- Lever with emergency release recessed slot outside; push button in lever inside; springlatch
- In unlocked state latch is retracted by either lever
- Outside lever is made inoperative by pushing button on inside lever
- Rotating inside lever retracts latch and releases button unlocking outside lever; closing door also unlocks preventing lock-out
- Emergency unlock: an emergency key (sold separate) or small, flat screwdriver inserted in outside lever and turned releases button to unlock
- Inside lever always free for immediate egress

Note: Locks ordered with indicator trim fit 1-3/4" doors. Sold separate spacer kits allow application to doors 1-3/8" to 1-11/16".

To order an emergency key use part number 35-270.

**MECHANICAL KEYED**

SCHLAGE

ANSI

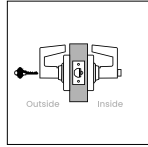
**ND50**
**Entrance/office lock**

- Lever with key cylinder outside; push button in lever inside; deadlatch
- In unlocked state latch is retracted by either lever
- Outside lever is made inoperative by pushing button on inside lever; key outside does not lock
- Key outside or rotating inside lever retracts latch and releases button unlocking outside lever
- Inside lever always free for immediate egress

Note: Locks ordered with indicator trim fit 1-3/4" doors. Sold separate spacer kits allow application to doors 1-3/8" to 1-11/16".

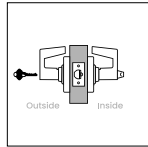
**ND53**
**Entrance lock**

- Lever with key cylinder outside; push/turn button in lever inside; deadlatch
- In unlocked state latch is retracted by either lever
- Outside lever is made inoperative by pushing button or pushing and turning button on inside lever; key outside does not lock
- Pushed button unlocking: key outside or rotating inside lever retracts latch and releases button unlocking outside lever
- Pushed/turned button unlocking: key outside or rotating inside lever retracts latch but does not unlock outside lever; rotate inside button to start position to allow button release and unlocking by key or by rotating inside lever
- Inside lever always free for immediate egress

Caution: Egress without fully releasing the push/turn button can result in lock-out situations.

Note: Locks ordered with indicator trim fit 1-3/4" doors. Sold separate spacer kits allow application to doors 1-3/8" to 1-11/16".

**MECHANICAL KEYED**

SCHLAGE

ANSI

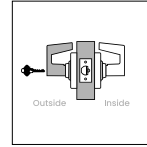
**ND80**
**Storeroom lock**

- Lever with key cylinder outside; lever inside; deadlatch
- Outside lever always fixed; latch retracted by inside lever
- Key in outside lever retracts latch only
- Inside lever always free for immediate egress

To order configured with Request to Exit (RX), specify RX under special options.

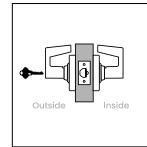
**ND81**
**Accessible storeroom lock**

- Lever with key cylinder outside; lever inside; deadlatch
- Outside lever is always fixed when key is not present; latch retracted by inside lever
- Key outside turned counter-clockwise retracts latch; 180° clockwise rotation of key allows outside lever to retract latch
- Inside lever always free for immediate egress

To order configured with Request to Exit (RX), specify RX under special options.

**MECHANICAL NON-KEYED DUMMY**

SCHLAGE

ANSI

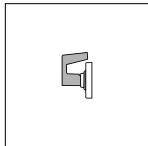
**ND170**
**Single dummy trim**

- Fixed lever one side only; no latch or chassis
- Used for door pull or matching inactive trim

See page 86 for more information on trim options.

**FUNCTIONS**

ANSI/BHMA Certified A156.2-2011, Series 4000, Grade 1, UL Listed for 3-hour fire door.

WIRED ELECTRIFIED		WIRED ELECTRIFIED		WIRED ELECTRIFIED	
SCHLAGE	ANSI	SCHLAGE	ANSI	SCHLAGE	ANSI

**ND80EL**

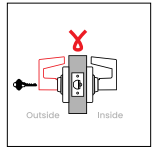

**Storeroom lock, electrically locked outside lever (fail safe)**



- Lever with key cylinder outside; lever inside; deadlatch
- Powered state: outside lever continuously locked (when in EL mode)
- When power is removed (via switch or power failure), in EL mode either lever will retract latch
- Key outside retracts latch but cannot change the normal locked or unlocked state of the outside lever
- Inside lever always free for immediate egress

Note: Auto detects 12 or 24V DC. Chassis mounted switch allows field selectable EL/EU setting.

Ordering: unless EL or EU is specified, order will default to an EU setting. Optional RX function can be ordered configured by specifying RX under special options or add later using kit part N123-062.

**ND96EL**

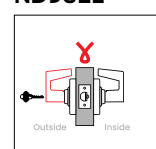

**Vandlgard® storeroom lock, electrically locked outside lever (fail safe)**



- Lever with key cylinder outside; lever inside; deadlatch
- Powered state: outside lever continuously locked (when in EL mode)
- Vandlgard® feature allows outside lever, when locked, to rotate without engaging latch
- When power is removed (via switch or power failure), in EL mode either lever will retract latch
- Key outside retracts latch but cannot change the normal locked or unlocked state of the outside lever
- Inside lever always free for immediate egress

Note: Auto detects 12 or 24V DC. Chassis mounted switch allows field selectable EL/EU setting.

Ordering: unless EL or EU is specified, order will default to an EU setting. Optional RX function can be ordered configured by specifying RX under special options or add later using kit part N123-062.

**ND96EU**

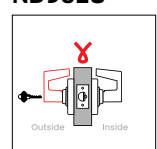

**Vandlgard® storeroom lock, electrically unlocked outside lever (fail secure)**



- Lever with key cylinder outside; lever inside; deadlatch
- Powered state: outside lever continuously unlocked (when in EU mode)
- When power is removed (via switch or power failure), in EU mode outside lever is locked
- Vandlgard® feature allows outside lever, when locked, to rotate without engaging latch
- Key outside retracts latch but cannot change the normal locked or unlocked state of the outside lever
- Inside lever always free for immediate egress

Note: Auto detects 12 or 24V DC. Chassis mounted switch allows field selectable EL/EU setting.

To order configured with Request to Exit (RX), specify RX under special options.

**ND80EU**

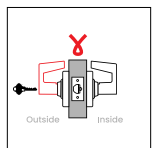

**Storeroom lock, electrically unlocked outside lever (fail secure)**



- Lever with key cylinder outside; lever inside; deadlatch
- Powered state: outside lever continuously unlocked (when in EU mode)
- When power is removed (via switch or power failure), in EU mode outside lever is locked
- Key outside retracts latch but cannot change the normal locked or unlocked state of the outside lever
- Inside lever always free for immediate egress

Note: Auto detects 12 or 24V DC. Chassis mounted switch allows field selectable EL/EU setting.

To order configured with Request to Exit (RX), specify RX under special options.

See page 86 for more information on trim options.



**LEVER DESIGNS**

**ATHENS (ATH)**

Tactile option: 8AT (milled)

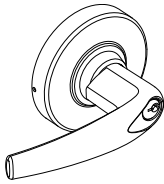

- Lever: Grade 1  
 Cores:
- KIL
  - FSIC
  - SFIC
  - L-SA
  - L-CO
  - J-SA
  - J-CO6
  - J-MED
  - J-YA6

**BROADWAY (BRW)**

Tactile option: 8BY (knurled)

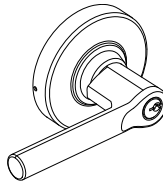

- Lever: Grade 1  
 Cores:
- KIL
  - FSIC
  - SFIC

**BOARDWALK (BRK)**

Tactile option: 8BK (knurled)

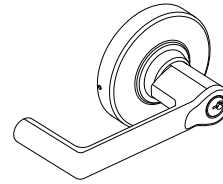

- Lever: Grade 1  
 Cores:
- KIL
  - FSIC
  - SFIC

Available roses: Rhodes (RHO)	Available roses: Rhodes (RHO)	Available roses: Rhodes (RHO)
-------------------------------	-------------------------------	-------------------------------

**LATITUDE (LAT)**

Tactile option: 8LT (milled)

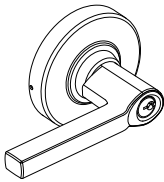

- Lever: Grade 1  
 Cores:
- KIL
  - FSIC
  - SFIC

**LONGITUDE (LON)**

Tactile option: 8LN (milled)

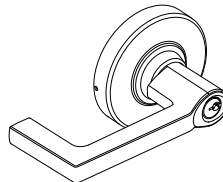

- Lever: Grade 1  
 Cores:
- KIL
  - FSIC
  - SFIC

**OMEGA (OME)**

Tactile option: 8OM (milled)

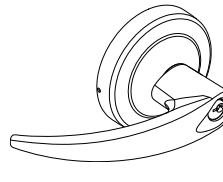

- Lever: Grade 1  
 Cores:
- KIL
  - FSIC
  - SFIC

Available roses: Rhodes (RHO)	Available roses: Rhodes (RHO)	Available roses: Omega (OME)
-------------------------------	-------------------------------	------------------------------

**RHODES (RHO)**

Tactile option: 8RO (milled)

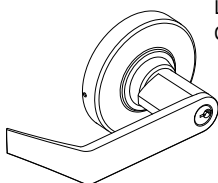

- Lever: Grade 1  
 Cores:
- KIL
  - FSIC
  - SFIC
  - L-SA
  - L-CO
  - J-SA
  - J-CO6
  - J-CO7
  - J-MED
  - J-YA6
  - J-YA7

**SPARTA (SPA)**

Tactile option: 8SP (milled)

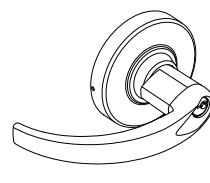

- Lever: Grade 1  
 Cores:
- KIL
  - FSIC
  - SFIC
  - L-SA
  - L-CO
  - J-SA
  - J-CO6
  - J-MED
  - J-YA6

**TUBULAR (TLR)**

Tactile option: 8TR (knurled)

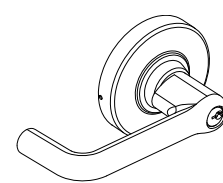

- Lever: Grade 1  
 Cores:
- KIL
  - FSIC
  - SFIC
  - L-SA
  - L-CO
  - J-SA
  - J-CO6
  - J-MED
  - J-YA6

Available roses: Rhodes (RHO)	Available roses: Rhodes (RHO)	Available roses: Rhodes (RHO)
-------------------------------	-------------------------------	-------------------------------

**ROSE DESIGNS**

**RHODES (RHO)**

3-7/16" (87 mm) diameter

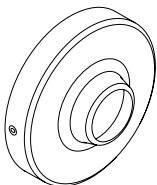

**OMEGA (OME)**

3-7/16" (87 mm) diameter

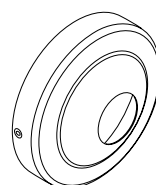



Commercial mechanical and electrified locks

619	622	625	626	643E
US15	US19	US26	US26D	US11

COMPLETE LOCKS			LEVER STYLES	
<p>Split finishes and designs will be priced at the highest list price of the design and/or finish.</p> <p>Keyed function pricing based on P6 cylinder with open S123 keyway. See next page for additional cylinder and keyway options.</p> <p>Electrified functions come with Allegion Connect.</p>			ATH	ATH
			BRW	BRW
			BRK	BRK
			LAT	LAT
			LON	LON
			RHO	RHO
			SPA	SPA
			TLR	TLR
			FINISHES	
<p><b>SERIES + FUNCTION</b></p>			626	619, 622, 625 <sup>Ⓜ</sup> , 643e <sup>Ⓜ</sup>
<p><b>CYL DESCRIPTION</b></p>				
NON-KEYED FUNCTIONS				
ND10		Passage latch	\$657.00	\$669.00
ND40		Bath/bedroom privacy lock	\$757.00	\$769.00
NON-KEYED DUMMY FUNCTIONS				
ND170		Single dummy trim	\$184.00	\$190.00
KEYED, SINGLE CYLINDER, NON-DEADBOLT FUNCTIONS				
ND50	P6	Entrance/office lock	\$896.00	\$908.00
ND53	P6	Entrance lock	\$896.00	\$908.00
ND80	P6	Storeroom lock	\$896.00	\$908.00
ND80EL	P6	Storeroom lock, electrically locked (fail safe)	\$1,234.00	\$1,246.00
ND80EU	P6	Storeroom lock, electrically unlocked (fail secure)	\$1,234.00	\$1,246.00
ND96EL	P6	Vandlgard storeroom lock, electrically locked (fail safe)	\$1,355.00	\$1,367.00
ND96EU	P6	Vandlgard storeroom lock, electrically unlock (fail secure)	\$1,355.00	\$1,367.00

<sup>Ⓜ</sup> Extended lead time

All electrified functions are compatible with the Allegion Connect harnesses. For additional options, including competitive cores, please see the Schlage Commercial Price Book.

RESIDENTIAL ELECTRONIC

RESIDENTIAL MECHANICAL

COMMERCIAL WIRELESS ELECTRONIC

COMMERCIAL MECHANICAL/ELECTRIFIED

**COMPLETE LOCKS** CYLINDER ADJUSTMENTS

Keyed locks on the previous page are priced including the P6 cylinder with open keyway. Provided below are pricing adjustments based on other available cylinder types. For Primus and Primus XP cylinders, order lock less cylinder and order the Primus or Primus XP cylinder separately.

For complete details on cylinders, tailpieces, keying and keys, including cylinders sold separate, see Schlage Commercial price book.

<b>CYLINDER ADJUSTMENTS</b>		
Restricted keyways include: Everest 29 R and T keyways, Everest B and D keyways and Classic (Reverse/Quad/Numbered) keyways		
Description	Specify	Price adjustment
Conventional 6-pin cylinder	P6	No charge
Conventional 6-pin cylinder, keyed 5	P	No charge
Less conventional cylinder	L	-\$94.00
FSIC (Full size interchangeable core)	R	\$46.00
Less FSIC	J	-\$60.00
SFIC (Small format interchangeable core) 7-pin	G	\$0.00
Refundable Construction SFIC (requires 50-231 handling charge per cylinder)	H	\$30.00
Disposable Construction SFIC	BDC	-\$60.00
Less SFIC	B	-\$60.00
Handling charge for construction core (assessed per cylinder, non-refundable)	50-231	\$15.20

Note: Construction cores (T and H) have an additional handling charge 50-231.

**COMPLETE LOCKS** LATCHES

Specify on order only if requesting an option other than the default.

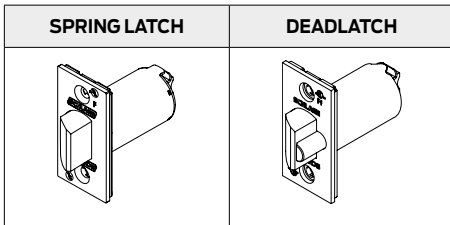

<b>LATCHES<sup>1</sup></b>				
<b>SPRING LATCH</b>				
Default	Faceplate description	Backset	Specify	Price adjustment
▪	Square corner, 1-1/8" x 2-1/4" (no substitutes for HSLR trim)	2-3/4"	13-248	No charge
<b>DEADLATCH</b>				
Default	Faceplate description	Backset	Specify	Price adjustment
▪	Square corner, 1-1/8" x 2-1/4" (no substitutes for HSLR trim)	2-3/4"	13-247	No charge
	Square corner, 1-1/8" x 2-1/4"	2-3/8"	14-047	\$46.70
	Square corner, 1" x 2-1/4"	2-3/8"	14-048	\$46.70

1. All latch extensions require reinforcement when used in hollow metal door applications.

**COMPLETE LOCKS** STRIKES

Specify on order only if requesting an option other than the default.

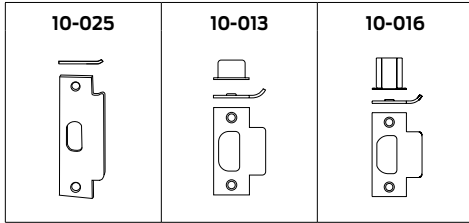

STRIKES					
Default	Description	Lip length	Specify		Price adjustment
			Strike part number	Lip length	
▪	ANSI, no box, 1-1/4" x 4-7/8" (no substitutes for HSLR trim)	1-13/16"	10-025	-	No charge
	ANSI, no box, 1-1/4" x 4-7/8" (no substitutes for HSLR trim)	1-3/8"	10-025	LIP1-3/8	\$42.80
	ANSI, no box, 1-1/4" x 4-7/8" (no substitutes for HSLR trim)	1-1/2"	10-025	LIP1-1/2	\$42.80
	Square corner, T-strike, box, 1-1/8" x 2-3/4"	1-1/8"	10-013	LIP1-1/8	No charge
	Square corner, T-strike, box, 1-1/2" x 2-3/4"	1-1/2"	10-013	LIP1-1/2	No charge
	Square corner, T-strike, deep box, fire door latch	1-1/8"	10-016	-	No charge
	Box for ANSI strike (Must be specified)	-	K510-066	-	No charge

**COMPLETE LOCKS** DOOR DIMENSIONS

**DOOR THICKNESS AND EXTENDED**

- Standard chassis covers 1-5/8" – 2-1/8" for all functions except ND85 (1-3/4" – 2")
- Specify door thickness and extended on order only if different than 1-3/4" thick door
- Door thickness should be specified to the nearest 1/8"
- If extended option is not specified (EE/EO/EI), order will be shipped Extended Equal (EE)
- ED chassis need to be ordered via the RFQ process to ensure accuracy - pricing to be provided

NON-STANDARD DOOR THICKNESS AND EXTENDED OPTIONS			
Specify door thickness in to the nearest 1/8" increment.			
Door thickness	Specify		Price adjustment
	Door thickness	Extended	
1-3/8" thick doors - 2 chassis spacers (XN12-012) required	DT[Door thickness]	.[Select EE, EI, EO]	No charge

RESIDENTIAL ELECTRONIC  
RESIDENTIAL MECHANICAL  
COMMERCIAL WIRELESS ELECTRONIC  
COMMERCIAL MECHANICAL/ELECTRIFIED

## ALX SERIES ■ OVERVIEW

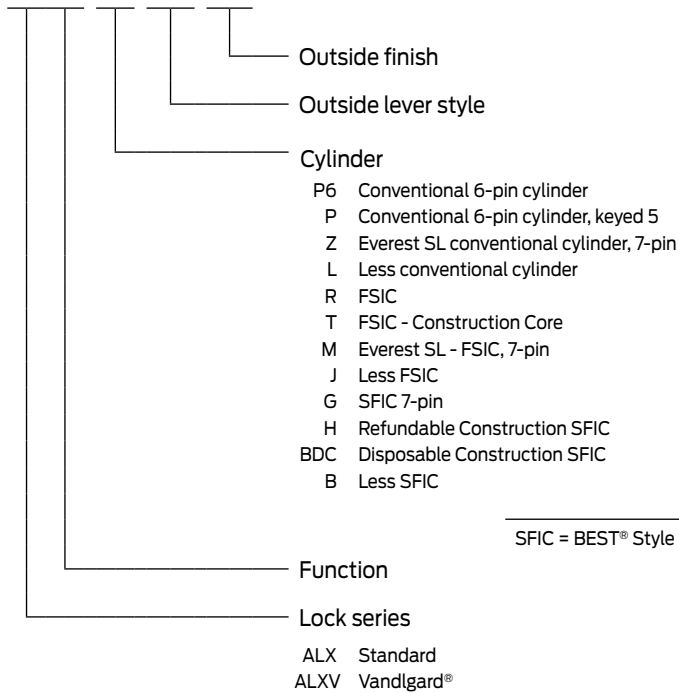
**Product identification**
**ALX53 . P6 . SAT . 626**

**Finish codes and descriptions**

BHMA code		Description
619	(US 15)	Satin Nickel
622	(US 19)	Matte Black
625	(US 26)	Bright Chrome
626	(US 26D)	Satin Chrome
643e	(US 11)	Aged Bronze

**Standard features**

Certification	ANSI/BHMA Certified A156.2-2011, Series 4000, Grade 2, UL Listed for 3-hour fire door
Latch	1-1/8" x 2-1/4" Square corner faceplate, 7/8" housing diameter with 1" diameter sleeve, 1/2" throw
Strike	1-1/4" x 4-7/8" ANSI, square corner, no dust box
Backset	2-3/4"
Cylinder	6-pin solid brass, keyed 6-pin, S123 keyway, keyed different (KD)
Door range	1-3/8"-1-3/4"
Keys	Two nickel silver cut keys per lock, 6-pin, S123 section

**FUNCTIONS**

ANSI/BHMA Certified A156.2-2011, Series 4000, Grade 2, UL Listed for 3-hour fire door.

**NON-KEYED LOCKS**

SCHLAGE ANSI

**ALX10 F75**

**Passage latch**

No cylinder; plain lever both sides; spring latch. Both levers always unlocked.

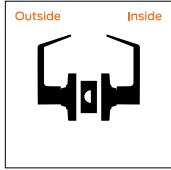

**ALX40 F76  
ALXV40**

**Bath/bedroom privacy lock**

No cylinder; coin turn outside; pushbutton inside; spring latch. Inside push button locks outside lever. Turn inside lever or close door to release button and prevent lock-out; outside coin turn provides emergency access. Field selectable Vandlgard® feature. Inside lever is always free for immediate egress.

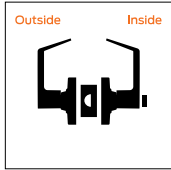

**NON-KEYED DUMMY**

SCHLAGE ANSI

**ALX170**

**Single dummy trim**

No cylinder; rigid plain lever outside; no hardware inside; no latch. Use as door pull or matching inactive trim.

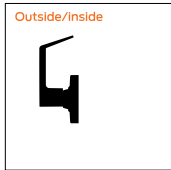

**KEYED LOCKS**

SCHLAGE ANSI

**ALX50 F82  
ALXV50**

**Entrance/office lock**

Cylinder outside; push button inside; deadlatch. Inside push button locks outside lever. Unlock with key or by rotating inside lever. Field selectable Vandlgard feature. Inside lever always free for immediate egress.

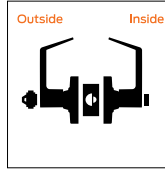

**ALX53 F109  
ALXV53**

**Entrance lock**

Cylinder outside; push/turn button inside; deadlatch. Inside button locks outside lever by pushing button or pushing and turning button. Pushed button: unlock with key or by rotating inside lever. Push/turn button: key retracts latch only; unlock by returning button to home position then use key or rotate inside lever. Field selectable Vandlgard feature. Inside lever always free for immediate egress.

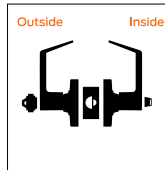

**ALX70 F84  
ALXV70**

**Storeroom lock, electrically locked (fail safe)**

Outside lever continuously locked electrically. Unlocked by key outside or by switch or power failure. Auxiliary latch deadlocks latch bolt when door is closed. Inside lever always unlocked for immediate egress. Also available with Request to Exit (RX) function.

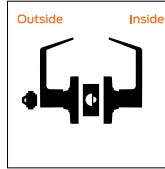

**ALX80 F86  
ALXV80**

**Storeroom lock**

Cylinder outside; plain lever inside; deadlatch. Outside lever always locked. Key retracts the latch. Field selectable Vandlgard feature. Inside lever always free for immediate egress.

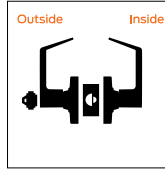

**LEVER DESIGNS**

**ATHENS (ATH)**

Tactile option: 8AT (milled)

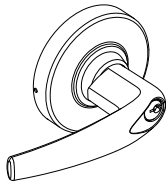

- Lever: Grade 1  
Cores:
- KIL
  - FSIC
  - SFIC
  - L-SAR
  - L-CO6
  - J-SAR
  - J-CO6

**BROADWAY (BRW)**

Tactile option: 8BY (knurled)

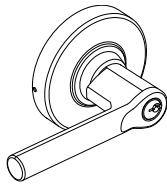

- Lever: Grade 1  
Cores:
- KIL
  - FSIC
  - SFIC

**BOARDWALK (BRK)**

Tactile option: 8BK (knurled)

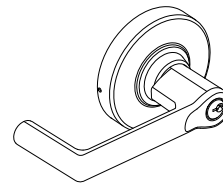

- Lever: Grade 1  
Cores:
- KIL
  - FSIC
  - SFIC

Available roses: Rhodes (RHO)

**LATITUDE (LAT)**

Tactile option: 8LT (milled)

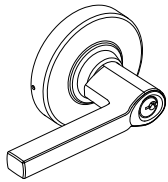

- Lever: Grade 1  
Cores:
- KIL
  - FSIC
  - SFIC

**LONGITUDE (LON)**

Tactile option: 8LN (milled)

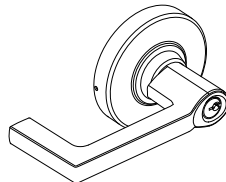

- Lever: Grade 1  
Cores:
- KIL
  - FSIC
  - SFIC

**OMEGA (OME)**

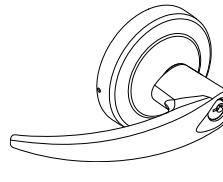

- Lever: Grade 1  
Cores:
- KIL
  - FSIC
  - SFIC

Available roses: Rhodes (RHO)

**RHODES (RHO)**

Tactile option: 8RO (milled)

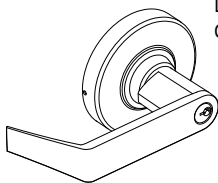

- Lever: Grade 1  
Cores:
- KIL
  - FSIC
  - SFIC
  - L-SAR
  - L-CO6
  - J-SAR
  - J-CO6
  - J-CO7

**SATURN (SAT)**

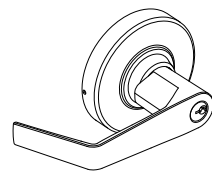

- Lever: Grade 1  
Cores:
- KIL

**SPARTA (SPA)**

Tactile option: 8SP (milled)

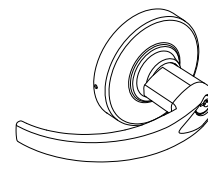

- Lever: Grade 1  
Cores:
- KIL
  - FSIC
  - SFIC
  - L-SAR
  - L-CO6
  - J-SAR
  - J-CO6

Available roses: Rhodes (RHO)

**TUBULAR (TLR)**

Tactile option: 8TR (knurled)

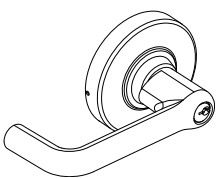

- Lever: Grade 1  
Cores:
- KIL
  - FSIC
  - SFIC
  - L-SAR
  - L-CO6
  - J-SAR
  - J-CO6

Available roses: Rhodes (RHO)

619	622	625	626	643E
US15	US19	US26	US26D	US11

**ROSE DESIGNS**
**RHODES (RHO)**

3-7/16" (87 mm) diameter

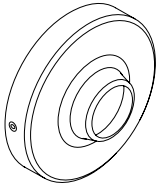
**OMEGA (OME)**

3-7/16" (87 mm) diameter

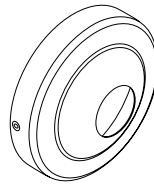

COMPLETE LOCKS		LEVER STYLES			
ALXV = ALX with Vandlgard feature Split finishes and designs will be priced at the highest list price of the design and/or finish. Keyed function pricing based on P6 cylinder with open S123 keyway. See next page for additional cylinder and keyway options.		SAT	SAT	ATH	ATH
				BRW	BRW
		FINISHES			
<b>SERIES + FUNCTION</b> <b>CYL</b> <b>DESCRIPTION</b>		626	619, 622, 625 <sup>Ⓜ</sup> , 643e <sup>Ⓜ</sup>	626	619, 622, 625 <sup>Ⓜ</sup> , 643e <sup>Ⓜ</sup>
<b>NON-KEYED FUNCTIONS</b>					
ALX10	Passage latch	\$269.00	\$281.00	\$291.00	\$303.00
ALX40	Bath/bedroom privacy lock	\$305.00	\$317.00	\$327.00	\$339.00
ALXV40	Vandlgard bath/bedroom privacy lock	\$305.00	\$317.00	\$327.00	\$339.00
<b>NON-KEYED DUMMY FUNCTIONS</b>					
ALX170	Single dummy trim	\$168.00	\$174.00	\$179.00	\$185.00
<b>KEYED, SINGLE CYLINDER, NON-DEADBOLT FUNCTIONS</b>					
ALX50	P6 Entrance/office lock	\$380.00	\$392.00	\$402.00	\$414.00
ALXV50	P6 Vandlgard entrance/office lock	\$380.00	\$392.00	\$402.00	\$414.00
ALX53	P6 Entrance lock	\$380.00	\$392.00	\$402.00	\$414.00
ALXV53	P6 Vandlgard entrance lock	\$380.00	\$392.00	\$402.00	\$414.00
ALX70	P6 Classroom lock	\$380.00	\$392.00	\$402.00	\$414.00
ALXV70	P6 Vandlgard classroom lock	\$380.00	\$392.00	\$402.00	\$414.00
ALX80	P6 Storeroom lock	\$380.00	\$392.00	\$402.00	\$414.00
ALXV80	P6 Vandlgard storeroom lock	\$380.00	\$392.00	\$402.00	\$414.00

<sup>Ⓜ</sup> Extended lead time





**COMPLETE LOCKS** CYLINDER ADJUSTMENTS

Keyed locks on the previous page are priced including the P6 cylinder with open keyway. Provided below are pricing adjustments based on other available cylinder types. For Primus and Primus XP cylinders, order lock less cylinder and order the Primus or Primus XP cylinder separately.

For complete details on cylinders, tailpieces, keying and keys, including cylinders sold separate, see Schlage Commercial price book.

<b>CYLINDER ADJUSTMENTS</b>		
Restricted keyways include: Everest 29 R and T keyways, Everest B and D keyways and Classic (Reverse/Quad/Numbered) keyways		
<b>Description</b>	<b>Specify</b>	<b>Price adjustment</b>
Conventional 6-pin cylinder	P6	No charge
Conventional 6-pin cylinder, keyed 5	P	No charge
Less conventional cylinder	L	-\$94.00
FSIC (Full size interchangeable core)	R	\$46.00
Less FSIC	J	-\$60.00
SFIC (Small format interchangeable core) 7-pin	G	\$0.00
Refundable Construction SFIC (requires 50-231 handling charge per cylinder)	H	\$30.00
Disposable Construction SFIC	BDC	-\$60.00
Less SFIC	B	-\$60.00
Handling charge for construction core (assessed per cylinder, non-refundable)	50-231	\$15.20

Note: Construction cores (T and H) have an additional handling charge 50-231.

**COMPLETE LOCKS** LATCHES

Specify on order only if requesting an option other than the default.

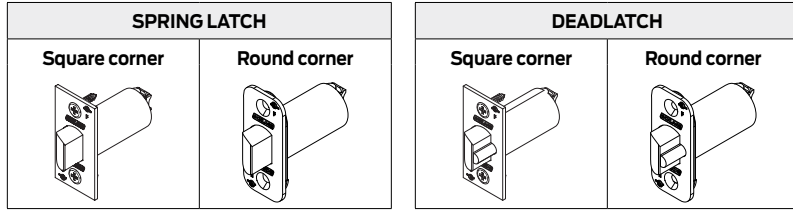

LATCHES						
SPRING LATCH						
Default	Faceplate description	Backset	Function	Housing dia.	Specify	Price adjustment
▪	1-1/8" x 2-1/4" Square corner	2-3/4"	Restoring	7/8"	47267038	No charge
	1" x 2-1/4" Square corner	2-3/4"	Restoring	7/8"	47267039	
	1" x 2-1/4" Round corner	2-3/4"	Restoring	7/8"	47267041	
	1" x 2-1/4" Square corner	2-3/8"	Restoring	7/8"	47267048	
	1" x 2-1/4" Round corner	2-3/8"	Restoring	7/8"	47267050	
DEADLATCH						
Default	Faceplate description	Backset	Function	Housing dia.	Specify	Price adjustment
▪	1-1/8" x 2-1/4" Square corner	2-3/4"	Non-restoring	7/8"	47267042	No charge
	1" x 2-1/4" Square corner	2-3/4"	Non-restoring	7/8"	47267043	
	1" x 2-1/4" Round corner	2-3/4"	Non-restoring	7/8"	47267045	
	1" x 2-1/4" Square corner	2-3/8"	Non-restoring	7/8"	47267052	
	1" x 2-1/4" Round corner	2-3/8"	Non-restoring	7/8"	47267054	

**COMPLETE LOCKS** STRIKES

Specify on order only if requesting an option other than the default.

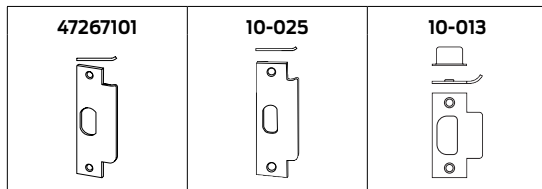

STRIKES					
Default	Description	Lip length	Specify		Price adjustment
			Strike part number	Lip length	
▪	ANSI, no box, 1-1/4" x 4-7/8"	1-3/16"	47267101	-	No charge
	ANSI, no box, 1-1/4" x 4-7/8"	1-3/8"	10-025	LIP1-3/8	\$46.70
	ANSI, no box, 1-1/4" x 4-7/8"	1-1/2"	10-025	LIP1-1/2	\$46.70
	Square corner, T-strike, dust box, 1-1/8" x 2-3/4"	1-1/8"	10-013	LIP1-1/8	No charge
	Square corner, T-strike, dust box, 1-1/8" x 2-3/4"	1-1/2"	10-013	LIP1-1/2	
	Square corner, full lip, no box, 1-5/8" x 2-1/4"	1-1/8"	10-026	-	-\$11.80
	1/4" Radius round corner, full lip, no box, 1-5/8" x 2-1/4"	1-1/8"	10-027	-	-\$11.80
	Box for ANSI strike (Must be specified)	-	K510-066	-	No charge

## MA SERIES ■ OVERVIEW

### Product identification

**MA521 . P . AG . 626**

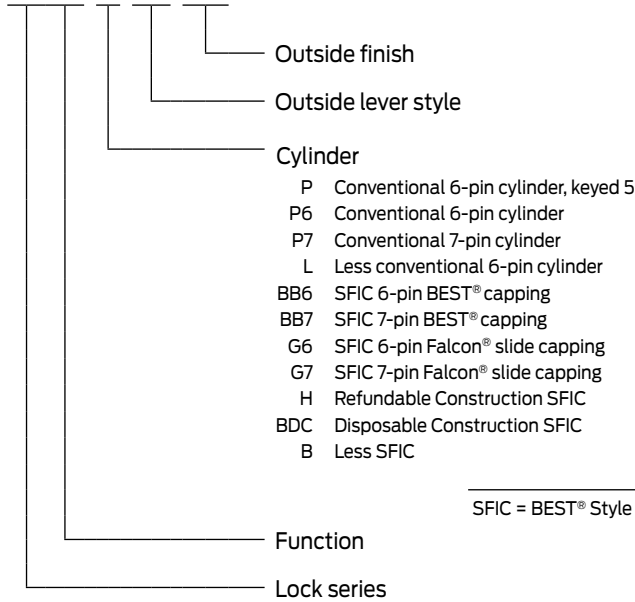

### Finish codes and descriptions

BHMA code		Description
619	(US 15)	Satin Nickel
622	(US 19)	Matte Black
625	(US 26)	Bright Chrome
626	(US 26D)	Satin Chrome
630	(US 32D)	Satin Stainless Steel
643e	(US 11)	Aged Bronze

### Standard features



Certifications	ANSI A156.13, Series 1000, Grade 1 Operation and Security, UL Listed for 3-Hour fire door. With SFIC Interchangeable Core Cylinders: Grade 3 Security.
Case size	4-5/32" x 6"
Armor front	1-1/4" x 8"
Deadbolt	1" throw stainless steel
Latch bolt	2 piece stainless steel anti-friction bolt 3/4" projection
Strike	1-1/4" x 4-7/8", ANSI, square corner, with dust box
Backset	2-3/4"
Cylinder	6-pin solid brass, keyed 5-pin, Falcon G keyway, keyed different (KD)
Door range	1-3/4"–1-7/8" standard
Keys	Two, nickel silver cut keys per lock, Falcon G keyway

### FUNCTIONS

ANSI/BHMA A156.13, Series 1000, Grade 1 Operation and Security, UL Listed for 3-Hour fire door

#### MORTISE LOCKS NON-KEYED

FALCON ANSI

##### MA101 F01

##### Passage/closet latchset

Latch bolt retracted by knob/lever from either side at all times. Inside knob/lever is always free for immediate egress.

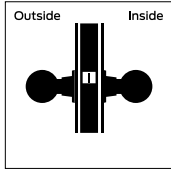

##### MA301 F02

##### Privacy lock

Latch bolt operated by knobs/levers either side, dead bolt operated by turn from inside or by emergency release outside. Available with messaging indicator. Please specify.

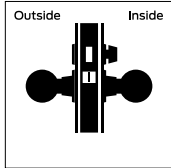

#### MORTISE LOCKS KEYED

FALCON ANSI

##### MA441 F32

##### Classroom security lock

Latch bolt operated by knob/lever from either side except when outside knob/lever is locked from inside or outside by key. When outside knob/lever is locked, latch bolt is retracted by key from inside or outside or by operating inside knob/lever. Auxiliary dead latch. Inside knob/lever is always free for immediate egress. Available with messaging indicator. Please specify.

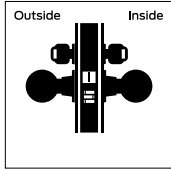

##### MA521 F04

##### Entry/office lock

Latch bolt operated by knob/lever from either side except when outside knob/lever is made inoperative by buttons in face. When outside knob/lever is locked, latch bolt is retracted by key from outside or by operating inside knob/lever. Auxiliary dead latch. Inside knob/lever is always free for immediate egress.

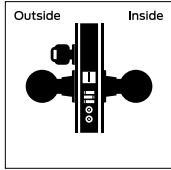

##### MA551 F06

##### Holdback lock

(Last date to order: September 30, 2024)

Latch bolt operated by lever from either side except when outside lever is locked from outside by key. Latch bolt can be locked in a retracted position by key. When outside lever is locked, latch bolt is retracted by key from outside or by operating inside lever unless latch bolt has been locked in a retracted position. Auxiliary dead latch. Inside knob/lever is always free for immediate egress.

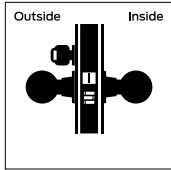

Note: Chassis is handed.

#### MORTISE LOCKS KEYED

FALCON ANSI

##### MA561 F05

##### Classroom lock

Latch bolt operated by knob/lever from either side except when outside knob/lever is locked by key. When outside knob/lever is locked, Latch bolt is retracted by key from outside or by operating inside knob/lever. Auxiliary latch deadlocks Latch bolt when door is closed. Inside knob/lever is always free for immediate egress.

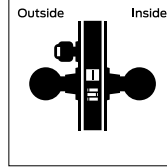

##### MA581 F07

##### Storeroom lock

Latch bolt operated by key from outside or by operating inside knob/lever. Outside knob/lever is always inoperative. Auxiliary dead latch. Inside knob/lever is always free for immediate egress.

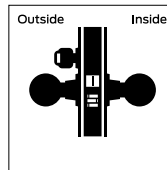

#### MORTISE LOCKS KEYED WITH DEADBOLT

FALCON ANSI

##### MA531 F20

##### Apartment corridor door lock

Latch bolt operated by knob/lever from either side, except when outside knob/lever is made inoperative by buttons in face. Dead bolt operated by key outside or turn inside. Key outside operates both bolts. Operating inside knob/lever retracts both bolts and outside remains locked. Latch bolt is deadlocked when outside knob/lever is made inoperative or when the dead bolt is projected. When dead bolt is retracted, knob/lever is unlocked by buttons in face. Inside knob/lever is always free for immediate egress.

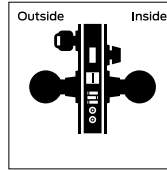

##### MA571 F13

##### Dormitory or exit lock

Latch bolt operated by knob/lever from either side. Dead bolt projected by key from outside and Turn from inside. Operating inside knob/lever retracts both bolts and unlocks outside. Inside knob/lever is always free for immediate egress. Available with messaging indicator. Please specify.

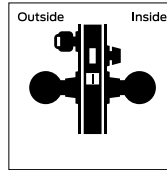

RESIDENTIAL ELECTRONIC  
RESIDENTIAL MECHANICAL  
COMMERCIAL WIRELESS ELECTRONIC  
COMMERCIAL MECHANICAL/ELECTRIFIED

## LEVER DESIGNS

### AVALON



AG Avalon-Gala  
6AG Avalon-Gala Abrasive  
8AG Avalon-Gala Knurled

AN Avalon-Napa  
6AN Avalon-Napa Abrasive  
8AN Avalon-Napa Knurled

### BOARDWALK

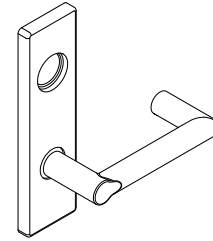
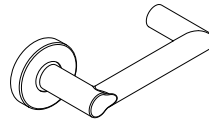

BOG Boardwalk-Gala

BON Boardwalk-Napa

### BROADWAY

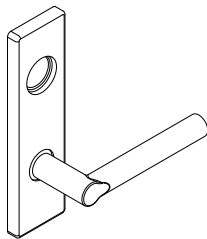
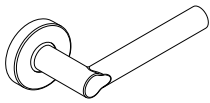

BRG Broadway-Gala

BRN Broadway-Napa

### DANE

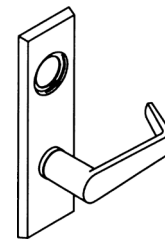
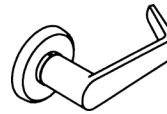

DG Dane-Gala  
6DG Dane-Gala Abrasive  
8DG Dane-Gala Knurled

DN Dane-Napa  
6DN Dane-Napa Abrasive  
8DN Dane-Napa Knurled

### LATITUDE

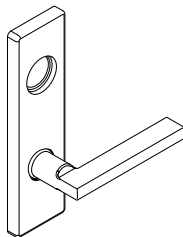
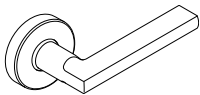

LTG Latitude-Gala

LTN Latitude-Napa

### LONGITUDE

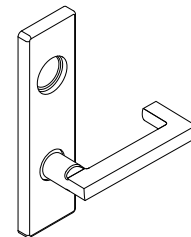
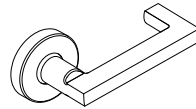

LGG Longitude-Gala

LGN Longitude-Napa

### QUANTUM

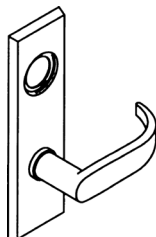
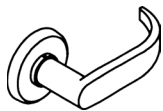

QG Quantum-Gala  
6QG Quantum-Gala Abrasive  
8QG Quantum-Gala Knurled

QN Quantum-Napa  
6QN Quantum-Napa Abrasive  
8QN Quantum-Napa Knurled

619	622	625	626	630	643E
US15	US19	US26	US26D	US32D	US11

COMPLETE LOCKS			LEVER STYLES (ROSE)		LEVER STYLES (ESCUTCHEON)	
Split finishes and designs will be priced at the highest list price of the design and/or finish.  Keyed function pricing based on cylinder with open Falcon G keyway. See page 118 for additional cylinder and keyway options.  🛠 Denotes a product that requires handing to be specified.			AG	LTG	AN	LTN
			BOG	LGG	BON	LGN
			BRG	QG	BRN	QN
			DG		DN	
FINISHES						
SERIES + FUNCTION CYL DESCRIPTION			626, 643e	619, 622, 625, 630 <sup>1</sup>	626, 643e	619, 622, 625, 630 <sup>1</sup>
NON-KEYED FUNCTIONS			ROSE TRIM		ESCUTCHEON TRIM	
MA101		Passage/closet latchset	\$624.00	\$636.00	\$653.00	\$665.00
MA301		Privacy lock	\$718.00	\$730.00	\$747.00	\$759.00
KEYED, SINGLE CYLINDER, NON-DEADBOLT FUNCTIONS			ROSE TRIM		ESCUTCHEON TRIM	
MA521	P	Entry/office lock	\$799.00	\$811.00	\$828.00	\$840.00
MA561	P	Classroom lock	\$799.00	\$811.00	\$828.00	\$840.00
MA581	P	Storeroom lock	\$799.00	\$811.00	\$828.00	\$840.00
KEYED, SINGLE CYLINDER, DEADBOLT FUNCTIONS			ROSE TRIM		ESCUTCHEON TRIM	
MA531	P	Apartment corridor door lock	\$824.00	\$836.00	\$853.00	\$865.00
MA571	P	Dormitory or exit lock	\$824.00	\$836.00	\$853.00	\$865.00
KEYED, DOUBLE CYLINDER FUNCTIONS			ROSE TRIM		ESCUTCHEON TRIM	
MA441 <sup>2</sup>	P	Classroom security lock	\$879.00	\$891.00	\$908.00	\$920.00

1. Boardwalk, Broadway, Latitude, and Longitude levers not available in 630 finish.
2. Caution: Double cylinder locks on residences and any door in any structure which is used for egress are a life safety hazard in times of emergency and their use is not recommended. Installation should be in accordance with existing codes only.
3. Power supply PS902 will be sufficient to operate an individual lock for multiple lock installation. See Power Supply section on page 61.
4. Specify 12 or 24VDC for MA851 and MA881 functions. Default is 12V.

## T SERIES ■ OVERVIEW

### Product identification

**T501 . P . DAN . 626**

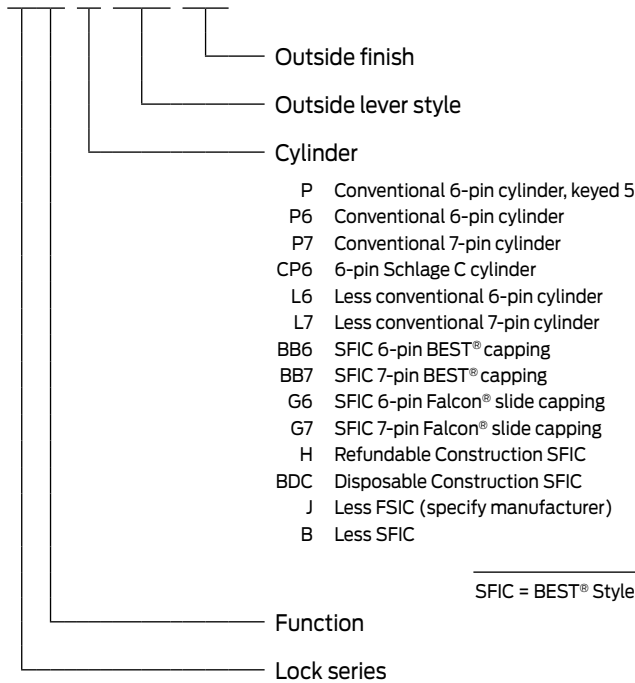

### Finish codes and descriptions

BHMA code		Description
619	(US 15)	Satin Nickel
622	(US 19)	Matte Black
625	(US 26)	Bright Chrome
626	(US 26D)	Satin Chrome
643e	(US 11)	Aged Bronze

### Standard features



Certification	ANSI A156.2, Series 4000, Grade 1, UL Listed for 3-Hour fire door
Latch	1-1/8" x 2-1/4", square corner faceplate, 1" housing diameter, 1/2" throw
Strike	1-1/4" x 4-7/8", ANSI, square corner, no box
Backset	2-3/4"
Cylinder	6-pin, solid brass, keyed 5-pin, Falcon G keyway, keyed different (KD)
Door range	1-3/4"–2-1/8" standard
Keys	Two, nickel silver cut keys per lock, Falcon G keyway

### FUNCTIONS

ANSI A156.2 Series 4000 Grade 1 key-in-lever locks

#### NON-KEYED LOCKS

FALCON ANSI

**T101 F75**

#### Passage/closet latchset

Latch bolt by levers at all times.

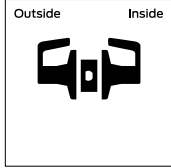

**T301 F76**

#### Privacy lock

Latch bolt by levers. Outside lever locked by push button in inside lever. Rotating inside lever or closing door releases push button. Emergency release in outside lever unlocks door.

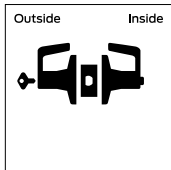

#### NON-KEYED DUMMY

FALCON ANSI

**T12**

#### Dummy trim

Single trim, surface-mounted rigid lever.

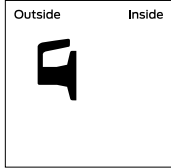

#### KEYED LOCKS

FALCON ANSI

**T351**

#### Closet lock

Deadlocking latch bolt by turn knob inside or lever outside except when outside lever is locked by key.

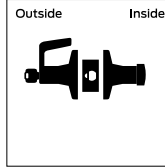

**T381 F88**

#### Classroom security lock

Latch bolt operated by lever from either side except when key from inside lever locks outside lever. When outside lever is locked, Latch bolt retracted by key in outside lever or by turning inside lever.

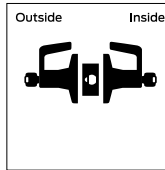

**T511 F109**

#### Entry/office lock

Turn/push button locking. Pushing and turning button locks outside lever requiring use of key until button is manually unlocked. Push button locking. Pushing button locks outside lever until unlocked by key or by rotating inside lever. Inside lever always free. Deadlocking latch bolt.

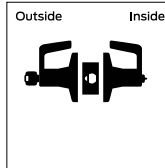

**T561 F84**

#### Classroom lock

Deadlocking latch bolt by levers. Outside lever is locked by key in outside lever. Inside lever is always free.

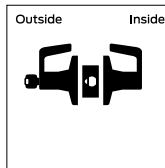

**T581 F86**

#### Storeroom lock

Deadlocking latch bolt by lever inside or key outside. Outside lever is inoperable. Inside lever always free.

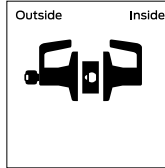



## LEVER DESIGNS

---

### AVALON

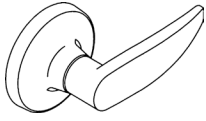

AVA Avalon  
6AV Avalon Abrasive

### BROADWAY

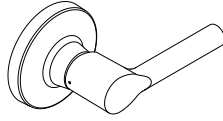

BRW Broadway

### DANE

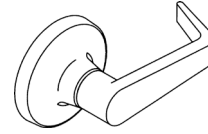

DAN Dane  
6DA Dane Abrasive

### LATITUDE

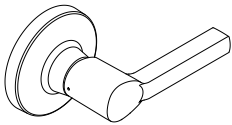

LAT Latitude

### QUANTUM

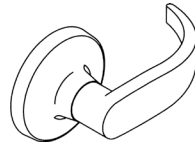

QUA Quantum  
6QU Quantum Abrasive

619	622	625	626	643E
US15	US19	US26	US26D	US11

COMPLETE LOCKS			LEVER STYLES	
Split finishes and designs will be priced at the highest list price of the design and/or finish.  Keyed function pricing based on cylinder with open Falcon G keyway. See page 118 for additional cylinder and keyway options.			AVA	AVA
			BRW	BRW
<b>SERIES +</b> <b>FUNCTION      CYL      DESCRIPTION</b>			<b>FINISHES</b>	
			626, 643e	619, 622, 625
<b>NON-KEYED FUNCTIONS</b>				
T101		Passage/closet latchset	\$437.00	\$449.00
T301		Privacy lock	\$549.00	\$561.00
<b>NON-KEYED DUMMY FUNCTIONS</b>				
T12		Dummy trim	\$194.00	\$200.00
<b>KEYED, SINGLE CYLINDER FUNCTIONS</b>				
T351	P	Closet lock	\$612.00	\$624.00
T511	P	Entry/office lock	\$612.00	\$624.00
T561	P	Classroom lock	\$612.00	\$624.00
T581	P	Storeroom lock	\$612.00	\$624.00
<b>KEYED, DOUBLE CYLINDER FUNCTIONS</b>				
T381 <sup>2</sup>	P	Classroom security lock	\$715.00	\$727.00

1. 24V is standard. Power supply PS902 will be sufficient to operate an individual lock for multiple lock installation. See Power Supply section on page 61.
2. Caution: Double cylinder locks on residences and any door in any structure which is used for egress are a life safety hazard in times of emergency and their use is not recommended. Installation should be in accordance with existing codes only.

RESIDENTIAL ELECTRONIC  
 RESIDENTIAL MECHANICAL  
 COMMERCIAL WIRELESS ELECTRONIC  
 COMMERCIAL MECHANICAL/ELECTRIFIED

## W SERIES ■ OVERVIEW

### Product identification

**W501 . P . DAN . 626**

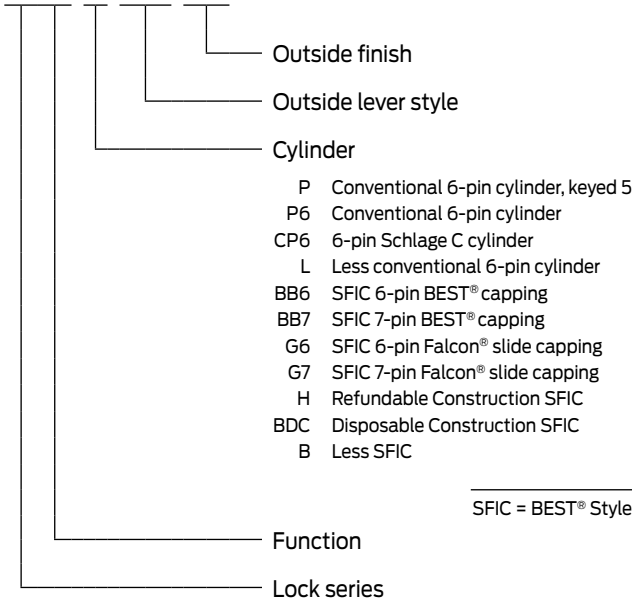

### Finish codes and descriptions

BHMA code		Description
619	(US 15)	Satin Nickel
622	(US 19)	Matte Black
625	(US 26)	Bright Chrome
626	(US 26D)	Satin Chrome
643e	(US 11)	Aged Bronze

### Standard features



Certification	ANSI A156.2, Series 4000, Grade 2, UL Listed for 3-Hour fire door
Latch	1-1/8" x 2-1/4", square corner faceplate, 1" housing diameter, 1/2" throw
Strike	1-1/4" x 4-7/8", ANSI, square corner, no box
Backset	2-3/4"
Cylinder	6-pin, solid brass, keyed 5-pin, Falcon G keyway, keyed different (KD)
Door range	1-3/8"–1-3/4" standard
Keys	Two, nickel silver cut keys per lock, Falcon G keyway

### FUNCTIONS

ANSI A156.2 Series 4000 Grade 2 key-in-lever locks

#### NON-KEYED LOCKS

FALCON ANSI

**W101 F75**

#### Passage latchset

Latch bolt by levers/knobs at all times.

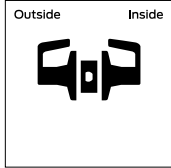

**W161 F111**

#### Communicating/exit latch

Deadlocking latch bolt by inside lever. Non-removable blank plate outside. Function not available in knob designs.

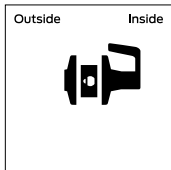

**W201 F77**

#### Patio lock

Deadlocking latch bolt by levers. Outside lever is locked by push button from inside. Rotating inside lever or closing door releases button and unlocks outside lever. Function not available for small rose option or knob designs.

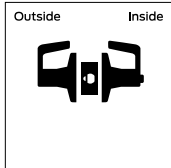

**W301 F76**

#### Privacy lock

Latch bolt by levers/knobs. Outside lever/knob is locked by push button in inside lever/knob. Rotating inside lever/knob or closing door release push button and frees outside lever/knob. Inside lever/knob is always free. Emergency release in outside lever/knob unlocks door.

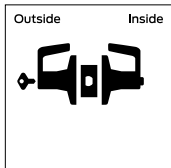

#### NON-KEYED DUMMY

FALCON ANSI

**W12**

#### Single dummy

Single dummy trim available with lever/knob.

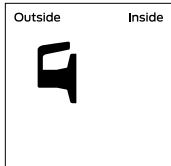

**W18**

#### Double dummy

Double dummy trim available with levers.

Image not available

#### KEYED LOCKS

FALCON ANSI

**W501 F82**

#### Entry lock

Push button locking. Button on the inside locks outside lever/knob until unlocked by key or by rotating inside lever/knob. Inside lever/knob always free. Deadlocking latch bolt. Function not available for small rose option.

Function note: This lock will stay locked when the door is closed. If you want your door to unlock when it closes, please purchase the 571 function.

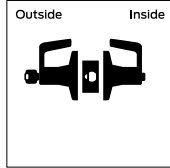

**W511 F109**

#### Entry/office lock

Deadlocking latch bolt by levers/knobs. Turn/push button locking. Pushing and turning button locks outside lever/knob, requiring use of a key for unlocking the door until button is manually unlocked. Pushing button locks outside lever/knob until unlocked by key or by rotating inside lever/knob. Inside lever/knob is always free.

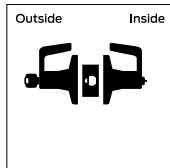

**W561 F84**

#### Classroom lock

Deadlocking latch bolt by levers/knobs. Outside lever/knob is locked by key in outside lever/knob. Inside lever/knob is always free.

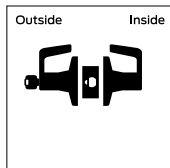

**W571 F90**

#### Corridor lock

Deadlocking latch bolt. Push button locking only. Button on the inside locks outside lever/knob until unlocked by key or by rotating inside lever/knob. Closing the door releases button. Inside lever/knob always free. Function not available for small rose option.

Function note: This lock will unlock when the door is closed. If you want your door to remain locked when it closes, please purchase the 501 function.

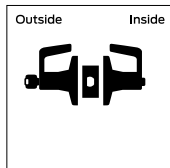

**W581 F86**

#### Storeroom lock

Deadlocking latch bolt by lever/knob inside or key outside. Outside lever/knob is always locked. Inside lever/knob is always free.

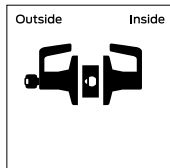

**W711**

#### Apartment entrance lock

Deadlocking latch bolt by levers/knob. Turn/push button locking. Pushing and turning button locks outside lever/knob, requiring use of a key for unlocking the door until button is manually unlocked. Pushing button locks outside lever/knob until unlocked by key, by rotating inside lever/knob, or by closing door. Inside lever/knob is always free. Function not available for small rose option.

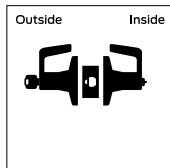

## LEVER/ROSE DESIGNS

### AVALON

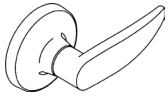

AVA Avalon

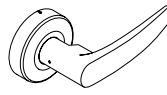

SRA Small Rose Avalon

### BROADWAY

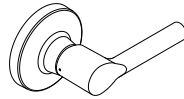

BRW Broadway

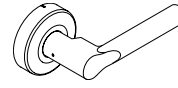

SRBR Small Rose Broadway

### DANE

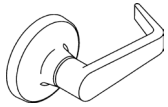

DAN Dane  
6DA Dane Abrasive

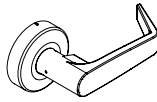

SRD Small Rose Dane  
6SD Small Rose Dane  
Abrasive

### LATITUDE

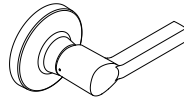

LAT Latitude

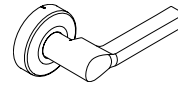

SRLA Small Rose Latitude

### QUANTUM

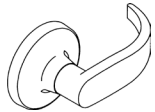

QUA Quantum  
6QU Quantum Abrasive

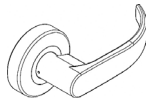

SRQ Small Rose Quantum  
6SQ Small Rose Quantum  
Abrasive

## KNOB/ROSE DESIGNS<sup>1</sup>

### ELITE

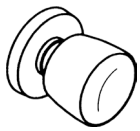

ELI Elite

### HANA

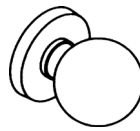

HAN Hana

<sup>1</sup> Not available with a small rose. Small rose option is for levers only.

619	622	625	626	643E
US15	US19	US26	US26D	US11

COMPLETE LOCKS			LEVER STYLES	
 <p>STANDARD ROSE</p> <p>Split finishes and designs will be priced at the highest list price of the design and/or finish.</p> <p>Keyed function pricing based on cylinder with open Falcon G keyway. See page 118 for additional cylinder and keyway options.</p>			AVA BRW DAN LAT QUA	AVA BRW DAN LAT QUA
			FINISHES	
<p><b>SERIES + FUNCTION</b></p> <p><b>CYL DESCRIPTION</b></p>			626, 643e	619, 622, 625
NON-KEYED FUNCTIONS			3-3/8" STANDARD ROSE (85.7MM)	
W101		Passage latchset	\$147.00	\$159.00
W161		Communicating/exit latch	\$148.00	\$160.00
W201		Patio lock	\$148.00	\$160.00
W301		Privacy lock	\$148.00	\$160.00
NON-KEYED DUMMY FUNCTIONS			3-3/8" STANDARD ROSE (85.7MM)	
W12		Single dummy trim	\$88.00	\$94.00
W18		Double dummy trim (not available with AVA, LAT, LON, BRW, and BRK levers; not available in 619, 622 and 643e finishes)	\$172.00	\$184.00
KEYED, SINGLE CYLINDER FUNCTIONS			3-3/8" STANDARD ROSE (85.7MM)	
W501	P	Entry lock	\$164.00	\$176.00
W511	P	Entry/office lock	\$164.00	\$176.00
W561	P	Classroom lock	\$164.00	\$176.00
W571	P	Corridor lock	\$164.00	\$176.00
W581	P	Storeroom lock	\$164.00	\$176.00
W711	P	Apartment entrance lock	\$164.00	\$176.00

RESIDENTIAL ELECTRONIC

RESIDENTIAL MECHANICAL

COMMERCIAL WIRELESS ELECTRONIC

COMMERCIAL MECHANICAL/ELECTRIFIED

619	622	625	626	643E
US15	US19	US26	US26D	US11

COMPLETE LOCKS			LEVER STYLES	
 <p>SMALL ROSE</p> <p>Split finishes and designs will be priced at the highest list price of the design and/or finish.</p> <p>Keyed function pricing based on cylinder with open Falcon G keyway. See page 118 for additional cylinder and keyway options.</p> <p><b>SERIES + FUNCTION</b>      <b>CYL</b>    <b>DESCRIPTION</b></p>			<p>SRA</p> <p>SRBR</p> <p>SRD</p> <p>SRLA</p> <p>SRQ</p>	
			<p>SRA</p> <p>SRBR</p> <p>SRD</p> <p>SRLA</p> <p>SRQ</p>	
			FINISHES	
			626, 643e	619, 622, 625
NON-KEYED FUNCTIONS			2-9/16" SMALL ROSE (65MM)	
W101		Passage latchset	\$158.00	\$170.00
W161		Communicating/exit latch	\$164.00	\$176.00
W301		Privacy lock	\$164.00	\$176.00
NON-KEYED DUMMY FUNCTIONS			2-9/16" SMALL ROSE (65MM)	
W12		Single dummy trim	\$93.00	\$99.00
KEYED, SINGLE CYLINDER FUNCTIONS			2-9/16" SMALL ROSE (65MM)	
W511	P	Entry/office lock	\$194.00	\$206.00
W561	P	Classroom lock	\$194.00	\$206.00
W581	P	Storeroom lock	\$194.00	\$206.00

COMPLETE LOCKS			KNOB STYLES	
 <p>KNOBS</p> <p>Not available with small rose.</p> <p>Split finishes and designs will be priced at the highest list price of the design and/or finish.</p> <p>Keyed function pricing based on cylinder with open Falcon G keyway. See page 118 for additional cylinder and keyway options.</p> <p><b>SERIES + FUNCTION</b>      <b>CYL</b>    <b>DESCRIPTION</b></p>			<p>ELI</p> <p>HAN</p>	
			FINISHES	
			626	605, 606, 613, 625
NON-KEYED FUNCTIONS				
W101		Passage latchset	\$77.00	\$89.00
W301		Privacy lock	\$78.00	\$90.00
NON-KEYED DUMMY FUNCTIONS				
W12		Single dummy trim	\$58.00	\$64.00
KEYED, SINGLE CYLINDER FUNCTIONS				
W501	P	Entry lock	\$94.00	\$106.00
W511	P	Entry/office lock	\$94.00	\$106.00
W561	P	Classroom lock	\$94.00	\$106.00
W571	P	Corridor lock	\$94.00	\$106.00
W581	P	Storeroom lock	\$94.00	\$106.00
W711	P	Apartment entrance lock	\$94.00	\$106.00

## D200 SERIES ■ OVERVIEW

### Product identification

**D211F . P . 626**

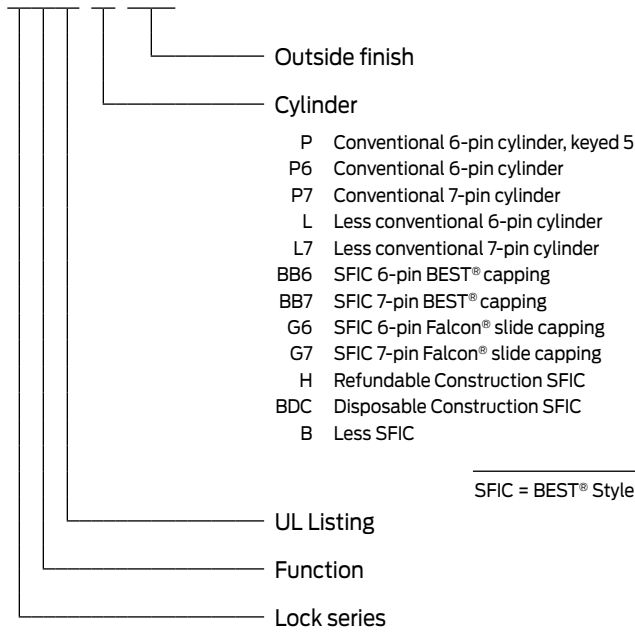

### Finish codes and descriptions

BHMA code		Description
619	(US 15)	Satin Nickel
622	(US 19)	Matte Black
625	(US 26)	Bright Chrome
626	(US 26D)	Satin Chrome
643e	(US 11)	Aged Bronze

### Standard features



Certification	BHMA - ANSI A156.5, 2001, Grade 2 (except D261M) auxiliary lock, Available UL Listed for 3-Hour fire door
Deadbolt	1-1/8" x 2-1/4", square corner faceplate, 1" housing diameter, 1" throw
Strike	1-1/8" x 2-3/4", lipless, with box
Backset	2-3/8" and 2-3/4" adjustable
Cylinder	6-pin, solid brass, keyed 5-pin, Falcon G keyway, keyed different (KD)
Door range	1-3/8"–2-1/4" standard cylinder or thumbturn only; 1-5/8"–2" interchangeable core cylinder
Keys	Two, nickel silver cut keys per lock, Falcon G keyway
Reinforcement	Metal dust box reinforcer with three 3" screws
Trim ring	1" Wrought brass or bronze, reinforced with security insert





## FUNCTIONS

BHMA / ANSI A156.5, 2001, Grade 2 bored deadbolt locks

### KEYLESS

FALCON ANSI

**D261 E0192**

#### Thumbturn, inside only

Deadbolt thrown or retracted by turn unit only. No outside trim. Bolt automatically deadlocks when fully thrown.

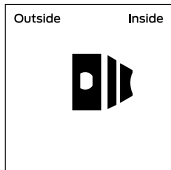

**D261M E0112**

#### Thumbturn, inside x rose

Deadbolt thrown or retracted by turn unit only. Outside blank rose. Bolt automatically deadlocks when fully thrown.

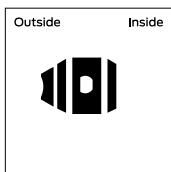

**D271**

#### Thumbturn x occupancy indicator

Deadbolt thrown or retracted by turn unit only. Occupancy indicator on outside (reads either in use or vacant with color coding). Bolt automatically deadlocks when fully thrown.

Note: This function is not UL listed.

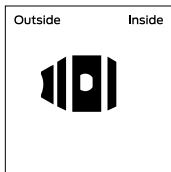

### KEYED, SINGLE CYLINDER

FALCON ANSI

**D211P E0172**

#### Classroom function

Deadbolt thrown or retracted by key from outside. Inside turn will only retract bolt. Bolt automatically deadlocks when fully thrown.

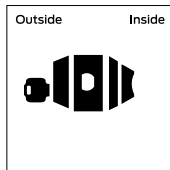

**D241P E0152**

#### Single cylinder x turn

Deadbolt thrown or retracted by key or by turn. Bolt automatically deadlocks when fully thrown.

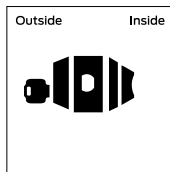

## DEADLATCH DESIGN

### Outside cylinder trim

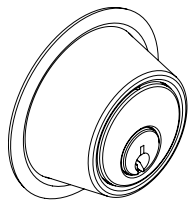

### Inside cylinder trim

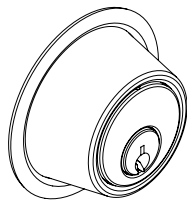

### Rose & Turn

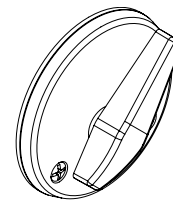

619	622	625	626	643E
US15	US19	US26	US26D	US11

COMPLETE LOCKS			FINISHES	
<p>Split finishes and designs will be priced at the highest list price of the design and/or finish.</p> <p>Keyed function pricing based on cylinder with open Falcon G keyway. See next page for additional cylinder and keyway options.</p>			626 643e	613 619 622 625
SERIES + FUNCTION	CYL	DESCRIPTION		
KEYLESS				
D261		Thumbturn, inside only	\$80.00	\$86.00
D261M		Thumbturn, inside x rose	\$80.00	\$86.00
D271 <sup>1</sup>		Thumbturn x occupancy indicator	\$81.00	\$87.00
KEYED, SINGLE CYLINDER				
D211	P	Single cylinder x rose	\$108.00	\$114.00
D241	P	Single cylinder x turn	\$104.00	\$110.00

1. D271 Occupancy Indicator deadbolt is shipped with emergency key (61-509) and instructions.
2. 'F' Suffix must be added for UL product.

## H2 SERIES ■ OVERVIEW

### Product identification

**H2101 . P6 . AVA . 626**

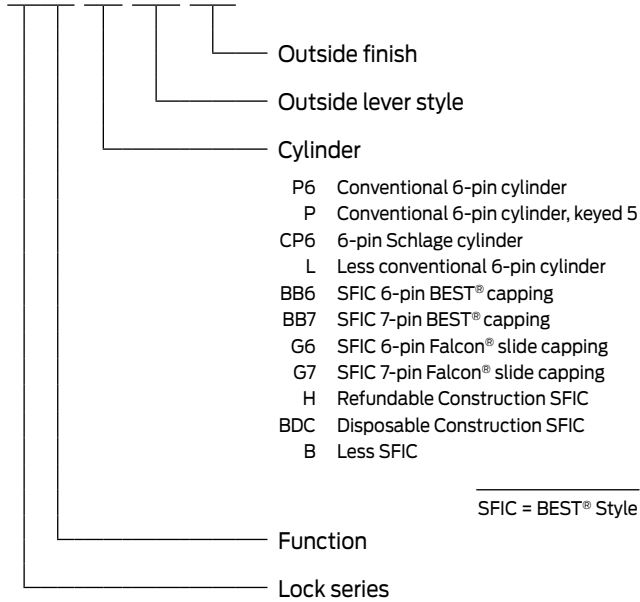

### Finish codes and descriptions

BHMA code		Description
619	(US 15)	Satin Nickel
622	(US 19)	Matte Black
625	(US 26)	Bright Chrome
626	(US 26D)	Satin Chrome
643e	(US 11)	Aged Bronze

### Standard features



Certification	ANSI/BHMA Certified A156.12-2013, Grade 2 UL listed for 3-hour fire door with SFIC interchangeable core cylinders: Grade 3 Security
Deadbolt	1 x 2-1/4", dual option faceplate, (square corner standard, round corner included in package), 1" housing diameter, 1" throw
Latch	1" x 2-1/4" dual option faceplate (square corner standard, round corner included in package). 1" edge bore required.
Strike	1-1/8" x 2-3/4", square corner (deadbolt) and 1-5/8" x 2-1/4", square corner, T-strike, box, 1-1/8" x 2-3/4" (deadlatch)
Backset	Adjustable backset, fits 2-3/8" or 2-3/4"
Cylinder	6-pin, solid brass, keyed 6-pin, Falcon G keyway, keyed different (KD)
Door range	1-3/4"–2" standard (1-3/8" available, must be specified)
Keys	Nickel silver cut keys 6-pin, G keyway
Center-to-center	Fits 4" or 5-1/2" (factory default) center-to-center door preps

## FUNCTIONS

ANSI/BHMA Certified A156.12-2013, Grade 2 Bored Deadbolt Locks

### DEADBOLT SINGLE CYLINDER

FALCON ANSI

**H2101 F95**

#### Entrance lock

Deadbolt operated by key from outside or by turn unit from inside. Bolt automatically deadlocks when fully thrown. Latch retracted by lever from either side. Turning inside lever retracts deadbolt and latch simultaneously for immediate exit.

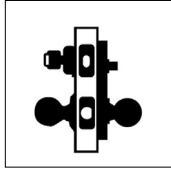

### NO CYLINDER (INTERIOR LOCKING ONLY)

FALCON ANSI

**H2171**

#### Public restroom lock with occupancy indicator

Latch bolt retracted by lever from either side. Deadbolt thrown or retracted by turn inside or retracted by emergency key outside. Rotating turn from inside extends deadbolt and changes visual message on outside from vacant to occupied. Inside lever simultaneously retracts deadbolt and latch.

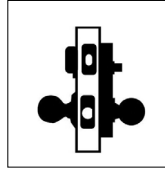

## LEVER DESIGNS

Note: Handing must be specified for split finishes and/or designs. Right Hand is standard.

### AVALON (AVA)



### BOARDWALK (BRK)

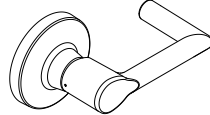

### BROADWAY (BRW)

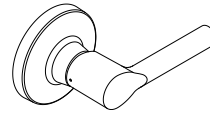

### DANE (DAN)

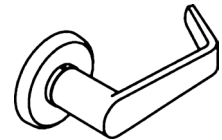

### LATITUDE (LAT)

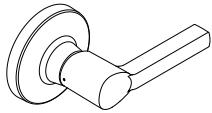

### LONGITUDE (LON)

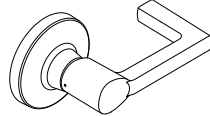

### QUANTUM (QUA)

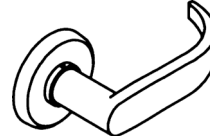

## ESCUTCHEON DESIGNS

### PLYMOUTH (PLY)

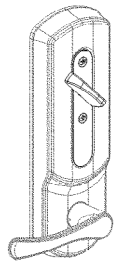

619	622	625	626	643E
US15	US19	US26	US26D	US11

COMPLETE LOCKS			LEVER STYLES	
<p>Split finishes and designs will be priced at the highest list price of the design and/or finish.</p> <p>Keyed function pricing based on P6 cylinder with open Falcon G keyway. See below for additional cylinder and keyway options.</p>			AVA	AVA
			BRK	BRK
<p><b>SERIES +</b></p> <p><b>FUNCTION      CYL    DESCRIPTION</b></p>			BRW	BRW
			DAN	DAN
<p><b>DEADBOLT SINGLE CYLINDER</b></p>			LAT	LAT
			LON	LON
<p><b>NO CYLINDER (INTERIOR LOCKING ONLY)</b></p>			QUA	QUA
			<p><b>FINISHES</b></p>	
			626, 643e	619, 622, 625
H2101	P6	Entrance lock	\$415.00	\$427.00
H2171		Public restroom with occupancy indicator	\$549.00	\$561.00

## CYLINDERS

### Finish codes and descriptions

BHMA code		Description
619	(US 15)	Satin Nickel
622	(US 19)	Matte Black
625	(US 26)	Bright Chrome
626	(US 26D)	Satin Chrome
643e	(US 11)	Aged Bronze

\* See individual products for finish availability.

### Standard features



Standard cylinder	Solid brass housings and plugs. Standard keyway is Falcon G keyway. Keyed different furnished unless otherwise specified (additional charges may apply, see page 121 for keying charges) with 2 nickel silver keys. Mortise cylinder standard lengths are 1-1/8" for conventional cylinders and 1-3/8" for small format interchangeable core housings.
SFIC	Furnished in A keyway unless otherwise specified. Combined cores are provided with 2 keys.
Restricted keyways	Falcon has a varied selection of restricted keyways for conventional and SFIC cylinders based on geographic restrictions for usage. Minimum cylinder purchase required. See your Security and Safety Consultant for more information or availability.

619	622	625	626	643E
US15	US19	US26	US26D	US11



Non-IC Products

**SOLD SEPARATE** MORTISE

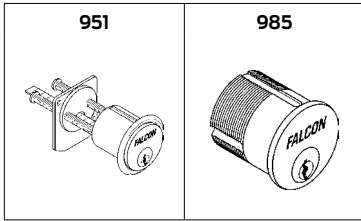

MA AND M SERIES CONVENTIONAL RIM AND MORTISE CYLINDERS					
Description	Length	Pins <sup>1</sup>	Specify	Price	
			Part number	626, 643e	619, 622
Mortise (985 not available in 625 finish)	1-1/8	5 or 6	985	\$89.00	N/A
	1-1/4	5 or 6	986	\$89.00	\$95.00
Rim cylinder (Not available in 625 finish. 622/643e finishes available August 2023)	-	5, 6, or 7	951	\$89.00	\$95.00

1. Conventional 7-pin cylinder (P7) list add \$16.80.
2. MA cam (5622-STD) provided.
3. Mortise and rim cylinders are not available in any competitor keyway, except Schlage C.
4. Conventional mortise cylinder with Schlage C keyway are available with 985, 986 and 951.

**SOLD SEPARATE** SFIC RIM AND MORTISE CORE



IC Products

- All prices are less core. To order housing with core include desired pins (ex. C987-6 for mortise cylinder with 6-pin core).
- Price of core will be added to prices listed below.

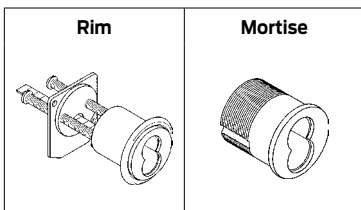

SMALL FORMAT INTERCHANGEABLE RIM AND MORTISE CORE HOUSINGS ONLY					
Description	Length	Pins	Specify	Price	
			Cat. number	626, 643e	619, 622, 625
Mortise	1-3/8"	6 or 7	C987	\$52.00	\$55.00
	1-1/2"	6 or 7	C988	\$52.00	\$55.00
Rim	N/A	6 or 7	C953	\$57.00	\$60.00

1. All mortise cylinders will be furnished with cam 5622-IC, except for MA381 function which will be supplied with 5620-IC and 5621-IC. See Falcon Price Book for additional available cams.
2. 622 finish only available as Housing. For complete assembly, order housing and core separately.
3. When ordering cylinders with construction cores, include the suffix -7 CCA or -6 CCA added to the part number. i.e. C987-6 CCA 626 for a 6-pin small format construction core included with a C987 cylinder in 626 finish.
4. For mortise cylinders, A08794-XXX tapered ring is supplied by default. If different is desired, please specify.
5. To order mortise cylinder with straight cam inverted for dogging, specify A12667-003-DOG.

605	606	613	619	622	625	626	643E
US3	US4	US10B	US15	US19	US26	US26D	US11



**SOLD SEPARATE**

### INTERCHANGEABLE CORES

- Standard cores use a single spring cover to seal pin chambers.
- With BEST® style capping, each pin chamber is sealed with its own individual cap.
- Specify core number, keyway, and finish when ordering.

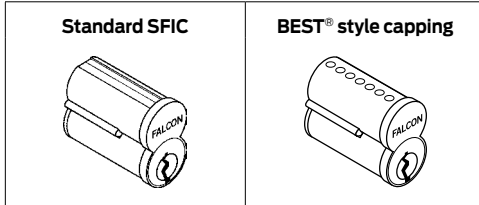

REGULAR CORE (SUFFIX KEYWAY TO NUMBER)																			
Available finishes							605	606	609	612	613 <sup>1</sup>	619	622 <sup>2</sup>	625	626	629	630	643e	
							▪	▪	N/A	N/A	▪	N/A	▪	▪	▪	N/A	N/A	N/A	
Description	Uncombined			Combined															
	6-pin	7-pin	Price	6-pin	7-pin	Price													
Standard SFIC	C646	C647	\$45.00	C606	C607	\$62.00													
BEST® style capping	CB846	CB847		CB806	CB807														
No logo	C648	C649	\$45.00	C608	C609														
No logo, BEST capping	CB848	CB849		CB808	CB809														

1. For restricted keyways add \$16.00 per core. See Falcon Price Book for restricted keyway policies.
2. For temporary construction cores and policy, see page 123.
3. For 605, 613 and 625, add \$3.00 per core. Minimum 250 pieces.
4. Keying must be specified on combined cores. (unspecified orders will default to uncombined). 0-Bitted keying option will no longer be available in SFIC.

Pricing	Uncombined cores have no pins, springs or keys. Combined core prices include master keying.
Finishes	606 and 626 standard.
Packaging	Uncombined cores are packed 20 per box.
Keyways	The "A" keyway is standard for IC products and will be supplied unless otherwise specified. A, B, C, D, DD, E, F, G, H, J, K, L, M, N, Q, R, TB and TD are equivalent to BEST® and Arrow® IC keyways of the same letter designations. All other keyways are restricted. Add \$16.00 list for all restricted keyways.
Logo	Cores and keys are supplied with the Falcon logo standard.
Optional	Combined cores supplied without logo are furnished with unembossed keys.



605	606	613	619	622	625	626	643E
US3	US4	US10B	US15	US19	US26	US26D	US11



Non-IC Products

**SOLD SEPARATE**

### CONVENTIONAL KEYS AND BLANKS

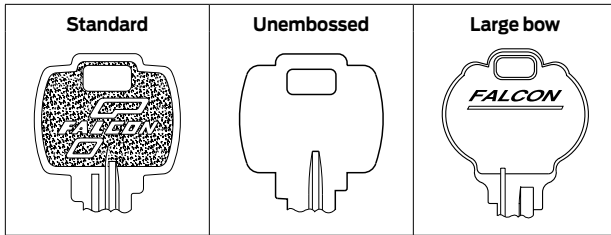

<b>KEY BLANKS</b> (Specify keyway and order in multiples of 50 except where specified)			
Description	Qty./Wt.	Specify	Price
		Part number	
Standard 5-pin	50/1	KB573	\$3.50
Standard 6-pin		KB577	
Standard 7-pin	35/1	KB581	\$4.00
Unembossed 5-pin	50/1	KB751	\$3.60
Unembossed 6-pin		KB761	
Unembossed 7-pin	35/1	KB771	\$4.10
Large bow - 5-pin	25/1	KB544	\$7.60
Large bow - 6-pin	25/1	KB590	\$7.60
6-pin Schlage C Blank	1	Q330-215	\$4.50

<b>CUT KEYS</b>		
Description	Specify	Price
	Part number	
Standard 5-pin	KB574	\$10.40
Standard 6-pin	KB578	
Standard 7-pin	KB582	
Unembossed 5-pin	KB794	
Unembossed 6-pin	KB797	
Unembossed 7-pin	KB799	
Large bow - 5-pin (When furnished with lock - 2 keys) additional per lock	KB545	\$16.90
Large bow - 5-pin	KB545	
Large bow - 6-pin (When furnished with lock - 2 keys) additional per lock	KB591	\$14.50
Large bow - 6-pin	KB591	
Schlage C - 6-pin	330055	\$10.20
Schlage Split Key 6-pin	Q330-276	\$13.50

Specify key section to key (blank) numbers.

Letter of authorization required for restricted sections; not available to stock; shipped directly to the end user.

605	606	613	619	622	625	626	643E
US3	US4	US10B	US15	US19	US26	US26D	US11

**SOLD SEPARATE**

### IC KEYS AND KEY BLANKS, DISPOSABLE CONSTRUCTION CORE

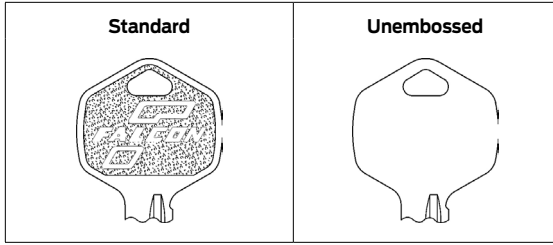

IC CORE KEY BLANKS			
Description	Standard	Plain both sides	Price
Standard	KB628	KB718	\$3.70
Stamped CONTROL	KB608	KB744	\$6.90

IC CORE CUT KEYS					
Description	Standard		Plain both sides		Price
	6-pin	7-pin	6-pin	7-pin	
Standard	KB632-1	KB632-2	KB673-1	KB673-2	\$10.40
CONTROL	KB609-1	KB609-2	KB778-1	KB778-2	\$13.40

1. Specify keyway.
2. Order standard blanks in multiples of 50.
3. Prices for key blanks and/or cut keys are for single key sections only. Key blanks 50 min. Cut keys no minimum quantity.
4. For double milled key (e.g. DE, EF, FG) add \$4.10 each to prices shown, minimum order quantity of 50 keys.
5. Triple and quadruple milled keys add \$4.60 each to price shown, minimum order quantity of 50 keys.
6. Letter of authorization required for restricted sections; not available to stock; shipped directly to the end user.

BEST® STYLE SFIC CORE KEY BLANKS			
Description	Standard	Plain both sides	Price
Standard	KB800	KB801	\$4.00

Note: KB800 and KB801 are not available in multi-milled keyways.

BEST® STYLE SFIC CORE CUT KEYS			
Description	Standard	Plain both sides	Price
Standard 6-pin	KB807-1	KB809-1	\$11.00
Stamped Control 6-pin	KB811-1	KB813-1	\$14.40
Standard 7-pin	KB807-2	KB809-2	\$16.70
Standard Control 7-pin	KB811-2	KB813-2	\$25.60

Standard key tip

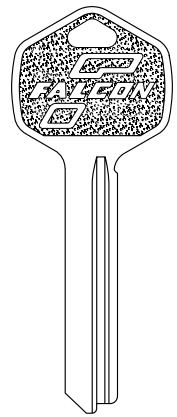

BEST® key

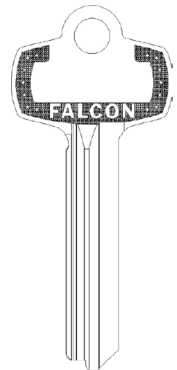

RESIDENTIAL ELECTRONIC | RESIDENTIAL MECHANICAL | COMMERCIAL WIRELESS ELECTRONIC | COMMERCIAL MECHANICAL/ELECTRIFIED

605	606	613	619	622	625	626	643E
US3	US4	US10B	US15	US19	US26	US26D	US11

**CONSTRUCTION KEYS AND KEYING CONSTRUCTION CORE PROGRAM**

**CONSTRUCTION CORE PROGRAM**

Keyed construction cores may be ordered with interchangeable core locks and cylinders. These cores may also be ordered separately. All keyed construction cores are assessed a non-refundable handling charge of \$13.60 (p/n 50-231). Standard payment terms apply.

**Features:**

- 6-pin A keyway.
- 7-pin A keyway.
- Construction cores are a flat black finish on the face. Other colors may be provided. Contact Customer Service for available colors.
- Construction cores are furnished with no keys (NCK). Cut keys must be ordered separately.
- A control key is required to install and remove construction cores. Control keys must be ordered separately.
- Construction cores may be returned for credit in working condition. Credit is issued upon receipt of cores at our factory.

A Return Material Authorization (RMA) must be issued, in order for cores to be returned.

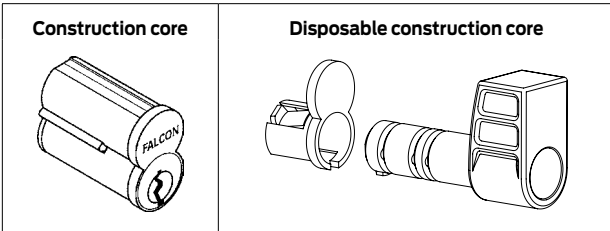

CONSTRUCTION CORE PROGRAM			
Description	Specify		Price
	Part number	Suffix	
Construction core 6-pin; Specify "H" suffix when ordering with Locks. Specify "CCA" when ordering with Mortise and Rim Cylinders.	C606CCA	See Note	\$75.60
Construction core 7-pin; Specify "H" suffix when ordering with Locks. Specify "CCA" when ordering with Mortise and Rim Cylinders.	C607CCA	See Note	\$75.60
Cut key for construction core 6-pin (order separately)	KB632-1CCA	-	\$10.40
Cut key for construction core 7-pin (order separately)	KB632-2CCA	-	\$10.40
Cut control key 6-pin (order separately)	KB609-1CCA	-	\$13.40
Cut control key 7-pin (order separately)	KB609-2CCA	-	\$13.40
Disposable construction core; Specify "BDC" suffix when ordering	1408	BDC	\$7.90
Non-refundable handling charge per core	50-231F	-	\$13.60

1. Keyed and temporary construction cores will be installed in locks and cylinders automatically unless otherwise specified on orders.
2. Construction cores for a given project are keyed alike to one of a limited number of combinations nationwide. Different Falcon projects in the same area using the same or different contractors may use the same key. Where a higher degree of security is desired, order a set of cores in 606 or 626 finish keyed alike to a random combination. Specify "KS1." Such cores are not returnable to Falcon but may be reused for other projects.
3. Temporary construction cores are an inexpensive alternative to interior keyed construction cores. This temporary is intended for use on interior door applications or where security on-site is not a concern.

**TEMPORARY CONSTRUCTION CORE PROGRAM (DISPOSABLE)**

Temporary construction cores may be ordered with interchangeable core locks and cylinders. These cores may also be ordered separately. Standard payment terms apply.

**Features:**

- Conveniently fits both 6-pin and 7-pin SFIC applications.
- No keys need to be issued.
- Disposable construction cores are not returnable.
- The disposable core is inserted in the lever or knob and is operated by a thumbturn, which retracts the latch bolt.

689	695
SP28	SP313

## VON DUPRIN EXIT DEVICES ■ 22 SERIES

### 22 SERIES

- UL listed for Panic Exit Hardware
- Devices are ANSI A156.3, 2001 Grade 1 Certified
- Two finishes available: 689 (SP28) = Aluminum Paint; 695 (SP313) = Dark Bronze Paint

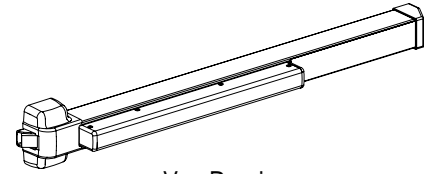

Von Duprin  
22 Series

### 22 Rim Panic Device

Trim function	Handing	Finish	Device length	Series	Price
Exit Only	-	689	3'	22-EO-SP28	\$672.00
Exit Only	-	695	3'	22-EO-SP313	\$672.00
Exit Only	-	689	4'	22-EO-SP28	\$699.00
Exit Only	-	695	4'	22-EO-SP313	\$699.00

### 22 Rim Fire Exit Hardware

Trim function	Handing	Finish	Device length	Series	Price
Exit Only	-	689	3'	22-EO-F-SP28	\$847.00
Exit Only	-	695	3'	22-EO-F-SP313	\$847.00
Exit Only	-	689	4'	22-EO-F-SP28	\$874.00
Exit Only	-	695	4'	22-EO-F-SP313	\$874.00

### 2227 Surface Vertical Rod Panic Device

Trim function	Handing	Finish	Door height	Device length	Series	Price
Exit Only	-	689	7'	3'	2227-EO-SP28	\$1,157.00
Exit Only	-	695	7'	3'	2227-EO-SP313	\$1,157.00
Exit Only	-	689	7'	4'	2227-EO-SP28	\$1,184.00
Exit Only	-	695	7'	4'	2227-EO-SP313	\$1,184.00

### 2227-F Surface Vertical Rod Fire Exit Hardware

Trim function	Handing	Finish	Door height	Device length	Series	Price
Exit Only	-	689	7'	3'	2227-EO-F-SP28	\$1,514.00
Exit Only	-	695	7'	3'	2227-EO-F-SP313	\$1,514.00
Exit Only	-	689	7'	4'	2227-EO-F-SP28	\$1,541.00
Exit Only	-	695	7'	4'	2227-EO-F-SP313	\$1,541.00

689	695
SP28	SP313

22 SERIES

TRIM

- Two finishes available: 689 (SP28) = Aluminum Paint; 695 (SP313) = Dark Bronze Paint

22 Series Trim

Series	Lever	Handing	Finish	Price
210-DT	-	-	689	\$77.00
210-DT	-	-	695	\$77.00
210-NL	-	-	689	\$88.00
210-NL	-	-	695	\$88.00
230-L	06	LHR	689	\$340.00
230-L	06	LHR	695	\$340.00
230-L	06	RHR	689	\$340.00
230-L	06	RHR	695	\$340.00
230-NL	-	-	689	\$173.00
230-NL	-	-	695	\$173.00
230-DT	-	-	689	\$156.00
230-DT	-	-	695	\$156.00

626	630	689	695
US26D	US32D	SP28	SP313

## AUXILIARY PARTS

### Cylinders

Model number	Description	Compatible trim series	Finish	Price
3215	Mortise 1-1/4"	230L	626	\$133.00
3216	Rim Cylinder	210NL, 230NL	626	\$133.00

### Extension rods

Model number	Description	Finish	Price
ER-36	36" Extension Rod for 2227	689	\$44.00
ER-36	36" Extension Rod for 2227	695	\$44.00

### Sex bolts

Model number	Description	Finish	Price
325	325 Sex Bolt 1/4 - 20 (pkg of 2)	-	\$40.00
425	425 Sex Bolt 10-24 (Pkg of 2)	-	\$40.00

### Electronics e-Strike

Product	Finish	Price (ea.)
4211-US32D-12/24VDC-FSA/FSE	630	\$299.00
4212-US32D-12/24VDC-FSA/FSE	630	\$358.00
6111 US32D 24VDC FSE	630	\$1,338.00
6112 US32D 24VDC FSE	630	\$1,251.00
6210 US32D 24VDC FSE	630	\$1,218.00
6210 US32D 12VDC FSE	630	\$1,218.00
6210 US32D 24VDC FSE DS	630	\$1,523.00
6210 US32D 24VDC FS	630	\$1,280.00
6211 FSE 12VDC ELEC STRIKE	630	\$1,147.00
6211 FSE DS (MORT/CYL) 630	630	\$1,452.00
6211 US32D 24VDC FS	630	\$1,209.00
6211 US32D 24VDC FSE	630	\$1,147.00
6211AL US32D 24VDC FSE	630	\$1,193.00
6211WF US32D 24VDC FSE	630	\$1,161.00
6212 US32D 24VDC FSE	630	\$1,358.00
6223 FSE 24VDC ELEC STRIKE	630	\$1,279.00
5100 3FP 689 24VDC	689	\$387.00
6300 US32D 12/24VDC FSE	630	\$1,149.00
6400 US32D 12/24VDC FSE	630	\$811.00

619	625	626	630	643E	689	693	695	711
US15	US26	US26D	US32D	-	SP28	SPBLK	SP313	315

**98 SERIES**

**98 Series Panic Device**

- 3' Devices are priced complete with standard trim and strike(s)
- 4' add \$27.00 list

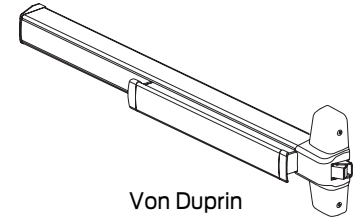

Von Duprin  
98 Series

Product	Description	626	625	619	643E	711
98EO	Rim Device	\$2,085.00	\$2,473.00	\$2,473.00	\$2,473.00	\$3,047.00
9827EO	Surface Vertical Rod Device	\$3,033.00	\$3,499.00	\$3,499.00	\$3,499.00	\$3,992.00
9849EO	Concealed Vertical Cable Device	\$3,171.00	\$3,541.00	\$3,541.00	\$3,541.00	\$4,118.00

**98 Series Fire Exit Hardware**

Product	Description	626	625	619	643E	711
98EO-F	Rim Device	\$2,386.00	\$2,774.00	\$2,774.00	\$2,774.00	\$3,348.00
9827EO-F	Surface Vertical Rod Device	\$3,477.00	\$3,943.00	\$3,943.00	\$3,943.00	\$4,436.00
9849EO-F	Concealed Vertical Cable Device	\$3,484.00	\$3,854.00	\$3,854.00	\$3,854.00	\$4,431.00

**35A SERIES**

**35A Series Panic Device**

- 3' Devices are priced complete with standard trim and strike(s)
- 4' add \$27.00 list

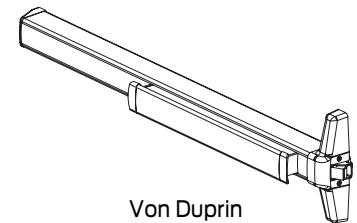

Von Duprin  
35A Series

Product	Description	626	625	619	643E	711
35A-EO	Rim Device	\$2,567.00	\$2,687.00	\$2,687.00	\$2,687.00	\$3,214.00
3549A-EO	Concealed Vertical Cable Device	\$3,649.00	\$3,781.00	\$3,781.00	\$3,781.00	\$4,442.00

**35A Series Fire Exit Hardware**

Product	Description	626	625	619	643E	711
35A-EO-F	Rim Device	\$2,606.00	\$2,726.00	\$2,726.00	\$2,726.00	\$3,253.00
3549A-EO-F	Concealed Vertical Cable Device	\$3,803.00	\$3,935.00	\$3,935.00	\$3,935.00	\$4,596.00

CONCEALED VERTICAL CABLE (CVC) REFERENCE:	
NOMINAL DOOR OPENING HEIGHT	
72"-82"	6'-6'10"
* >82"-96"	* >6'10"-8'
>96"-110"	>8'-9'2"
>110"-120"	>9'2"-10'

\* Default door opening height. Specify height if other than default.

619	625	626	630	643E	689	693	695	711
US15	US26	US26D	US32D	-	SP28	SPBLK	SP313	315

35A/98 SERIES

OPTIONS

**Dogging option**

Description	Specify (Prefix)	Price adjustment
Less Dogging	LD	No charge

**Weep holes**

Description	Specify (Suffix)	Price adjustment
Drainage (weep) holes in mechanism case	WH	\$134.00
3' device will have 5 holes - 6" spacing, 4' device will have 7 holes - 6" spacing		

**Switches**

Description	Specify (Prefix)	Price adjustment
Request to Exit - available on all 35A and 98 Series Devices	RX	\$383.00

**Electric latch retraction**

Description	Specify (Prefix)	Price adjustment
Quiet Electric Latch Retraction - available on all 35A and 98 Series Devices	QEL	\$1,321.00

**Motorized electric unlocking**

Description	Specify	Price adjustment
Motorized Electronic Unlocking for outside M996 Trim - for 98 devices	M996	\$953.00
Available with L or LBE functions only. Specify Handing.		
Ships FAIL SAFE (FS), but can be field converted to FAIL SECURE (FSE) with dip switch		

**Allegion Connect**

Description	Specify (Suffix)	Price adjustment
Cross-category solution using common interconnect components for electrified options. Available with RX switches, QEL, and M996.	CON	No charge

Note: For wire harness options, refer to Power Supply and Electronic Component Section in Von Duprin Price Book .



619	625	626	630	643E	689	693	695	711
US15	US26	US26D	US32D	-	SP28	SPBLK	SP313	315

**35A/98 SERIES** ACCESSORIES

**Dummy touch bars**

- 3' Devices are priced complete with sex bolts
- 4' add \$27.00 list

Description	Specify		619, 625, 626, 643e	711
	Model number	Finish		
35A/98 Series device dummy touch bar	350	.[Finish]	\$1,189.00	\$2,137.00

**Power transfer**

Description	Specify		689
	Model number	Finish	
Ten 24 gauge wires	EPT10	.[Finish]	\$764.00
Ten 24 gauge wires with connectors	EPT10 CON	.[Finish]	\$781.00

**35A/98 SERIES** TRIM

**Lever designs**

Model number	Description
Standard	06 Lever Design - furnished standard. Optional Lever Designs - Latitude (LAT),17, 07
Handing	Field reversible and furnished RHR if not specified

**98 Series Trim**

- Specify device type when ordering (example: 996L-R)

Description	Specify			622, 626, 695	619, 625, 643e	693
	Model number	Device type	Finish			
Night Latch Cyl. Assy, MD Dr	110MD-NL	-	.[Finish]	\$196.00	\$196.00	\$196.00
Lever	996L	R&V	.[Finish]	\$869.00	\$984.00	\$901.00
Lever, blank escutcheon	996L-BE	R&V	.[Finish]	\$869.00	\$984.00	\$901.00
Lever, night latch	996L-NL	R&V	.[Finish]	\$693.00	\$808.00	\$725.00

**35A Series Trim**











Description	Specify		626	625	619	643E
	Model number	Finish				
Night latch cylinder trim	388 (NL-OP)	.[Finish]	\$451.00	\$451.00	\$451.00	\$451.00

605	606	612	613	619	622	625	626
US3	US4	US10	US10B	US15	US19	US26	US26D
628	629	630	643E	689	695	710	711
US28	US32	US32D	US11	SP28	SP313	313AN	DC35

## FALCON EXIT DEVICES ■ 24 SERIES

### 24-R Series Rim Panic Device

■ 3' device pricing shown. 4' add \$26.00 list



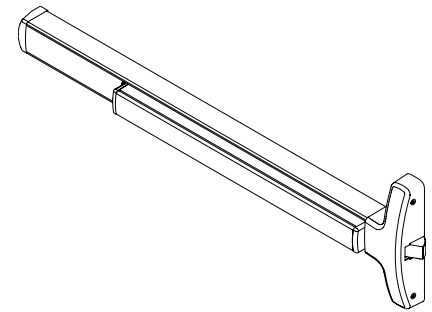







Product	Trim/Control	622, 626	625	619, 643E
24-R-EO <sup>1</sup>	N/A	\$1,944.00	\$2,015.00	\$2,194.00
24-R-NL-OP <sup>1</sup>	(Supplied as NL less trim)	\$1,944.00	\$2,015.00	\$2,194.00
24-R-L <sup>1</sup>	712L 	\$2,479.00	\$2,550.00	\$2,729.00
24-R-L-BE <sup>1</sup>	712L-BE 	\$2,479.00	\$2,550.00	\$2,729.00
24-R-L-NL <sup>1</sup>	712L-NL 	\$2,479.00	\$2,550.00	\$2,729.00
24-R-L-DT <sup>1</sup>	712L-DT 	\$2,479.00	\$2,550.00	\$2,729.00
24-R-K	711K 	\$2,379.00	\$2,450.00	\$2,629.00
24-R-K-BE	711K-BE 	\$2,379.00	\$2,450.00	\$2,629.00
24-R-K-NL	711K-NL 	\$2,379.00	\$2,450.00	\$2,629.00
24-R-DT	717DT 	\$2,308.00	\$2,379.00	\$2,558.00
24-R-DT	718DT 	\$2,337.00	\$2,408.00	\$2,587.00
24-R-NL <sup>1</sup>	718NL 	\$2,308.00	\$2,379.00	\$2,558.00
24-R-C <sup>1</sup>	718C 	\$2,223.00	\$2,294.00	\$2,473.00



Falcon 24 Series

### F-24-R Series Rim Fire Exit Hardware

■ 3' device pricing shown. 4' add \$26.00 list

Product	Trim/Control	622, 626	625	619, 643E
F-24-R-EO <sup>1</sup>	N/A	\$2,231.00	\$2,302.00	\$2,481.00
F-24-R-NL-OP <sup>1</sup>	(Supplied as NL less trim)	\$2,231.00	\$2,302.00	\$2,481.00
F-24-R-L <sup>1</sup>	712L 	\$2,766.00	\$2,837.00	\$3,016.00
F-24-R-L-BE <sup>1</sup>	712L-BE 	\$2,766.00	\$2,837.00	\$3,016.00
F-24-R-L-NL <sup>1</sup>	712L-NL 	\$2,766.00	\$2,837.00	\$3,016.00
F-24-R-L-DT <sup>1</sup>	712L-DT 	\$2,766.00	\$2,837.00	\$3,016.00
F-24-R-K	711K 	\$2,666.00	\$2,737.00	\$2,916.00
F-24-R-K-BE	711K-BE 	\$2,666.00	\$2,737.00	\$2,916.00
F-24-R-K-NL	711K-NL 	\$2,666.00	\$2,737.00	\$2,916.00
F-24-R-DT	717DT 	\$2,595.00	\$2,666.00	\$2,845.00
F-24-R-DT	718DT 	\$2,624.00	\$2,695.00	\$2,874.00
F-24-R-NL <sup>1</sup>	718NL 	\$2,595.00	\$2,666.00	\$2,845.00
F-24-R-C <sup>1</sup>	718C 	\$2,510.00	\$2,581.00	\$2,760.00

 24-R/F-24-R noted trims are handed and field reversible. These trims are furnished RHR when handing is not specified.

1. These devices and 712L, 712L-BE, 712L-NL, 712L-DT, 718C, 718NL trims are available in 619 (US15), 622 (US19), and 643e (US11) finishes.
2. 24 Series ordered in 710 (313AN) will be supplied with trims in 695 (SP313).

#### DEFAULT ATTRIBUTES

Pricing includes default options shown below. Additional options and configurations available.

Cylinders	Sex bolts	Door thickness	Center line
Not included	Included on F-24-R only	1-3/4"	40"

**Strike(s):** Panic includes 299, Fire includes 299F

## 24 SERIES

605	606	612	613	619	622	625	626
US3	US4	US10	US10B	US15	US19	US26	US26D
628	629	630	643E	689	695	710	711
US28	US32	US32D	US11	SP28	SP313	313AN	DC35

### 24-V Series Surface Vertical Rod Panic Device 🖱️

- 3' device pricing shown. 4' add \$26.00 list; 2' (less label)<sup>4</sup> add \$157.00 list.

Product	Trim/Control	622, 626	625	619, 643E
24-V-EO <sup>1</sup>	N/A	\$2,548.00	\$2,644.00	\$2,851.00
24-V-NL-OP <sup>1</sup>	(Supplied as NL less trim)	\$2,548.00	\$2,644.00	\$2,851.00
24-V-L <sup>1</sup>	712L 🖱️	\$3,083.00	\$3,179.00	\$3,386.00
24-V-L-BE <sup>1</sup>	712L-BE 🖱️	\$3,083.00	\$3,179.00	\$3,386.00
24-V-L-NL <sup>1</sup>	712L-NL 🖱️	\$3,083.00	\$3,179.00	\$3,386.00
24-V-L-DT <sup>1</sup>	712L-DT 🖱️	\$3,083.00	\$3,179.00	\$3,386.00
24-V-K	711K 🖱️	\$2,983.00	\$3,079.00	\$3,286.00
24-V-K-BE	711K-BE 🖱️	\$2,983.00	\$3,079.00	\$3,286.00
24-V-K-NL	711K-NL 🖱️	\$2,983.00	\$3,079.00	\$3,286.00
24-V-DT	717DT 🖱️	\$2,912.00	\$3,008.00	\$3,215.00
24-V-DT	718DT 🖱️	\$2,941.00	\$3,037.00	\$3,244.00
24-V-NL <sup>1</sup>	718NL 🖱️	\$2,912.00	\$3,008.00	\$3,215.00
24-V-C <sup>1</sup>	718C 🖱️	\$2,827.00	\$2,923.00	\$3,130.00

### F-24-V Series Surface Vertical Rod Fire Exit Hardware 🖱️

- 3' device pricing shown. 4' add \$26.00 list; 2' (less label)<sup>4</sup> add \$157.00 list.

Product	Trim/Control	622, 626	625	619, 643E
F-24-V-EO <sup>1</sup>	N/A	\$2,814.00	\$2,910.00	\$3,117.00
F-24-V-NL-OP <sup>1</sup>	(Supplied as NL less trim)	\$2,814.00	\$2,910.00	\$3,117.00
F-24-V-L <sup>1</sup>	712L 🖱️	\$3,349.00	\$3,445.00	\$3,652.00
F-24-V-L-BE <sup>1</sup>	712L-BE 🖱️	\$3,349.00	\$3,445.00	\$3,652.00
F-24-V-L-NL <sup>1</sup>	712L-NL 🖱️	\$3,349.00	\$3,445.00	\$3,652.00
F-24-V-L-DT <sup>1</sup>	712L-DT 🖱️	\$3,349.00	\$3,445.00	\$3,652.00
F-24-V-K	711K 🖱️	\$3,249.00	\$3,345.00	\$3,552.00
F-24-V-K-BE	711K-BE 🖱️	\$3,249.00	\$3,345.00	\$3,552.00
F-24-V-K-NL	711K-NL 🖱️	\$3,249.00	\$3,345.00	\$3,552.00
F-24-V-DT	717DT 🖱️	\$3,178.00	\$3,274.00	\$3,481.00
F-24-V-DT	718DT 🖱️	\$3,207.00	\$3,303.00	\$3,510.00
F-24-V-NL <sup>1</sup>	718NL 🖱️	\$3,178.00	\$3,274.00	\$3,481.00
F-24-V-C <sup>1</sup>	718C 🖱️	\$3,093.00	\$3,189.00	\$3,396.00

🖱️ 24-V/F-24-V devices and noted trims are handed and field reversible. The device and trims are furnished RHR when handing is not specified.

1. These devices and 712L, 712L-BE, 712L-NL, 712L-DT, 718C, 718NL trims are available in 619 (US15), 622 (US19), and 643e (US11) finishes.
2. 24 Series ordered in 710 (313AN) will be supplied with trims in 695 (SP313).
3. 24-V device ordered in 619 (US15) will be supplied with 630 (US32D) Rod and latch cover.
4. 2' devices will have 10" touch pad.

#### DEFAULT ATTRIBUTES

Pricing includes default options shown below. Additional options and configurations available.

Cylinders	Sex bolts	Strike(s)	Door thickness	Center line
Not included	Included on F-24-V only	3788 and 2130	1-3/4"	40"

**Extension rods:** For door heights over 7'0" up to 8'0", 12" extension rods are furnished at no additional charge at the time of device order. Must specify door height on order line. For door heights over 8'0" up to 10'0", extension rods are furnished at prices shown in parts section with the device at the time of order. Must specify door height on order line.

605	606	612	613	619	622	625	626
US3	US4	US10	US10B	US15	US19	US26	US26D
628	629	630	643E	689	695	710	711
US28	US32	US32D	US11	SP28	SP313	313AN	DC35

**24 SERIES**    OPTIONS

SEX BOLTS Optional Sex Bolts are recommended for center case mounting when device is used with hollow core wood, composite or light gauge hollow metal doors. See chart below for quantities and list prices.	Quantity			Price adjustment
	2729	325	425	
24-R-EO (Exit Only device)	-	2	4	\$120.00
24-R Device x Trim	-	-	4	\$80.00
24-V-EO (Exit Only device)	6	2	2	\$182.00
24-V Device x Trim	6	-	2	\$142.00
24-V-EO (Exit Only device) LBR	3	2	2	\$131.00
24-V Device x Trim LBR	3	-	2	\$91.00

LESS BOTTOM ROD LBR/LBL Fire-Rated Devices must be ordered in pairs, and one Auxiliary Fire Pin (AFL) is furnished per pair.	Specify (Suffix)	Price adjustment
Less bottom rod available with UL Fire Label at no additional charge on F-24-V and F-24-C devices	LBR	No charge

CYLINDER DOGGING - NOT FOR USE WITH FIRE EXIT HARDWARE	Specify (Prefix)	Price adjustment
Cylinder dogging available on all 24 Series panic devices.	CD	\$90.00
Less dogging available on all 24 Series panic devices.	LD	No charge

SWITCHES - Available on all 24 Series devices	Specify (Prefix)	Price adjustment
Touch bar Request-to-Exit switch <ul style="list-style-type: none"> <li>RX device monitoring switch can be used in combination with a second DM or LM switch (except for 24-R Panic and Fire)</li> </ul>	RX	\$295.00
Key override <ul style="list-style-type: none"> <li>Override device monitoring on a door by use of a keyed cylinder</li> <li>KOR must be used in combination with a device monitoring switch.</li> </ul>	KOR	\$79.00

LATCH RETRACTION - Available on all 24 Series Panic and Fire devices	Specify (Prefix)	Price adjustment
Motorized electric latch retraction Cannot be used in combination with HD, CD, EA, or KOR options	MEL	\$980.00

EXIT ALARM	Specify (Prefix)	Price adjustment
Exit alarm <ul style="list-style-type: none"> <li>Available on 24R, 24V, 24C, and 24C-WDC panic and fire devices</li> <li>Price includes RX switch; can substitute with DC switch at no additional charge</li> <li>To order Less Switch, deduct -\$295.00 list</li> </ul>	EA	\$734.00

CONNECTORS	Specify (Suffix)	Price adjustment
Cross-category solution using common interconnect components for electrified options <ul style="list-style-type: none"> <li>Available with MEL, MEL-RX, RX, EA options.</li> </ul>	CON	No charge

Note: For wire harness options refer to Power Supply and Electronic Component Section in the Falcon Price Book.

605	606	612	613	619	622	625	626
US3	US4	US10	US10B	US15	US19	US26	US26D
628	629	630	643E	689	695	710	711
US28	US32	US32D	US11	SP28	SP313	313AN	DC35

### 24 SERIES

### TRIM

- Cylinders are not included in the price.
- 711, 717, 718, and 712 Series Trim are handed and field reversible. These trims are furnished RHR when handing is not specified.

ATHENA TRIM					
Description	Specify			619	625, 626
	Model number	Device type	Finish		
Dummy Trim	715DT	.[R or V]	.[Finish]	\$321.00	\$321.00

CONTROL TRIM					
Description	Specify			619	625, 626
	Model number	Device type	Finish		
Knob, Key Locks or Unlocks	711K	.[R or V]	.[Finish]	\$435.00	\$435.00
Knob, Key Locks or Unlocks	711K	C	.[Finish]	\$435.00	\$435.00
Knob, Blank Escutcheon	711K-BE	.[R or V]	.[Finish]	\$435.00	\$435.00
Knob, Blank Escutcheon	711K-BE	C	.[Finish]	\$435.00	\$435.00
Knob, Night Latch	711K-NL	.[R or V]	.[Finish]	\$435.00	\$435.00
Knob, Night Latch	711K-NL	C	.[Finish]	\$435.00	\$435.00

DELTA CONTROLS					
Description	Specify			619	625, 626
	Model number	Device type	Finish		
Dummy Trim	717DT	.[R or V]	.[Finish]	\$364.00	\$364.00
Dummy Trim	717DT	C	.[Finish]	\$364.00	\$364.00

DELTA CONTROLS					
Description	Specify			619	622, 625, 626, 643E
	Model number	Device type	Finish		
Dummy Trim	718DT	C	.[Finish]	\$393.00	\$393.00
Night Latch <sup>1</sup>	718NL	.[R or V]	.[Finish]	\$364.00	\$364.00
Night Latch <sup>1</sup>	718NL	C	.[Finish]	\$364.00	\$364.00
Night Latch Less Pull <sup>1</sup>	718C	.[R or V]	.[Finish]	\$279.00	\$279.00
Night Latch Less Pull <sup>1</sup>	718C	C	.[Finish]	\$279.00	\$279.00

Available in 622 and 643e finish.

CONTROL LEVER TRIMS					
Description	Specify			619	622, 625, 626, 643E
	Model number	Device type	Finish		
Dane Lever, Key Locks or Unlocks	712L	.[R or V]	.[Finish]	\$535.00	\$535.00
Dane Lever, Key Locks or Unlocks	712L	C	.[Finish]	\$535.00	\$535.00
Dane Lever, Blank Escutcheon	712L-BE	.[R or V]	.[Finish]	\$535.00	\$535.00
Dane Lever, Blank Escutcheon	712L-BE	C	.[Finish]	\$535.00	\$535.00
Dane Lever, Night Latch	712L-NL	.[R or V]	.[Finish]	\$535.00	\$535.00
Dane Lever, Night Latch	712L-NL	C	.[Finish]	\$535.00	\$535.00
Dane Lever, Dummy Trim	712L-DT	.[R or V]	.[Finish]	\$535.00	\$535.00
Dane Lever, Dummy Trim	712L-DT	C	.[Finish]	\$535.00	\$535.00





1. Available in 622 and 643e finish.
2. The Dane Lever is furnished standard. Optional lever designs Sutro, Quantum, Avalon, Danish, Broadway, Boardwalk, Longitude, and Latitude are available at no additional charge.
3. 24 Series ordered in 630 (US32D) will be supplied with trims in 619 (US15).

605	606	612	613	619	622	625	626
US3	US4	US10	US10B	US15	US19	US26	US26D
628	629	630	643E	689	695	710	711
US28	US32	US32D	US11	SP28	SP313	313AN	DC35

## 25 SERIES

### 25-R Series Rim Panic Device

- 3' device pricing shown. 4' add \$26.00 list.



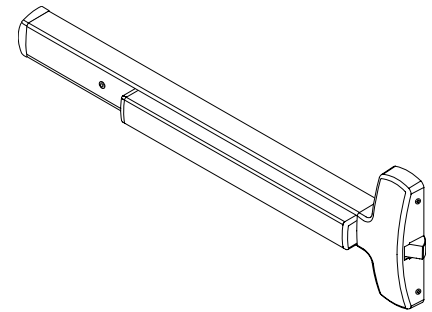



Product	Trim/Control	622, 626	625	619, 643E
25-R-EO <sup>1</sup>	N/A	\$1,509.00	\$1,570.00	\$1,765.00
25-R-NL-OP <sup>1</sup>	Supplied NL less trim	\$1,509.00	\$1,570.00	\$1,765.00
25-R-L <sup>1</sup>	510L 	\$2,050.00	\$2,124.00	\$2,319.00
25-R-L-BE <sup>1</sup>	510L-BE 	\$2,050.00	\$2,124.00	\$2,319.00
25-R-L-NL <sup>1</sup>	510L-NL 	\$1,951.00	\$2,077.00	\$2,272.00
25-R-L-DT <sup>1</sup>	510L-DT 	\$1,951.00	\$2,077.00	\$2,272.00
25-R-L <sup>1</sup>	511L 	\$2,134.00	\$2,202.00	\$2,397.00
25-R-TP	512TP	\$1,968.00	\$2,112.00	-
25-R-TP-BE	512TP-BE	\$1,968.00	\$2,112.00	-
25-R-NL <sup>1</sup>	512-NL	\$1,875.00	\$2,001.00	\$2,196.00
25-R-K	513K	\$1,917.00	\$2,045.00	-
25-R-K-BE	513K-BE	\$1,917.00	\$2,045.00	-
25-R-K-NL	513K-NL	\$1,917.00	\$2,045.00	-
25-R-K-DT	513K-DT	\$1,917.00	\$2,045.00	-
25-R-DT	717DT 	\$1,873.00	\$1,934.00	\$2,129.00
25-R-DT	512DT	\$1,792.00	\$1,999.00	\$2,194.00



Falcon 25 Series

### F-25-R Series Rim Fire Exit Hardware

- 3' device pricing shown. 4' add \$26.00 list.

Product	Trim/Control	622, 626	625	619, 643E
F-25-R-EO <sup>1</sup>	N/A	\$1,799.00	\$1,860.00	\$2,055.00
F-25-R-NL-OP <sup>1</sup>	Supplied NL less trim	\$1,799.00	\$1,860.00	\$2,055.00
F-25-R-L <sup>1</sup>	510L 	\$2,340.00	\$2,414.00	\$2,609.00
F-25-R-L-BE <sup>1</sup>	510L-BE 	\$2,340.00	\$2,414.00	\$2,609.00
F-25-R-L-NL <sup>1</sup>	510L-NL 	\$2,241.00	\$2,367.00	\$2,562.00
F-25-R-L-DT <sup>1</sup>	510L-DT 	\$2,241.00	\$2,367.00	\$2,562.00
F-25-R-L <sup>1</sup>	511L 	\$2,424.00	\$2,492.00	\$2,687.00
F-25-R-TP	512TP	\$2,258.00	\$2,402.00	-
F-25-R-TP-BE	512TP-BE	\$2,258.00	\$2,402.00	-
F-25-R-NL <sup>1</sup>	512-NL	\$2,165.00	\$2,291.00	\$2,486.00
F-25-R-K	513K	\$2,207.00	\$2,335.00	-
F-25-R-K-BE	513K-BE	\$2,207.00	\$2,335.00	-
F-25-R-K-NL	513K-NL	\$2,207.00	\$2,335.00	-
F-25-R-K-DT	513K-DT	\$2,207.00	\$2,335.00	-
F-25-R-DT	717DT 	\$2,163.00	\$2,224.00	\$2,419.00
F-25-R-DT	512DT	\$2,082.00	\$2,289.00	\$2,484.00

 Handed and field reversible

1. These devices and 510L, 510L-BE, 510L-NL, 510L-DT, 511L, 512NL trims are available in 619 (US15), 622 (US19), and 643e (US11) finishes.
2. 25 Series ordered in 710 (313AN) will be supplied with trims in 695 (SP313).
3. 25-R/F-25-R device is non-handed. Trims are furnished RHR when handing is not specified.

### DEFAULT ATTRIBUTES

Pricing includes default options shown below. Additional options and configurations available.

Cylinders	Sex bolts	Door thickness	Center line
Not included	Included on F-25-R only	1-3/4"	40-1/4"

**Strike(s):** Panic includes 299, Fire includes 299F

605	606	612	613	619	622	625	626
US3	US4	US10	US10B	US15	US19	US26	US26D
628	629	630	643E	689	695	710	711
US28	US32	US32D	US11	SP28	SP313	313AN	DC35

## 25 SERIES

### 25-V Series Surface Vertical Rod Panic Device 🖱️

- 3' device pricing shown. 4' add \$26.00 list; 2' (less label)<sup>4</sup> add \$157.00 list.

Product	Trim/Control	622, 626	625	619, 643E
25-V-EO <sup>1</sup>	N/A	\$2,189.00	\$2,283.00	\$2,458.00
25-V-NL-OP <sup>1</sup>	Supplied NL less trim	\$2,189.00	\$2,283.00	\$2,458.00
25-V-L <sup>1</sup>	510L	\$2,730.00	\$2,837.00	\$3,012.00
25-V-L-BE <sup>1</sup>	510L-BE	\$2,730.00	\$2,837.00	\$3,012.00
25-V-L-NL <sup>1</sup>	510L-NL	\$2,631.00	\$2,790.00	\$2,965.00
25-V-L-DT <sup>1</sup>	510L-DT	\$2,631.00	\$2,790.00	\$2,965.00
25-V-L <sup>1</sup>	511L	\$2,814.00	\$2,915.00	\$3,090.00
25-V-TP	512TP	\$2,648.00	\$2,825.00	-
25-V-TP-BE	512TP-BE	\$2,648.00	\$2,825.00	-
25-V-NL <sup>1</sup>	512-NL	\$2,555.00	\$2,714.00	\$2,889.00
25-V-K	513K	\$2,597.00	\$2,758.00	-
25-V-K-BE	513K-BE	\$2,597.00	\$2,758.00	-
25-V-K-NL	513K-NL	\$2,597.00	\$2,758.00	-
25-V-K-DT	513K-DT	\$2,597.00	\$2,758.00	-
25-V-DT	717DT	\$2,553.00	\$2,647.00	\$2,822.00
25-V-DT	512DT	\$2,472.00	\$2,712.00	\$2,887.00

### F-25-V Series Surface Vertical Rod Fire Exit Hardware 🖱️

- 3' device pricing shown. 4' add \$26.00 list; 2' (less label)<sup>4</sup> add \$157.00 list.

Product	Trim/Control	622, 626	625	619, 643E
F-25-V-EO <sup>1</sup>	N/A	\$2,456.00	\$2,550.00	\$2,725.00
F-25-V-NL-OP <sup>1</sup>	Supplied NL less trim	\$2,456.00	\$2,550.00	\$2,725.00
F-25-V-L <sup>1</sup>	510L	\$2,997.00	\$3,104.00	\$3,279.00
F-25-V-L-BE <sup>1</sup>	510L-BE	\$2,997.00	\$3,104.00	\$3,279.00
F-25-V-L-NL <sup>1</sup>	510L-NL	\$2,898.00	\$3,057.00	\$3,232.00
F-25-V-L-DT <sup>1</sup>	510L-DT	\$2,898.00	\$3,057.00	\$3,232.00
F-25-V-L <sup>1</sup>	511L	\$3,081.00	\$3,182.00	\$3,357.00
F-25-V-TP	512TP	\$2,915.00	\$3,092.00	-
F-25-V-TP-BE	512TP-BE	\$2,915.00	\$3,092.00	-
F-25-V-NL <sup>1</sup>	512-NL	\$2,822.00	\$2,981.00	\$3,156.00
F-25-V-K	513K	\$2,864.00	\$3,025.00	-
F-25-V-K-BE	513K-BE	\$2,864.00	\$3,025.00	-
F-25-V-K-NL	513K-NL	\$2,864.00	\$3,025.00	-
F-25-V-K-DT	513K-DT	\$2,864.00	\$3,025.00	-
F-25-V-DT	717DT	\$2,820.00	\$2,914.00	\$3,089.00
F-25-V-DT	512DT	\$2,739.00	\$2,979.00	\$3,154.00

🖱️ 25-V/F-25-V device is handed and field reversible. Trims are furnished RHR when handing is not specified.

1. These devices and 510L, 510L-BE, 510L-NL, 510L-DT, 511L, 512NL trims are available in 619 (US15), 622 (US19), and 643e (US11) finishes.
2. 25 Series ordered in 710 (313AN) will be supplied with trims in 695 (SP313).
3. 25-V Device ordered in 619 (US15) will be supplied with 630 (US32D) Rod and latch cover.
4. 2' devices will have 10" touch pad.

#### DEFAULT ATTRIBUTES

Pricing includes default options shown below. Additional options and configurations available.

Cylinders	Sex bolts	Strike(s)	Door thickness	Center line
Not included	Included on F-25-V only	3788 and 2130	1-3/4"	40"

**Extension rods:** For door heights over 7'0" up to 8'0", 12" extension rods are furnished at no additional charge at the time of device order. Must specify door height on order line. For door heights over 8'0" up to 10'0", extension rods are furnished at prices shown in parts section with the device at the time of order. Must specify door height on order line.

605	606	612	613	619	622	625	626
US3	US4	US10	US10B	US15	US19	US26	US26D
628	629	630	643E	689	695	710	711
US28	US32	US32D	US11	SP28	SP313	313AN	DC35

25 SERIES

OPTIONS

SEX BOLTS Optional Sex Bolts are recommended for center case mounting when device is used with hollow core wood, composite or light gauge hollow metal doors. See chart below for quantities and list prices.	Quantity		Price adjustment
	2729	425	
25-R-EO (Exit Only device)	-	8	\$160.00
25-R Device x Trim	-	4	\$80.00
25-V-EO (Exit Only device)	6	6	\$222.00
25-V Device x Trim	6	2	\$142.00
25-V-EO (Exit Only device) LBR	3	6	\$171.00
25-V Device x Trim LBR	3	2	\$91.00

LESS BOTTOM ROD (LBR/LBL Fire-Rated Devices must be ordered in pairs, and one Auxiliary Fire Pin (AFL) is furnished per pair.)	Specify (Suffix)	Price adjustment
Less bottom rod available with UL Fire Label at no additional charge on F-25-V and F-25-C devices	LBR	No charge

CYLINDER DOGGING - Not for use with fire exit hardware	Specify (Prefix)	Price adjustment
Cylinder dogging available on all 25 Series panic devices	CD	\$90.00
Less dogging available on all 25 Series panic devices	LD	No charge

ELECTRIC LOCK OR UNLOCK OF TRIMS - Available on all 25 Series devices	Specify (Prefix)	Price adjustment
Electric Lock/Unlock Trim, Fail Safe (unlocks when power is interrupted)	FSA	\$432.00
Electric Lock/Unlock Trim, Fail Secure (locks when power is interrupted)	FSE	\$432.00

Available with TP, K, or L functions only. Can be used in combination with MEL, EA, or any device monitoring switch. Power supply PS902 is the recommended power supply for use with FSA/FSE trim. See the Power Supply section on page 61 for more information.

SWITCHES - Available on all 25 Series devices	Specify (Prefix)	Price adjustment
Touch bar Request-to-Exit switch ▪ RX dogging monitoring switch can be used in combination with a second DM or LM switch	RX	\$295.00
Latch bolt monitor switch (provide signal when latch bolt is fully extended) ▪ DM device monitoring switch can be used in combination with a RX switch	DM	\$311.00
Latch bolt monitor switch (provide signal when latch bolt is fully retracted) ▪ LM device monitoring switch can be used in combination with a RX switch	LM	\$295.00
Key override ▪ Override device monitoring on a door by use of a keyed cylinder ▪ KOR must be used in combination with a device monitoring switch	KOR	\$79.00

LATCH RETRACTION - Available on all 25 Series Panic and Fire devices except for 25-M and F-25-M	Specify (Prefix)	Price adjustment
Motorized electric latch retraction ▪ Cannot be used in combination with HD, CD, EA, or KOR options	MEL	\$980.00

EXIT ALARM	Specify (Prefix)	Price adjustment
Exit alarm ▪ Available on 25R, 25V, 25C, 25C-WDC, and 25M panic and fire devices ▪ Price includes RX switch; can substitute with LM switch at no additional charge ▪ For vertical rod tampering monitoring on Surface Vertical Devices, specify device with DM (Latch Bolt Monitor Switch). Add \$311.00 list ▪ To order Less switch, deduct -\$295.00 list ▪ 9 volt battery included	EA	\$734.00



25 SERIES

OPTIONS

605	606	612	613	619	622	625	626
US3	US4	US10	US10B	US15	US19	US26	US26D
628	629	630	643E	689	695	710	711
US28	US32	US32D	US11	SP28	SP313	313AN	DC35

HURRICANE DEVICE	Specify (Prefix)	Price adjustment
Meets all FBC Hurricane Listings. Consult factory for specific Applications.		
<b>Hurricane option</b> <ul style="list-style-type: none"> <li>Available on 25-R<sup>1</sup>, F-25-R, 25-V, F-25-V</li> <li>Prefix device "HH"</li> </ul>	HH	\$40.00
<b>Standard devices 25-C, F-25-C, 25-M, F-25-M</b> <ul style="list-style-type: none"> <li>Meet all FBC Hurricane listing requirements</li> <li>Consult factory for specific applications</li> <li>Prefix "HH" is not required on these devices</li> </ul>	-	No charge

1. HH-25-R requires 299F Strike. Strike 299F will be provided/charged in place of Strike 299.
2. HH-25-V-EO and HH-F-25-V-EO, will be supplied with twelve sex bolts. Add \$222.00 List.
3. Other device functions will be supplied with eight sex bolts. Add \$142.00 List.

ACCESSIBLE DEVICE	Specify (Suffix)	Price adjustment
<ul style="list-style-type: none"> <li>Accessible device compliant with the California Building Code (Section 11B-309.4) requirement for 5 lb. maximum operational force.</li> <li>Available on 3' and 4' AX25-R/F-25-R Rim, AX25-V/AXF-25V, AX25V-LBR/AXF-25V-LBR/LBR-AFL, AX25-C/AXF-25C, AX25-C-LBR/AX-F-25-C-LBR/LBR-AFL</li> <li>Trim functions available EO, DT, NL, L, L-BE, L-NL, L-DT, NL-OP, and C</li> <li>Other device &amp; Trim options compatible with AX25 devices: MEL, RX, DM, LM, CON, EA, FSA/FSE, CD, LD</li> </ul>	AX	\$35.00

CONNECTORS	Specify (Suffix)	Price adjustment
Cross-category solution using common interconnect components for electrified options. <ul style="list-style-type: none"> <li>Available with MEL, MEL-RX, RX, EA options.</li> </ul>	CON	No charge

Note: For wire harness options refer to Power Supply and Electronic Component Section in the Falcon Price Book.

<b>605</b>	<b>606</b>	<b>612</b>	<b>613</b>	<b>619</b>	<b>622</b>	<b>625</b>	<b>626</b>
US3	US4	US10	US10B	US15	US19	US26	US26D
<b>628</b>	<b>629</b>	<b>630</b>	<b>643E</b>	<b>689</b>	<b>695</b>	<b>710</b>	<b>711</b>
US28	US32	US32D	US11	SP28	SP313	313AN	DC35

### 25 SERIES

### TRIM

- Cylinders are not included in price.
- 510, 511, 717, and 718 series trim are handed and field reversible. Trims are furnished RHR when handing is not specified.
- Electric Lock or Unlock option is available on 510L, 511L, 512TP, and 513K functions only. Suffix FSA for Fail Safe operation, or FSE for Fail Secure operation, add \$432.00 List.

LEVER TRIM					
Description	Specify			622 <sup>2</sup> , 626	619 <sup>2</sup> , 625, 629, 643e <sup>2</sup>
	Model number	Device type	Finish		
Dane Lever, Key Locks or Unlocks	510L	[R, V, M, or C]	[Finish]	\$541.00	\$554.00
Dane Lever, Night Latch	510L-NL	[R, V, M, or C]	[Finish]	\$442.00	\$507.00
Dane Lever, Dummy Trim	510L-DT	[R, V, M, or C]	[Finish]	\$442.00	\$507.00
Dane Lever, Blank Escutcheon	510L-BE	[R, V, M, or C]	[Finish]	\$541.00	\$554.00

1. The Dane lever is furnished standard. Optional lever designs Broadway, Boardwalk, Danish, Latitude, Longitude, Sutro, Quantum and Avalon are available at no additional charge.
2. 619, 622, and 643e are available on the lever trim type listed above except Sutro.
3. KN for Knurling on Dane lever, add \$91.00 List. Contact factory for lead times.

VANDAL RESISTANT TRIM					
Description	Specify			622 <sup>5</sup> , 626, 630	619 <sup>5</sup> , 625, 629, 643e <sup>5</sup>
	Model number	Device type	Finish		
Dane Lever, Key Locks or Unlocks	511L	[R, V, M, or C]	[Finish]	\$625.00	\$632.00

4. The Dane Lever is furnished standard. Optional lever designs Broadway, Boardwalk, Danish, Latitude, Longitude, Sutro, Quantum, and Avalon are available at no additional charge.
5. 619, 622, and 643e are available on the lever trim type listed above except Sutro.

NIGHT LATCH AND THUMBPIECE TRIM					
Description	Specify			622 <sup>1</sup> , 626, 630	605, 619, 625, 629, 643e
	Model number	Device type	Finish		
Night Latch	512NL	[R, V, M, or C]	[Finish]	\$366.00	\$431.00
Thumbpiece, Key Locks or Unlocks	512TP	[R, V, M, or C]	[Finish]	\$459.00	\$542.00
Thumbpiece, Blank Escutcheon	512TP-BE	[R, V, M, or C]	[Finish]	\$459.00	\$542.00

KNOB TRIM					
Description	Specify			626, 630	605, 625, 629
	Model number	Device type	Finish		
Knob, Key Locks or Unlocks	513K	[R, V, M, or C]	[Finish]	\$408.00	\$475.00
Knob, Night Latch	513K-NL	[R, V, M, or C]	[Finish]	\$408.00	\$475.00
Knob, Dummy Trim	513K-DT	[R, V, M, or C]	[Finish]	\$408.00	\$475.00
Knob, Blank Escutcheon	513K-BE	[R, V, M, or C]	[Finish]	\$408.00	\$475.00

**25 SERIES** TRIM

<b>605</b>	<b>606</b>	<b>612</b>	<b>613</b>	<b>619</b>	<b>622</b>	<b>625</b>	<b>626</b>
US3	US4	US10	US10B	US15	US19	US26	US26D
<b>628</b>	<b>629</b>	<b>630</b>	<b>643E</b>	<b>689</b>	<b>695</b>	<b>710</b>	<b>711</b>
US28	US32	US32D	US11	SP28	SP313	313AN	DC35

- Cylinders are not included in the price.
- 510, 511, 717, and 718 series trim are handed and field reversible. Trims are furnished RHR when handing is not specified.
- Electric Lock or Unlock option is available on 510L, 511L, 512TP, and 513K functions only. Suffix FSA for Fail Safe operation, or FSE for Fail Secure operation, add \$432.00 List.

PULL TRIM					
Description	Specify			626, 630	605, 625, 629
	Model number	Device type	Finish		
Dummy Trim	512DT	[R, V, M, or C]	[Finish]	\$283.00	\$429.00

DELTA TRIM					
Description	Specify			695	605, 622, 619, 625, 626, 629, 643e
	Model number	Device type	Finish		
Dummy Trim	717DT	[R, V, M, or C]	[Finish]	\$313.00	\$364.00
Night Latch Less Pull <sup>1</sup>	718C	C	[Finish]	\$255.00	\$279.00

1. Available in 622 and 643e.

605	606	612	613	619	622	625	626
US3	US4	US10	US10B	US15	US19	US26	US26D
628	629	630	643E	689	695	710	711
US28	US32	US32D	US11	SP28	SP313	313AN	DC35

## 19 SERIES

### 19-R Series Rim Panic Device

- 3' device pricing shown. 4' add \$26.00 list.

Product	Trim/Control	689	695	630
19-R-EO	N/A	\$394.00	\$394.00	\$694.00
19-R-DT	920DT <sup>1</sup>	\$448.00	\$448.00	\$748.00
19-R-NL	920NL <sup>1</sup>	\$487.00	\$487.00	\$787.00
19-R-EO	930EO <sup>2</sup>	\$440.00	\$440.00	\$740.00
19-R-DT	930DT <sup>2</sup>	\$448.00	\$448.00	\$748.00
19-R-NL	930NL	\$467.00	\$467.00	\$767.00
19-R-C	930C	\$458.00	\$458.00	\$758.00
19-R-DT	917DT	\$436.00	\$436.00	\$736.00
19-R-DT	918DT	\$546.00	\$546.00	\$974.00
19-R-NL	918NL	\$546.00	\$546.00	\$974.00
19-R-K	911K	\$546.00	\$546.00	\$974.00
19-R-K-BE	911K-BE	\$546.00	\$546.00	\$974.00
19-R-K-NL	911K-NL	\$546.00	\$546.00	\$974.00
19-R-L	912L	\$606.00	\$606.00	\$1,020.00
19-R-L-BE	912L-BE	\$606.00	\$606.00	\$1,020.00
19-R-L-NL	912L-NL	\$606.00	\$606.00	\$1,020.00
19-R-L-DT	912L-DT	\$606.00	\$606.00	\$1,020.00
19-R-KIL	914KIL-KD W/CYL	\$650.00	\$650.00	\$950.00
19-R-KIL-NL	914KIL-NL-KD W/CYL	\$650.00	\$650.00	\$950.00
19-R-KIL-BE	914KIL-BE	\$650.00	\$650.00	\$950.00
19-R-KIL-IC	914KIL-IC W/CYL	\$711.00	\$711.00	\$1,011.00

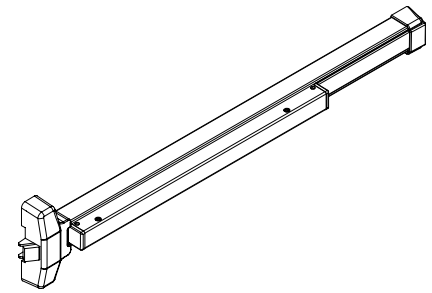

Falcon 19 Series

### F-19-R Series Rim Fire Exit Hardware

- 3' device pricing shown. 4' add \$26.00 list.

Product	Trim/Control	689	695	630
F-19-R-EO	N/A	\$495.00	\$495.00	\$812.00
F-19-R-DT	920DT <sup>1</sup>	\$549.00	\$549.00	\$866.00
F-19-R-NL	920NL <sup>1</sup>	\$588.00	\$588.00	\$905.00
F-19-R-EO	930EO <sup>2</sup>	\$541.00	\$541.00	\$858.00
F-19-R-DT	930DT <sup>2</sup>	\$549.00	\$549.00	\$866.00
F-19-R-NL	930NL	\$568.00	\$568.00	\$885.00
F-19-R-C	930C	\$559.00	\$559.00	\$876.00
F-19-R-DT	917DT	\$537.00	\$537.00	\$854.00
F-19-R-DT	918DT	\$647.00	\$647.00	\$1,092.00
F-19-R-NL	918NL	\$647.00	\$647.00	\$1,092.00
F-19-R-K	911K	\$647.00	\$647.00	\$1,092.00
F-19-R-K-BE	911K-BE	\$647.00	\$647.00	\$1,092.00
F-19-R-K-NL	911K-NL	\$647.00	\$647.00	\$1,092.00
F-19-R-L	912L	\$707.00	\$707.00	\$1,138.00
F-19-R-L-BE	912L-BE	\$707.00	\$707.00	\$1,138.00
F-19-R-L-NL	912L-NL	\$707.00	\$707.00	\$1,138.00
F-19-R-L-DT	912L-DT	\$707.00	\$707.00	\$1,138.00
F-19-R-KIL	914KIL-KD W/CYL	\$751.00	\$751.00	\$1,068.00
F-19-R-KIL-NL	914KIL-NL-KD W/CYL	\$751.00	\$751.00	\$1,068.00
F-19-R-KIL-BE	914KIL-BE	\$751.00	\$751.00	\$1,068.00
F-19-R-KIL-IC	914KIL-IC W/CYL	\$812.00	\$812.00	\$1,129.00

<sup>1</sup> Must specify handing.

<sup>1</sup> These devices are handed and field reversible. RHR handing is furnished standard when handing is not specified.

<sup>2</sup> 930 Series trim is available in 695 (SP313) and 630 (US32D) finish only. 19 Series devices ordered in 689 (SP28) paired with 930 trim are supplied with 630 (US32D) finish trim.

#### DEFAULT ATTRIBUTES

Pricing includes default options shown below. Additional options and configurations available.

Cylinders	Sex bolts	Strike(s)	Door thickness	Center line
Not included	Included	F570	1-3/4"	40-5/16"

605	606	612	613	619	622	625	626
US3	US4	US10	US10B	US15	US19	US26	US26D
628	629	630	643E	689	695	710	711
US28	US32	US32D	US11	SP28	SP313	313AN	DC35

## 19 SERIES

### 19-V Series Surface Vertical Rod Panic Device 🐾

- 3' device pricing shown. 4' add \$26.00 list.

Series	Trim/Control	689	695	630
19-V-EO	N/A	\$618.00	\$618.00	\$1,147.00
19-V-DT	920DT <sup>1</sup>	\$672.00	\$672.00	\$1,201.00
19-V-NL	920NL <sup>1</sup>	\$711.00	\$711.00	\$1,240.00
19-V-EO	930EO <sup>2</sup>	\$664.00	\$664.00	\$1,193.00
19-V-DT	930DT <sup>2</sup>	\$672.00	\$672.00	\$1,201.00
19-V-NL	930NL	\$691.00	\$691.00	\$1,220.00
19-V-C	930C	\$682.00	\$682.00	\$1,211.00
19-V-DT	917DT	\$660.00	\$660.00	\$1,189.00
19-V-DT	918DT	\$770.00	\$770.00	\$1,427.00
19-V-NL	918NL	\$770.00	\$770.00	\$1,427.00
19-V-K	911K	\$770.00	\$770.00	\$1,427.00
19-V-K-BE	911K-BE	\$770.00	\$770.00	\$1,427.00
19-V-K-NL	911K-NL	\$770.00	\$770.00	\$1,427.00
19-V-L	912L	\$830.00	\$830.00	\$1,473.00
19-V-L-BE	912L-BE	\$830.00	\$830.00	\$1,473.00
19-V-L-NL	912L-NL	\$830.00	\$830.00	\$1,473.00
19-V-L-DT	912L-DT	\$830.00	\$830.00	\$1,473.00
19-V-KIL	914KIL-KD W/CYL	\$874.00	\$874.00	\$1,403.00
19-V-KIL-NL	914KIL-NL-KD W/CYL	\$874.00	\$874.00	\$1,403.00
19-V-KIL-BE	914KIL-BE	\$874.00	\$874.00	\$1,403.00
19-V-KIL-IC	914KIL-IC W/CYL	\$935.00	\$935.00	\$1,464.00

### F-19-V Series Surface Vertical Rod Exit Hardware 🐾

- 3' device pricing shown. 4' add \$26.00 list.

Series	Trim/Control	689	695	630
F-19-V-EO	N/A	\$773.00	\$773.00	\$1,295.00
F-19-V-DT	920DT <sup>1</sup>	\$827.00	\$827.00	\$1,349.00
F-19-V-NL	920NL <sup>1</sup>	\$866.00	\$866.00	\$1,388.00
F-19-V-EO	930EO <sup>2</sup>	\$819.00	\$819.00	\$1,341.00
F-19-V-DT	930DT <sup>2</sup>	\$827.00	\$827.00	\$1,349.00
F-19-V-NL	930NL	\$846.00	\$846.00	\$1,368.00
F-19-V-C	930C	\$837.00	\$837.00	\$1,359.00
F-19-V-DT	917DT	\$815.00	\$815.00	\$1,337.00
F-19-V-DT	918DT	\$925.00	\$925.00	\$1,575.00
F-19-V-NL	918NL	\$925.00	\$925.00	\$1,575.00
F-19-V-K	911K	\$925.00	\$925.00	\$1,575.00
F-19-V-K-BE	911K-BE	\$925.00	\$925.00	\$1,575.00
F-19-V-K-NL	911K-NL	\$925.00	\$925.00	\$1,575.00
F-19-V-L	912L	\$985.00	\$985.00	\$1,621.00
F-19-V-L-BE	912L-BE	\$985.00	\$985.00	\$1,621.00
F-19-V-L-NL	912L-NL	\$985.00	\$985.00	\$1,621.00
F-19-V-L-DT	912L-DT	\$985.00	\$985.00	\$1,621.00
F-19-V-KIL	914KIL-KD W/CYL	\$1,029.00	\$1,029.00	\$1,551.00
F-19-V-KIL-NL	914KIL-NL-KD W/CYL	\$1,029.00	\$1,029.00	\$1,551.00
F-19-V-KIL-BE	914KIL-BE	\$1,029.00	\$1,029.00	\$1,551.00
F-19-V-KIL-IC	914KIL-IC W/CYL	\$1,090.00	\$1,090.00	\$1,612.00

🐾 19-V/F-19-V device is handed and field reversible. Trims are furnished RHR when handing is not specified.

- 1 Must specify handing.
- 2 930 Series trim is available in 695 (SP313) and 630 (US32D) finish only. 19 Series devices ordered in 689 (SP28) paired with 930 trim are supplied with 630 (US32D) finish trim.

#### DEFAULT ATTRIBUTES

Pricing includes default options shown below. Additional options and configurations available.

Cylinders	Sex bolts	Strike(s)	Door thickness	Center line
Not included	Included on F-19-V only	3788 & 2130	1-3/4"	40-5/16"

**Extension rods:** For door heights over 7'0" up to 8'0", 12" extension rods are furnished at no additional charge at the time of device order. For door heights over 8'0" up to 10'0" extension rods are furnished at prices shown in parts section with the device at the time of order. Must specify door height on order line.

605	606	612	613	619	622	625	626
US3	US4	US10	US10B	US15	US19	US26	US26D
628	629	630	643E	689	695	710	711
US28	US32	US32D	US11	SP28	SP313	313AN	DC35

**19 SERIES**    OPTIONS

SEX BOLTS	Quantity	Price adjustment
	2729	
19-V	6	\$102.00

Three 4122 Sex Bolts are supplied standard no charge, one for hinge side mounting and two for center case mounting.  
Six 2729 are supplied for additional latch case mounting when device is used with wood, composite or non-reinforced hollow metal doors.

LESS BOTTOM ROD (LBR Fire-Rated Devices must be ordered in pairs, and one Auxiliary Fire Pin (AFL) is furnished per pair.)	Specify (Suffix)	Price adjustment
<ul style="list-style-type: none"> <li>Less bottom rod available with UL Fire Label at no additional charge on F-19-V devices. (F-19-V-LBR requires handing.)</li> <li>For panic devices, deduct -\$74.00 list</li> </ul>	LBR	No charge

CYLINDER DOGGING - NOT FOR USE WITH FIRE EXIT HARDWARE	Specify (Prefix)	Price adjustment
Cylinder dogging available on all 19 Series panic devices.	CD	\$90.00
Less dogging available on all 19 Series panic devices.	LD	No charge

ACCESSIBLE DEVICE	Specify (Suffix)	Price adjustment
<ul style="list-style-type: none"> <li>Accessible device compliant with the California Building Code (Section 11B-309.4) requirement for 5 lb. maximum operational force.</li> <li>Available on 3' and 4' AX-19-R, AX-F-19-R, AX-19-V, AX-F-19-V, AX-19-V-LBR, AX-F-19-V-LBR/LBR-AFL.</li> <li>Trim functions available EO, DT, NL, L, L-BE, L-NL, L-DT, C, KIL, KIL-BE, KIL-NL, and KIL-IC.</li> </ul>	AX	\$35.00

19 SERIES

TRIM

605	606	612	613	619	622	625	626
US3	US4	US10	US10B	US15	US19	US26	US26D
628	629	630	643E	689	695	710	711
US28	US32	US32D	US11	SP28	SP313	313AN	DC35

- Cylinders are not included in the price.
- 920 Series trim are handed and not field reversible, specify RHR or LHR.
- 911, 912, and 914 Series trim are handed and field reversible. Trims are furnished RHR when handing is not specified.
- 930 Series trim are available in 630 (US32D) and 695 (SP313) finishes only.

TRIDENT TRIM					
Description	Specify			630	689, 695
	Model number	Device type	Finish		
Dummy Trim	920DT	.[R or V]	.[Finish]	-	\$54.00
Night Latch	920NL	.[R or V]	.[Finish]	-	\$93.00

CENTRON TRIM					
Description	Specify			630, 695	689
	Model number	Device type	Finish		
Dummy Trim	917DT	.[R or V]	.[Finish]	\$42.00	\$42.00
Exit Only	930EO	.[R or V]	.[Finish]	\$46.00	-
Dummy Trim	930DT	.[R or V]	.[Finish]	\$54.00	-
Night Latch	930NL	.[R or V]	.[Finish]	\$73.00	-
Night Latch Less Pull	930C	.[R or V]	.[Finish]	\$64.00	-

CONTROL TRIM					
Description	Specify			619	689, 695
	Model number	Device type	Finish		
Dummy Trim	918DT	.[R or V]	.[Finish]	\$280.00	\$152.00
Night Latch	918NL	.[R or V]	.[Finish]	\$280.00	\$152.00
Knob, Key Locks or Unlocks	911K	.[R or V]	.[Finish]	\$280.00	\$152.00
Knob, Blank Escutcheon	911K-BE	.[R or V]	.[Finish]	\$280.00	\$152.00
Knob, Night Latch	911K-NL	.[R or V]	.[Finish]	\$280.00	\$152.00

LEVER TRIM					
Description	Specify			619	689, 695
	Model number	Device type	Finish		
Dane Lever, Key Locks or Unlocks	912L	.[R or V]	.[Finish]	\$326.00	\$212.00
Dane Lever, Blank Escutcheon	912L-BE	.[R or V]	.[Finish]	\$326.00	\$212.00
Dane Lever, Night Latch	912L-NL	.[R or V]	.[Finish]	\$326.00	\$212.00
Dane Lever, Dummy Trim	912L-DT	.[R or V]	.[Finish]	\$326.00	\$212.00

KEY-IN-LEVER TRIMS					
Description	Specify			630, 695	
	Model number	Device type	Finish		
Dane Key-in-lever, with Keyed Different Cylinder	914KIL-KD	.[R or V]	.[Finish]	\$256.00	
Dane Key-in-lever, Blank Escutcheon	914KIL-BE	.[R or V]	.[Finish]	\$256.00	
Dane Key-in-lever, Night Latch with Cylinder	914KIL-NL-KD	.[R or V]	.[Finish]	\$256.00	
Dane Key-in-lever with IC Core Cylinder	914KIL-IC	.[R or V]	.[Finish]	\$317.00	

1. 914 KIL-KD, KIL-NL-KD come standard with a C keyway and 914 KIL-IC come standard with a A keyway.
2. Consult factory if other keyways are desired to order separately.

<b>605</b>	<b>606</b>	<b>612</b>	<b>613</b>	<b>619</b>	<b>622</b>	<b>625</b>	<b>626</b>
US3	US4	US10	US10B	US15	US19	US26	US26D
<b>628</b>	<b>629</b>	<b>630</b>	<b>643E</b>	<b>689</b>	<b>695</b>	<b>710</b>	<b>711</b>
US28	US32	US32D	US11	SP28	SP313	313AN	DC35

## 1690 SERIES

### 1690 Series Concealed Vertical Rod Exit Device

- All devices are priced for 30", 36" x 7' aluminum or hollow metal doors

Series	Default trim (included)	625	626
1690-EO	N/A	\$870.00	\$836.00
1691-DT	9970 Pull	\$1,348.00	\$1,314.00
1692-NL-OP	169CA with rim cylinder	\$1,043.00	\$1,009.00
1692-HB-OP	169CA with rim cylinder	\$1,043.00	\$1,009.00
1694-NL-P	9970 Pull 169CA with rim cylinder	\$1,521.00	\$1,487.00
1694-HB-P	9970 Pull 169CA with rim cylinder	\$1,521.00	\$1,487.00

- Devices are supplied 36" x 7' standard, if not specified.
- Price includes PB48 Strike.
- Hex bottom latch furnished standard.
- NL/HB trim function is supplied with a C keyway cylinder.

#### DEFAULT ATTRIBUTES

Pricing includes default options shown below. Additional options and configurations available.

Cylinders	Strike(s)	Door thickness	Center line
Not included	PB48 Strike Included	1-3/4"	40-9/16"

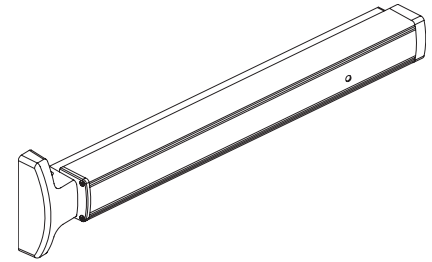

Falcon 1690 Series

## 1790 SERIES

### 1790 Series Rim Exit Device

- All devices are priced for 30" and 36" aluminum or hollow metal doors

Series	Default trim (included)	628	626
1790-EO	N/A	\$812.00	\$782.00
1791-DT	9970 Pull	\$1,290.00	\$1,260.00
1792-NL-OP	179CA with rim cylinder	\$985.00	\$955.00
1792-HB-OP	179CA with rim cylinder	\$985.00	\$955.00
1794-NL-P	9970 Pull 179CA with rim cylinder	\$1,463.00	\$1,433.00
1794-HB-P	9970 Pull 179CA with rim cylinder	\$1,463.00	\$1,433.00

- Devices are supplied 36" x 7' standard, if not specified.
- Price includes TD35 Strike.
- NL/HB trim function is supplied with a C keyway cylinder.

#### DEFAULT ATTRIBUTES

Pricing includes default options shown below. Additional options and configurations available.

Cylinders	Strike(s)	Door thickness	Center line
Not included	TD35 Strike Included	1-3/4"	40-9/16"

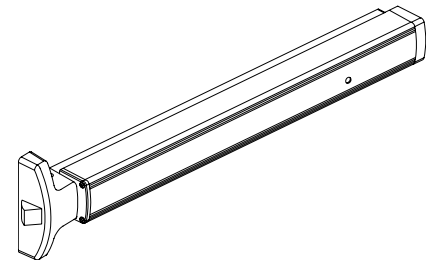

Falcon 1790 Series



605	606	612	613	619	622	625	626
US3	US4	US10	US10B	US15	P35	US26	US26D
628	629	630	643E	689	695	710	711
US28	US32	US32D	US11	P28	P13	DC13	DC35

**1690/1790 SERIES**    **OPTIONS**

SWITCHES	Specify (Prefix)	Price adjustment
RX Switch ▪ Base exit device unit modified Request-to-Exit switch monitoring pushpad	RX	\$310.00

LATCH RETRACTION	Specify (Prefix)	Price adjustment
Motorized electric latch retraction	MEL	\$980.00

EXTRA LENGTH	Specify (Suffix)	Price adjustment
42" 1690/1790 Device	42"	\$26.00
48" 1690/1790 Device	48"	\$36.00

1690 SERIES OPTIONAL LATCHES	Specify (Suffix)	Price adjustment
Rod bottom latch	RL	\$40.00
Pullman bottom latch	PL	\$40.00
Top latch for use with electric strikes ▪ Device furnished LBR (Less bottom rod and Less strike) Deduct -\$35.00 List	ES	\$44.00
For retrofit of 1690 device	Less Rods	-\$64.00

1690 SERIES HURRICANE DEVICE - Available up to 8' device only	Specify (Prefix)	Price adjustment
Hurricane option ▪ HH is for a Hurricane device for all door manufacturers other than YKK	HH	\$158.00
Hurricane option ▪ HH is for a Hurricane device for door manufacturer YKK	HHYKK	\$158.00

HH (Hurricane) 1690 devices are hurricane rated by specific door manufacturers. Consult your device manufacturer to assure the HH1690 is hurricane rated with their door solution.

1690 SERIES NON-STANDARD DOOR HEIGHT - For doors greater than 7'	Specify	Price adjustment
Up to 8'	8ft	\$92.00
Up to 9'	9ft	\$115.00
Up to 10'	10ft	\$134.00

1790 SERIES LEVER CONTROL					
Description	Specify			622, 689, 695	619
	Model number	Handing	Finish		
Lever Control	179L	.[RHR or LHR]	.[Finish]	\$466.00	\$522.00
Lever Control, Blank Escutcheon	179L-BE	.[RHR or LHR]	.[Finish]	\$466.00	\$522.00
Lever Control, Night Latch	179L-NL	.[RHR or LHR]	.[Finish]	\$466.00	\$522.00

- ☞ Lever controls are handed. Specify handing RHR or LHR.
- 1. 179L Trims are field retrofittable with all 1790 Series devices.
- 2. For initial installation requiring lever trim, the 1790EO is the suggested device to order with the 179L trims.
- 3. 179L and L-NL require a 1-1/8" mortise cylinder with straight cam, sold separately.

<b>605</b>	<b>606</b>	<b>612</b>	<b>613</b>	<b>619</b>	<b>622</b>	<b>625</b>	<b>626</b>
US3	US4	US10	US10B	US15	US19	US26	US26D
<b>628</b>	<b>629</b>	<b>630</b>	<b>643E</b>	<b>689</b>	<b>695</b>	<b>710</b>	<b>711</b>
US28	US32	US32D	US11	SP28	SP313	313	DC35

## 1990 SERIES

### 1990 Series Concealed Vertical Rod Exit Device

- All devices are priced for 3'8" x 7' aluminum or hollow metal doors

Series	Default trim (included)	626
1990-EO	N/A	\$1,751.00
1991-DT	9970 Pull	\$2,229.00
1992-NL-OP	Rim cylinder only	\$1,884.00
1992-HB-OP	Rim cylinder only	\$1,884.00
1993-NL <sup>3</sup>	9970 with rim cylinder	\$2,362.00
1993-HB <sup>3</sup>	9970 with rim cylinder	\$2,362.00

- Devices are supplied 3' 8" x 7' standard, if not specified.
- Hex bottom latch furnished standard.
- NL/HB trim function is supplied with a C keyway cylinder.

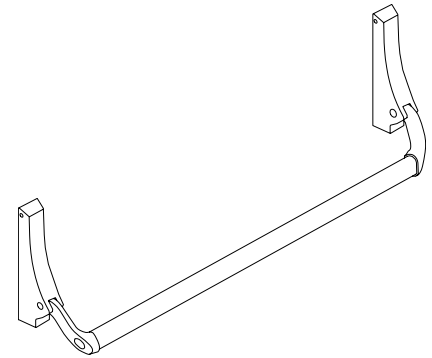

Falcon 1990 Series

#### DEFAULT ATTRIBUTES

Pricing includes default options shown below. Additional options and configurations available.

Cylinders	Strike(s)	Door thickness	Center line
Not included	PB48 Strike Included	1-3/4"	40-9/16"

## 2090 SERIES

### 2090 Series Rim Exit Device

- All devices are priced for 3'8" aluminum or hollow metal doors

Series	Default trim (included)	626
2090-EO	N/A	\$1,625.00
2091-DT	9970 Pull	\$2,103.00
2092-NL-OP	Rim cylinder only	\$1,758.00
2092-HB-OP	Rim cylinder only	\$1,758.00
2093-NL <sup>2</sup>	9970 with rim cylinder	\$2,236.00
2093-HB <sup>2</sup>	9970 with rim cylinder	\$2,236.00

- Price includes SD36 Strike.
- NL/HB trim function is supplied with a C keyway cylinder.

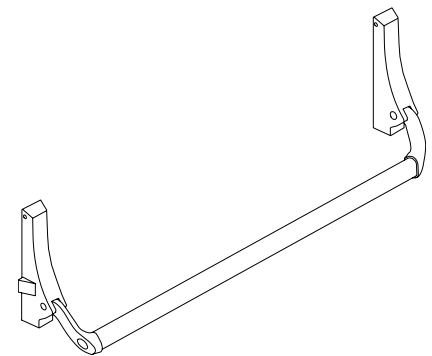

Falcon 2090 Series

#### DEFAULT ATTRIBUTES

Pricing includes default options shown below. Additional options and configurations available.

Cylinders	Strike(s)	Door thickness	Center line
Not included	SD36 Strike Included	1-3/4"	40-9/16"

605	606	612	613	619	622	625	626
US3	US4	US10	US10B	US15	US19	US26	US26D
628	629	630	643E	689	695	710	711
US28	US32	US32D	US11	SP28	SP313	313	DC35

**1990/2090 SERIES** OPTIONS

1990 SERIES OPTIONAL LATCHES	Specify (Suffix)	Price adjustment
Rod bottom latch	RL	\$40.00
Pullman bottom latch	PL	\$40.00
Top latch for use with electric strikes ▪ Device furnished LBR (Less bottom rod and Less strike) Deduct -\$35.00 List	ES	\$44.00

NON-STANDARD DOOR HEIGHT - For doors greater than 7'	Specify	Price adjustment
Up to 8'	8ft	\$92.00
Up to 9'	9ft	\$115.00
Up to 10'	10ft	\$134.00

CROSSBAR	Specify	Price adjustment
Crossbar furnished 41" standard - Easily cut for job fitting		
Extra length crossbar - 48" (fits door width up to 51") - 622, 689, 695 finishes	.[Finish]	\$29.00
Extra length crossbar - 48" (fits door width up to 51") - Architectural finishes	.[Finish]	\$40.00
Less crossbar	-	-\$167.00

☞ Specify handing RHR or LHR for 2090 Series. Not reversible.  
Specify if door material other than aluminum.  
1990 Series not recommended for use on wood doors.

622	689	695
MTBLK	ALUM	DKBRZ

SURFACE DOOR CLOSERS ■ LCN

**1250 Series**

- Light duty cast aluminum door closer
- Adjustable sizes 1–5
- ANSI/BHMA 156.4, Grade 1 certified
- Closers without Hold-Open arms are UL 10C fire rated

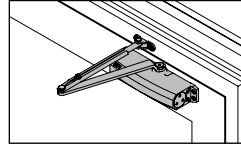

Series	Arm function	Handing	Cylinder	Cover	Price			
					622	689	695	
1250	☺	RWPA	N/A	CYL	LESSCOV	\$310.00		
1250	☺	RWPA	N/A	CYL	SLIMPC	\$331.00		
1250	☺	HWPA	N/A	CYL	LESSCOV	\$352.00		
1250	☺	HWPA	N/A	CYL	SLIMPC	\$373.00		

**1260 Series**

- Light-medium duty cast iron door closer
- Adjustable sizes 1–5
- ANSI/BHMA 156.4, Grade 1 certified
- Closers without Hold-Open arms are UL 10C fire rated

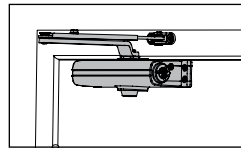

Series	Arm function	Handing	Cylinder	Cover	Price			
					622	689	695	
1261	☺	RWPA	N/A	CYL	LESSCOV	\$430.00		
1261	☺	HWPA	N/A	CYL	LESSCOV	\$473.00		

All 1260 Series closers ship with Thru Bolt, Self Reaming and Tapping Screws (TBSRT).

**1450 Series**

- Medium duty cast aluminum door closer
- Adjustable sizes 1–6
- ANSI/BHMA 156.4, Grade 1 certified
- Closers without Hold-Open arms are UL 10C fire rated

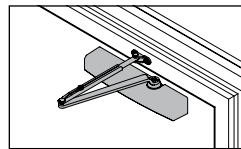

Series	Arm function	Handing	Cylinder	Cover	Price			
					622	689	695	
1450	☺	RWPA	N/A	CYL	SLIMPC	\$409.00		
1450	☺	RWPA	N/A	CYL	FPC	\$425.00		
1450	☺	HWPA	N/A	CYL	SLIMPC	\$451.00		
1450	☺	HWPA	N/A	CYL	FPC	\$467.00		

Notes: **622** = Matte black finish (MTBLK); **689** = Aluminum finish (AL); **695** = Dark bronze finish (DKBRZ)  
**RWPA** = Regular arm with parallel arm bracket; **HWPA** = Hold open arm with parallel arm bracket  
 (Please note hold open arm configurations are not UL listed.)

622	689	695
MTBLK	ALUM	DKBRZ

**1460 Series**

- Medium duty cast iron door closer
- Adjustable sizes 1–6
- ANSI/BHMA 156.4, Grade 1 certified
- Closers without Hold-Open arms are UL 10C fire rated

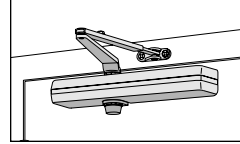

Series	Arm function	Handing	Cylinder	Cover	Price			
					622	689	695	
1461	☺	RWPA	N/A	CYL	SLIMPC	\$539.00		
1461	☺	RWPA	N/A	CYL	FPC	\$555.00		
1461	☺	HWP	N/A	CYL	SLIMPC	\$582.00		
1461	☺	HWP	N/A	CYL	FPC	\$598.00		

All 1460 Series closers ship with TBSRT. SLIMPC cover is default.

**4040XP Series**

- Heavy duty cast iron door closer
- Adjustable sizes 1–6
- ANSI/BHMA 156.4, Grade 1 certified
- Closers without Hold-Open arms are UL 10C fire rated

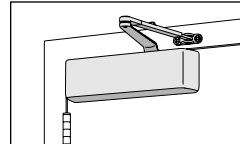

Series	Arm function	Handing	Cylinder	Cover	Price			
					622	689	695	
4040XP	☺	RWPA	N/A	CYL	PC	\$765.00		
4040XP	☺	HWP	N/A	CYL	PC	\$860.00		
4040XP	☺	EDA	N/A	CYL	PC	\$824.00		
4040XP	☺	CUSH	N/A	CYL	PC	\$867.00		
4040XP	☺	SCUSH	N/A	CYL	PC	\$976.00		

All 4040XP Series closers ship with Thru Bolt, Self Reaming and Tapping Screws (TBSRT).

**4050A Series**

- Heavy duty cast aluminum door closer
- Adjustable sizes 1–6
- ANSI/BHMA 156.4, Grade 1 certified
- Closers without Hold-Open arms are UL 10C fire rated

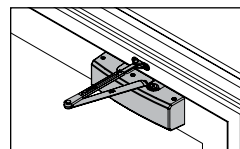

Series	Arm function	Handing	Cylinder	Cover	Price			
					622	689	695	
4050A	☺	RWPA	N/A	CYL	PC	\$637.00		
4050A	☺	HWP	N/A	CYL	PC	\$732.00		
4050A	☺	EDA	N/A	CYL	PC	\$694.00		
4050A	☺	CUSH	N/A	CYL	PC	\$737.00		
4050A	☺	SCUSH	N/A	CYL	PC	\$844.00		

Notes: **622** = Matte black finish (MTBLK); **689** = Aluminum finish (AL); **695** = Dark bronze finish (DKBRZ)

**RWPA** = Regular arm with parallel arm bracket; **HWP** = Hold open arm with parallel arm bracket  
(Please note hold open arm configurations are not UL listed.)

**EDA** = Extra Duty Parallel Arm; **CUSH** = Cush-n-stop; **SCUSH** = Spring cush-n-stop

622	689	695
MTBLK	ALUM	DKBRZ

Parts and components

Series	Part number	Product description	Price		
			622	689	695
1250	18	Drop Plate	\$85.00		
1250	18PA	Drop Plate - PA	\$85.00		
1260	18	Drop Plate	\$86.00		
1260	18PA	Drop Plate - PA	\$86.00		
1450	18	Drop Plate	\$85.00		
1450	18PA	Drop Plate - PA	\$85.00		
1450	18FC	Drop Plate (for Full Cover)	\$85.00		
1450	18PAFC	Drop Plate - PA (for Full Cover)	\$85.00		
1460	18	Drop Plate	\$86.00		
1460	18PA	Drop Plate - PA	\$86.00		
1460	18FC	Drop Plate (for Full Cover)	\$86.00		
1460	18PAFC	Drop Plate - PA (for Full Cover)	\$86.00		
4050A	18	Drop Plate	\$85.00		
4050A	18PA	Drop Plate PA	\$85.00		

Notes: **622** = Matte black finish (MTBLK); **689** = Aluminum finish (AL); **695** = Dark bronze finish (DKBRZ)

**RWPA** = Regular arm with parallel arm bracket; **HWP**A = Hold open arm with parallel arm bracket  
 (Please note hold open arm configurations are not UL listed.)

**EDA** = Extra Duty Parallel Arm; **CUSH** = Cush-n-stop; **SCUSH** = Spring cush-n-stop

628	622	689	695	710
ANCLR	MTBLK	ALUM	DKBRZ	ANDKB

## AUTOMATIC OPERATORS

### 4600 Series Auto equalizer

- Heavy duty electro hydraulic automatic operator
- Used when door is operated manually most of the time with occasional automatic opening
- ANSI/BHMA 156.19, UL 10C, UL 325

Series	Mounting	Arm function	Finish	Handing	Cylinder assembly	Cover	Price
4630	-	STDTRKARM	689	N/A	CYL	MC	\$8,671.00
4630	-	STDTRKARM	695	N/A	CYL	MC	\$8,671.00
4642	-	REGARM	689	N/A	CYL	MC	\$8,560.00
4642	-	REGARM	695	N/A	CYL	MC	\$8,560.00

### 9100 Series Benchmark

- Medium duty electromechanical automatic operator
- Used when door is operated electronically most of the time
- ANSI/BHMA 156.19, UL 325

Series	Mounting	Arm function	Finish	Handing	Cylinder assembly	Cover	Price
9130	-	STDTRKARM	628	N/A	CYL	MC	\$5,218.00
9130	-	STDTRKARM	710	N/A	CYL	MC	\$5,218.00
9140	-	REGARM	628	N/A	CYL	MC	\$5,118.00
9140	-	REGARM	710	N/A	CYL	MC	\$5,118.00

### 9500 Series Senior swing

- Heavy duty electromechanical automatic operator
- Used when door is operated electronically most of the time
- ANSI/BHMA 156.19, UL 325, UL 10C

Series	Mounting	Arm function	Finish	Handing	Cylinder assembly	Cover	Price
9530	-	STDTRKARM	628	RH	CYL	MC	\$7,344.00
9530	-	STDTRKARM	628	LH	CYL	MC	\$7,344.00
9530	-	STDTRKARM	710	RH	CYL	MC	\$7,344.00
9530	-	STDTRKARM	710	LH	CYL	MC	\$7,344.00
9540	-	REGARM	628	RH	CYL	MC	\$7,219.00
9540	-	REGARM	628	LH	CYL	MC	\$7,219.00
9540	-	REGARM	710	RH	CYL	MC	\$7,219.00
9540	-	REGARM	710	LH	CYL	MC	\$7,219.00

## General closer information

### Surface mount SC Series

#### Certifications and listings

- SC60A, SC70A and SC80A Series closers are certified to meet the requirements of ANSI Standard A156.4, Grade 1.
- SC90A Series closers are certified to meet the requirements of ANSI Standard A156.4, Grade 3.
- SC60A, SC70A, SC80A, and SC90A Series closers without hold-open arms are UL10C Fire-rated
- SC61A, SC71A, SC81A, and SC91A Series are designed to meet the American Disabilities Act (ADA) and ANSI A117.1
- SC93A (spring size 3) and SC94A (spring size 4) Series do not meet ADA force requirements.

#### Covers and hardware:



- SC80A Series closers ship with a standard SLIM cover unless an optional FULL (FC) cover is added to the order line.
- SC60A Series closers ship as LESS cover unless an optional SLIM cover is added to the order line.
- SC90A Series closers ship LESS cover unless an option SLIM cover is added to order line.
- All SC60A/70A/80A/93A/94A closer series are furnished with TBWMS and self-reaming and tapping screws.

#### Master cartons

- SC90A Series closers are packed with six (6) identical closers per master carton. SC60A and SC80A RWPA are packed with six (6) identical closers per master carton. SC60A and SC80A HWPA, DS, DSHO, HD, SS, and SSHO arms are packed 4 per master carton.
- SC70A Series closers are packed with four (4) identical closers per master carton.

## Finish codes and descriptions

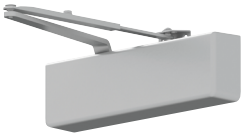
BHMA code		Description
622	(MTBK)	Matte Black
689	(AL)	Silver Painted (Resembles Aluminum Finish)
695	(DKBRZ)	Dark Bronze Painted (Spray Duranodic)

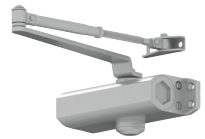
	SERIES	DUTY	APPLICATIONS
	<b>SC70A Series</b>	Heavy	<ul style="list-style-type: none"> <li>▪ Commercial/exterior door</li> <li>▪ Commercial/interior door</li> <li>▪ Aluminum store front</li> </ul>
	<b>SC80A Series</b>	Medium	<ul style="list-style-type: none"> <li>▪ Commercial/exterior door</li> <li>▪ Commercial/interior door</li> <li>▪ Aluminum store front</li> </ul>
	<b>SC60A Series</b>	Light-Medium	<ul style="list-style-type: none"> <li>▪ Commercial/exterior door</li> <li>▪ Commercial/interior door</li> <li>▪ Aluminum store front</li> </ul>
	<b>SC90A Series</b>	Light	<ul style="list-style-type: none"> <li>▪ Commercial/interior door</li> <li>▪ Aluminum store front</li> </ul>



## SURFACE DOOR CLOSERS ■ FALCON

### SC Series Options overview

Falcon has several options to meet your unique application and/or installation needs. See the options section on each series page in the Falcon Closer price list for available options by Series. Please contact **Falcon Closer Customer Care at (877) 671-7011** for additional information. As always, we appreciate your business!

#### CYLINDER OPTIONS

- **STD - Standard cylinder.** Cylinder will provide consistent door control throughout the opening and closing cycle. Independent backcheck, main speed and latch speed are field adjustable regulation valves and incorporated into the cylinder.
- **CYLDEL - Delay action cylinder.** Cylinder will provide consistent door control throughout the opening and closing cycle but includes an extra regulation valve that allows the door to slowly close (delay) as it begins to send the door back to latch (approximately 70°). Independent backcheck, main speed and latch speed are field adjustable regulation valves and incorporated into the cylinder.

#### COVER OPTIONS

- **STD - Standard cover.** Cover will enclose the cylinder body with the exception of the unused pinion shaft. A shaft cover will be included to cover the unused pinion shaft.
- **SLIMCOV - Slim cover.** Cover will enclose the cylinder body with the exception of the unused pinion shaft. A shaft cover will be included to cover the unused pinion shaft.
- **FULLCOV - Full cover.** Cover will enclose the entire cylinder body, including the unused pinion shaft.

#### ARM OPTIONS

- **RWPA - Regular arm with parallel arm bracket.** Includes adjustable forearm assembly to accommodate a variety of door types and frame conditions. Parallel Arm (PA) bracket allows closer to be installed on the 'push' side of the door in a parallel arm type configuration.
- **HWPA - Hold-open arm with parallel arm bracket.** Includes adjustable forearm assembly to accommodate a variety of door types and frame conditions. Parallel Arm (PA) bracket allows closer to be installed on the 'push' side of the door in a parallel arm type configuration. Hold open function adjustable at the arm shoe.
- **HDP A - Heavy duty arm with parallel arm bracket.** Includes a stamped steel main arm and forearm for added durability in potentially high traffic and/or abusive applications. Parallel Arm (PA) bracket is a permanent feature, installation on 'push' side of the door in a parallel arm type configuration is required.
- **FA - Forged arm.** Extra heavy duty arm with parallel arm bracket. Includes a forged steel main arm and forearm for maximum durability in high traffic and/or abusive applications. Parallel Arm (PA) bracket is a permanent feature, installation on 'push' side of the door in a parallel arm type configuration is required.
- **FAHO - Forged arm with hold-open.** Extra heavy duty arm with parallel arm bracket that incorporates a hold open feature. Includes a forged steel main arm and forearm for maximum durability in high traffic and/or abusive applications. Parallel Arm (PA) bracket is a permanent feature, installation on 'push' side of the door in a parallel arm type configuration is required.

- **DS - Dead stop arm.** Heavy duty arm with parallel arm bracket that incorporates a positive mechanical stop. Includes a stamped steel main arm and forearm for added durability in potentially high traffic and/or abusive applications. Parallel Arm (PA) bracket is a permanent feature, installation on 'push' side of the door in a parallel arm type configuration is required.
- **DSHO - Dead stop arm with hold-open.** Heavy duty arm with parallel arm bracket that incorporates a positive mechanical stop and hold open feature. Includes a stamped steel main arm and forearm for added durability in potentially high traffic and/or abusive applications. Parallel Arm (PA) bracket is a permanent feature, installation on 'push' side of the door in a parallel arm type configuration is required. Hold open function is manually selected with a 'thumb turn' feature built into the main portion of the arm.
- **SS - Spring-n-stop arm.** Extra heavy duty arm with parallel arm bracket that incorporates an integral spring stop. Includes a forged steel main arm and forearm for maximum durability in high traffic and/or abusive applications. Parallel Arm (PA) bracket is a permanent feature, installation on 'push' side of the door in a parallel arm type configuration is required.
- **SSHO - Spring-n-stop arm with hold-open.** Extra heavy duty arm with parallel arm bracket that incorporates an integral spring stop and hold open feature. Includes a forged steel main arm and forearm for maximum durability in high traffic and/or abusive applications. Parallel Arm (PA) bracket is a permanent feature, installation on 'push' side of the door in a parallel arm type configuration is required.

#### FASTENER PACK OPTION

- **TBWMS - Through bolt, wood, and machine screws.** Fasteners for installation on wood, hollow metal or aluminum store front type doors. Through bolts for installations on 1-3/4" thick, hollow core doors are included. SC60A/SC70A/SC80A/SC93A/SC94A faster pack will contain TBWMS and self-reaming and tapping screws.

#### ADA ACCESSIBILITY REQUIREMENTS

- **Product Information - Closers are preset for standard spring power or can be adjusted in the field to generate the 5 lbs. of opening force (36" wide, interior door) requirements for ADA (Sections 4.13.10 and/or 4.13.11) and the ANSI Standard A117.1 (Sections 4.13.10 and/or 4.13.11).**
- **Product Information - Closers installed with the delay (CYLDEL) cylinder option will also comply with the additional advisory suggestions for ADA (Section 4.13.10) and ANSI A117.1 (Section 4.13.10).**

## SC SERIES ARM TYPES

RWPA

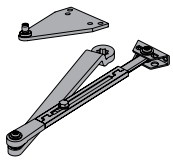

HWPA

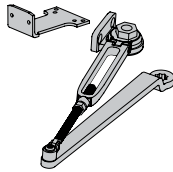

HDP A

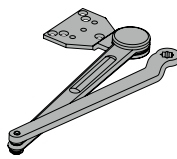

FA

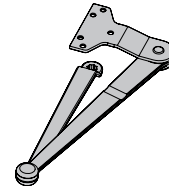

FAHO

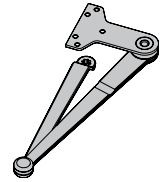

DS

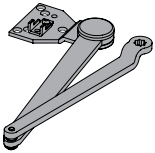

DSHO

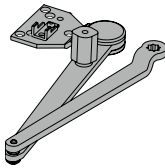

SS

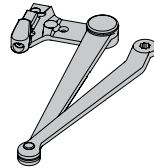

SSHO

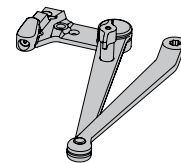

## SC SERIES INSTALLATION ACCESSORIES

Soffit shoe support

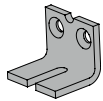

Blade stop spacer

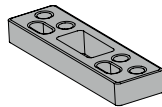

Auxiliary shoe

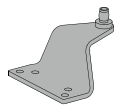

Standard cover

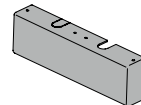

Slim cover

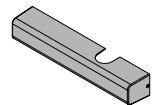

Plate (PA)

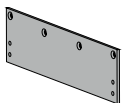

Plate (FC)

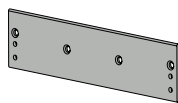
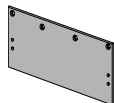

Plate (PAFC)



Pinion cap



622	689	695
MTBLK	ALUM	DKBRZ

### SC60A SERIES SURFACE DOOR CLOSERS

This light- to medium-duty closer is designed for commercial applications like a small boutique or office.

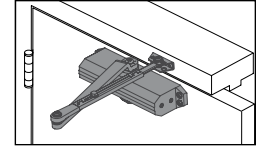

Series	Arm function	Handing	Cylinder	Cover	Price		
					622	689	695
SC61A	♿	RWPA	-	CYL	LESSCOV	\$237.00	
SC61A	♿	HWPA	-	CYL	LESSCOV	\$271.00	
SC61A	♿	HDPA	-	CYL	LESSCOV	\$271.00	
SC61A	♿	DS	-	CYL	LESSCOV	\$299.00	
SC61A	♿	DSHO	-	CYL	LESSCOV	\$331.00	
SC61A	♿	SS	-	CYL	LESSCOV	\$392.00	
SC61A	♿	SSHO	-	CYL	LESSCOV	\$417.00	

SC61A is fully adjustable 1–5.

#### DEFAULT AND COMMON CONFIGURATIONS

Pricing includes default options shown below unless otherwise specified. Specification rules, additional options, and pricing adders are shown in the tables below.

#### Cylinder

Cast Aluminum Cylinder Assembly (CYL)

#### Cover

Less Cover (LESSCOV)

#### Screw package

Through Bolt Self Reaming and Tapping Wood and Machine Screws (TBWMSRT)

#### SPECIFICATION RULES, ADDITIONAL OPTIONS, AND PRICING ADDERS

Order of attributes when placing an order for a non-standard configuration. See parts section for individual parts pricing. Attributes shown in CAPS are required. Other attributes are required only if you are deviating from the product's default.

MODEL . ARM TYPE . FINISH . Cover

COVER	Specify (Suffix)	Price adjustment
Less Cover (LESSCOV) - Default	-	-
Slim Line Plastic Cover	SLIMPC	\$21.00

SC80A SERIES PARTS AND ACCESSORIES	Specify			Price
	Part number	Handing	Finish	
Standard cylinder	FAL.SC61A-3071	-	.[Finish]	\$146.00
Slim cover	FAL.SC60A-72	-	.[Finish]	\$21.00
Regular arm with PA bracket	FAL.SC60A-3077PA	-	.[Finish]	\$92.00
Hold open arm with PA bracket	FAL.SC60A-3049PA	-	.[Finish]	\$126.00
Heavy duty parallel arm	FAL.SC60A-3077HD	-	.[Finish]	\$126.00
Dead stop parallel arm	FAL.SC60A-3077DS	-	.[Finish]	\$149.00
Hold-open dead stop parallel arm	FAL.SC60A-3049DS	-	.[Finish]	\$183.00
Spring-n-stop arm	FAL.SC60A-3077SS	-	.[Finish]	\$245.00
Hold-open Spring-n-stop arm	FAL.SC60A-3049SS	-	.[Finish]	\$274.00
Mounting plate - Top jamb	FAL.SC60A-18	-	.[Finish]	\$45.00
Mounting plate - Push side	FAL.SC60A-18PA	-	.[Finish]	\$45.00
Cush shoe support	FAL.SC60A-30	-	.[Finish]	\$31.00
Blade stop spacer	FAL.SC60A-61	-	.[Finish]	\$35.00
Offset auxiliary shoe	FAL.SC60A-62A	-	.[Finish]	\$40.00

Note: Matte Black (622) and Dark Bronze (695) closers share the same screw finish.

622	689	695
MTBLK	ALUM	DKBRZ

### SC70A SERIES SURFACE DOOR CLOSERS

This heavy-duty closer is designed for busy commercial and institutional applications.

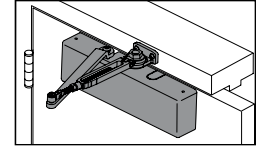

Series	Arm function	Handing	Cylinder	Cover	Price		
					622	689	695
SC71A	⦿	RWPA	-	CYL	FPC	\$466.00	
SC71A	⦿	HWPA	-	CYL	FPC	\$497.00	
SC71A	⦿	HDPA	-	CYL	FPC	\$497.00	
SC71A	⦿	FA	-	CYL	FPC	\$521.00	
SC71A	⦿	FAHO	Handed	CYL	FPC	\$557.00	
SC71A	⦿	DS	-	CYL	FPC	\$523.00	
SC71A	⦿	DSHO	-	CYL	FPC	\$559.00	
SC71A	⦿	SS	-	CYL	FPC	\$620.00	
SC71A	⦿	SSHO	-	CYL	FPC	\$647.00	

SC71A is fully adjustable 1–6.

#### DEFAULT AND COMMON CONFIGURATIONS

Pricing includes default options shown at left unless otherwise specified. Specification rules, additional options, and pricing adders are shown in the tables at left.

#### Cylinder

Cast Aluminum Cylinder Assembly (CYL)

#### Cover

Full Plastic Cover (FPC)

#### Screw package

Through Bolt Self Reaming and Tapping Wood and Machine Screws (TBWMSRT)

SC70A SERIES PARTS AND ACCESSORIES	Specify			Price
	Part number	Handing	Finish	
Standard cylinder	FAL.SC71A-3071	-	.[Finish]	\$349.00
Delay cylinder - not available in Matte Black (622)	FAL.SC71A-3071DEL	-	.[Finish]	\$398.00
Full cover	FAL.SC70A-72	-	.[Finish]	\$26.00
Regular arm with PA bracket	FAL.SC70A-3077PA	-	.[Finish]	\$92.00
Hold open arm with PA bracket	FAL.SC70A-3049PA	-	.[Finish]	\$126.00
Heavy duty parallel arm	FAL.SC70A-3077HD	-	.[Finish]	\$126.00
Forged parallel arm	FAL.SC70A-3077FA	-	.[Finish]	\$147.00
Hold-open forged parallel arm	FAL.SC70A-3049FA	.[Handing]	.[Finish]	\$180.00
Dead stop parallel arm	FAL.SC70A-3077DS	-	.[Finish]	\$149.00
Hold-open dead stop parallel arm	FAL.SC70A-3049DS	-	.[Finish]	\$183.00
Spring-n-stop arm	FAL.SC70A-3077SS	-	.[Finish]	\$245.00
Hold-open Spring-n-stop arm	FAL.SC70A-3049SS	-	.[Finish]	\$274.00
Narrow frame back plate	FAL.SC70A-18	-	.[Finish]	\$79.00
Narrow top rail drop plate	FAL.SC70A-18PA	-	.[Finish]	\$79.00
Cush shoe support	FAL.SC70A-30	-	.[Finish]	\$31.00
Blade stop spacer	FAL.SC70A-61	-	.[Finish]	\$35.00
Offset auxiliary shoe	FAL.SC70A-62A	-	.[Finish]	\$40.00

Note: Matte Black (622) and Dark Bronze (695) closers share the same screw finish.

622	689	695
MTBLK	ALUM	DKBRZ

### SC80A SERIES SURFACE DOOR CLOSERS

This medium-duty closer is designed for residential and commercial applications.

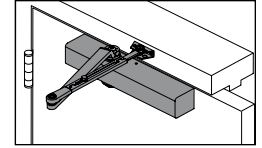

Series	Arm function	Handing	Cylinder	Cover	Price		
					622	689	695
SC81A	♿	RWPA	N/A	CYL	SLIMCOV	\$298.00	
SC81A	♿	HWPA	N/A	CYL	SLIMCOV	\$329.00	
SC81A	♿	HDPA	N/A	CYL	SLIMCOV	\$329.00	
SC81A	♿	DS	N/A	CYL	SLIMCOV	\$357.00	
SC81A	♿	DSHO	N/A	CYL	SLIMCOV	\$389.00	
SC81A	♿	SS	N/A	CYL	SLIMCOV	\$452.00	
SC81A	♿	SSHO	N/A	CYL	SLIMCOV	\$477.00	

SC81A is fully adjustable 1–6.

#### DEFAULT AND COMMON CONFIGURATIONS

Pricing includes default options shown below unless otherwise specified. Specification rules, additional options, and pricing adders are shown in the tables below.

#### Cylinder

Cast Aluminum Cylinder Assembly (CYL)

#### Cover

Slim Cover (SLIMCOV)

#### Screw package

Through Bolt Self Reaming and Tapping Wood and Machine Screws (TBWMSRT)

#### SPECIFICATION RULES, ADDITIONAL OPTIONS, AND PRICING ADDERS

Order of attributes when placing an order for a non-standard configuration. See parts section for individual parts pricing. Attributes shown in CAPS are required. Other attributes are required only if you are deviating from the product's default.

MODEL . ARM TYPE . FINISH . Cover

Cover	Specify (Suffix)	Price adjustment
Slim Cover (SLIMCOV) - Default	-	-
Full Cover (FULLCOV)	FC	\$12.00

SC80A SERIES PARTS AND ACCESSORIES	Specify		Price
	Part number	Finish	
Standard cylinder	FAL.SC81A-307I	.[Finish]	\$191.00
Slim cover	FAL.SC80A-72	.[Finish]	\$17.00
Full cover	SC81A-72FC	.[Finish]	\$26.00
Regular arm with PA bracket	SC81A-3077/PA	.[Finish]	\$92.00
Hold open arm with PA bracket	SC81A-3049/PA	.[Finish]	\$126.00
Heavy duty parallel arm	SC81A-3077HD	.[Finish]	\$126.00
Dead stop parallel arm	SC81A-3077DS	.[Finish]	\$149.00
Hold-open dead stop parallel arm	SC81A-3049DS	.[Finish]	\$183.00
Spring-n-stop arm	SC81A-3077SS	.[Finish]	\$245.00
Hold-open Spring-n-stop arm	SC81A-3049SS	.[Finish]	\$274.00
Mounting plate - Top jamb	SC81A-18	.[Finish]	\$45.00
Mounting plate - Top jamb for full cover	SC81A-18FC	.[Finish]	\$45.00
Mounting plate - PA	SC81A-18PA	.[Finish]	\$45.00
Mounting plate - PA for full cover	SC81A-18PAFC	.[Finish]	\$45.00
Cush shoe support	SC81A-30	.[Finish]	\$31.00
Blade stop spacer	SC81A-61	.[Finish]	\$35.00
Offset auxiliary shoe	SC81A-62A	.[Finish]	\$40.00

Note: Matte Black (622) and Dark Bronze (695) closers share the same screw finish.

689	695
ALUM	DKBRZ

### SC90A SERIES SURFACE DOOR CLOSERS

This light-duty closer is designed for interior residential and light commercial applications.

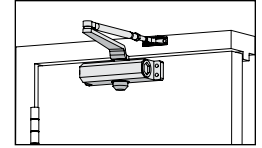

(SC91A shown)

Series	Arm function	Size	Handing	Cylinder	Cover	Price	
						689	695
SC91A	♿	RWPA	1	-	CYL	LESSCOV	\$173.00
SC91A	♿	HWPA	1	-	CYL	LESSCOV	\$206.00
SC93A	♿	RWPA	3	-	CYL	LESSCOV	\$173.00
SC94A	♿	RWPA	4	-	CYL	LESSCOV	\$173.00

Note: Brass finish (696) and Matte Black (622) will not be available with SC91A/SC93A/SC94A.

#### DEFAULT AND COMMON CONFIGURATIONS

Pricing includes default options shown below unless otherwise specified. Specification rules, additional options, and pricing adders are shown in the tables below.

#### Cylinder

Cast Aluminum Cylinder Assembly with Adjustable Backcheck (CYL)

#### Cover

Less Cover (LESSCOV)

#### Screw package

Through Bolt Self Reaming and Tapping Wood and Machine Screws (TBWMSRT)

#### SPECIFICATION RULES, ADDITIONAL OPTIONS, AND PRICING ADDERS

Order of attributes when placing an order for a non-standard configuration. See parts section for individual parts pricing. Attributes shown in CAPS are required. Other attributes are required only if you are deviating from the product's default.

MODEL . ARM TYPE . FINISH . Cover

COVER	Specify (Suffix)	Price adjustment
Less Cover (LESSCOV) - Default	-	-
Standard Cover (SC93A and SC94A only)	STD	\$25.00

SC90A SERIES PARTS AND ACCESSORIES	Specify		Price
	Part number	Finish	
Mounting plate - Top jamb	FAL.SC90A-18	.[Finish]	\$45.00
Mounting plate - Push side	FAL.SC90A-18PA	.[Finish]	\$45.00

600	604	605	605	609	612	613	613	619	619	625	625	626	626	627	628	630	631	
USP	US2C	B3	US3	A5	US10	B10B	US10B	B15	US15	B26	US26	B26D	US26D	US27	US28	US32D	FBLK	
632	633	640	640	645	646	646	651	652	652	666	669	670	671	673	689	702	703	710
US3	US4	F10B	US10B	F14	F15	F-619E	US26	F26D	US26D	A3	A14	A15	ABLK	A92	SP28	A26D	A10B	313AN

ARCHITECTURAL HARDWARE ■ IVES

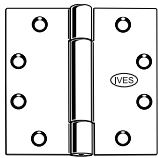

3CB1

Architectural hinges

Model number	Description	Finish	Price
3CB1 4.5x4.5	3 Knuckle plain bearing	652	\$20.50
3CB1 4.5x4.5	3 Knuckle concealed bearing	630	\$91.10
3CB1 4.5x4.5 NRP	3 Knuckle concealed bearing NRP	652	\$28.00
3CB1 4.5x4.5 NRP	3 Knuckle concealed bearing NRP	630	\$98.60
3CB1 HW 4.5x4.5	3 Knuckle concealed bearing heavy wt.	652	\$67.30
3CB1 HW 4.5x4.5 NRP	3 Knuckle concealed bearing heavy wt. NRP	652	\$74.80
3CB1 HW 4.5x4.5 NRP	3 Knuckle concealed bearing heavy wt. NRP	630	\$147.10
3CB1 HW 5x4.5	3 Knuckle concealed bearing heavy wt.	652	\$82.60
3SP1 4.5x4.5	3 Knuckle spring	652	\$36.60
5PB1 4.5x4.5	5 Knuckle plain bearing	652	\$13.70
5PB1 4.5x4.5 NRP	5 Knuckle plain bearing NRP	652	\$21.20
5BB1 4.5x4	5 Knuckle ball bearing	652	\$23.70
5BB1 4.5x4 NRP	5 Knuckle ball bearing NRP	652	\$37.70
5BB1 4.5x4.5	5 Knuckle ball bearing	652	\$17.60
5BB1 4.5x4.5	5 Knuckle ball bearing	630	\$64.60
5BB1 4.5x4.5	5 Knuckle ball bearing	600	\$17.10
5BB1 4.5x4.5	5 Knuckle ball bearing	613	\$96.30
5BB1 4.5x4.5	5 Knuckle ball bearing	619	\$87.60
5BB1 4.5x4.5	5 Knuckle ball bearing	632	\$27.50
5BB1 4.5x4.5	5 Knuckle ball bearing	633	\$21.60
5BB1 4.5x4.5	5 Knuckle ball bearing	639	\$25.90
5BB1 4.5x4.5	5 Knuckle ball bearing	640	\$34.40
5BB1 4.5x4.5	5 Knuckle ball bearing	646	\$32.80
5BB1 4.5x4.5	5 Knuckle ball bearing	651	\$27.50
5BB1 4.5x4.5 NRP	5 Knuckle ball bearing NRP	652	\$25.10
5BB1 4.5x4.5 NRP	5 Knuckle ball bearing NRP	630	\$72.10
5BB1 4.5x4.5 NRP	5 Knuckle ball bearing NRP	600	\$24.60
5BB1 4.5x4.5 NRP	5 Knuckle ball bearing NRP	613	\$110.30
5BB1 4.5x4.5 NRP	5 Knuckle ball bearing NRP	619	\$101.60
5BB1 4.5x4.5 NRP	5 Knuckle ball bearing NRP	640	\$41.90
5BB1 4.5x4.5 NRP	5 Knuckle ball bearing NRP	646	\$40.30
5BB1 5x4.5	5 Knuckle ball bearing	652	\$37.40
5BB1 5x4.5 NRP	5 Knuckle ball bearing NRP	652	\$51.40
5BB1 5x4.5 NRP	5 Knuckle ball bearing NRP	630	\$96.20
5BB1 HW 4.5x4.5	5 Knuckle ball bearing heavy wt.	652	\$51.10
5BB1 HW 4.5x4.5	5 Knuckle ball bearing heavy wt.	630	\$105.90
5BB1 HW 4.5x4.5 NRP	5 Knuckle ball bearing heavy wt. NRP	652	\$58.60

600	604	605	605	609	612	613	613	619	619	625	625	626	626	627	628	630	631	
USP	US2C	B3	US3	A5	US10	B10B	US10B	B15	US15	B26	US26	B26D	US26D	US27	US28	US32D	FBLK	
632	633	640	640	645	646	646	651	652	652	666	669	670	671	673	689	702	703	710
US3	US4	F10B	US10B	F14	F15	F-619E	US26	F26D	US26D	A3	A14	A15	ABLK	A92	SP28	A26D	A10B	313AN

**Architectural hinges**

Model number	Description	Finish	Price
5BB1 HW 4.5x4.5 NRP	5 Knuckle ball bearing heavy wt. NRP	630	\$113.40
5BB1 HW 4.5x4.5 NRP	5 Knuckle ball bearing heavy wt. NRP	613	\$162.40
5BB1 HW 4.5x4.5 NRP	5 Knuckle ball bearing heavy wt. NRP	619	\$148.50
5BB1 HW 5x4.5	5 Knuckle ball bearing heavy wt.	652	\$58.90
5BB1 HW 5x4.5	5 Knuckle ball bearing heavy wt.	630	\$123.80
5BB1 HW 5x4.5 NRP	5 Knuckle ball bearing heavy wt. NRP	652	\$72.90
5BB1 HW 5x4.5 NRP	5 Knuckle ball bearing heavy wt. NRP	630	\$137.80
5BB1 SC 4.5	5 Knuckle ball bearing swing clear	652	\$100.50
5BB1 HW BSC 4.5	5 Knuckle ball bearing heavy wt. beveled swing clear heavy wt.	652	\$121.80
5BB1 HW BSC 5	5 Knuckle ball bearing heavy wt. beveled swing clear heavy wt.	652	\$121.80

**Continuous hinges**

Model number	Description	Finish	Price
112HD 83"	Continuous geared, heavy duty 83" length	628	\$279.20
224HD 83"	Continuous geared with edge protector, heavy duty, 83"	628	\$297.90
700 83"	Continuous pin and barrel, 83"	630	\$804.60
700 95"	Continuous pin and barrel, 95"	630	\$931.40
705 83"	Continuous pin and barrel, full wrap, 83"	630	\$1,049.80

**Pivots**

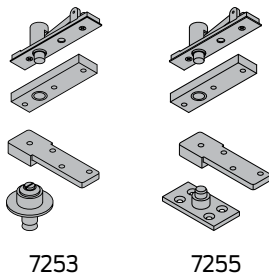

Model number	Description	Handing	Finish	Price
7215 SET RH US26D	3/4" Offset pivot set, 500 lb	RH	626	\$666.20
7215 SET LH US26D	3/4" Offset pivot set, 500 lb	LH	626	\$666.20
7226 SET US26D	3/4" Offset pivot set, 600 lb	-	626	\$590.70
7230F SET US32D	3/4" Offset pivot set, 1000 lb, Fire Rated	-	630	\$1,103.00
7253 SET US26D	Center hung pivot set, 300 lb	-	626	\$489.00
7255 SET US26D	Center hung pivot set, 500 lb	-	626	\$539.20

Note: Set includes top-and-bottom pivots.



600	604	605	605	609	612	613	613	619	619	625	625	626	626	627	628	630	631	
USP	US2C	B3	US3	A5	US10	B10B	US10B	B15	US15	B26	US26	B26D	US26D	US27	US28	US32D	FBLK	
632	633	640	640	645	646	646	651	652	652	666	669	670	671	673	689	702	703	710
US3	US4	F10B	US10B	F14	F15	F-619E	US26	F26D	US26D	A3	A14	A15	ABLK	A92	SP28	A26D	A10B	313AN

**Intermediate pivots**

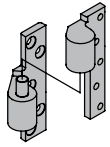

7215-7226-7227 INT

Model number	Description	Handing	Finish	Price
7215-7226-7227 INT RH	3/4" Offset intermediate pivot for 7215, 7226 and 7227	RH	626	\$340.40
7215-7226-7227 INT LH	3/4" Offset intermediate pivot for 7215, 7226 and 7227	LH	626	\$340.40
7230F-7237F INT RH	3/4" Offset intermediate pivot for 7230F and 7237F, Fire Rated	RH	630	\$666.20
7230F-7237F INT LH	3/4" Offset intermediate pivot for 7230F and 7237F, Fire Rated	LH	630	\$666.20

**Pocket pivot**

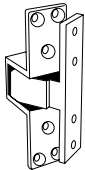

91105F

Model number	Description	Finish	Price
91105F	Pocket pivot, Fire Rated	630	\$713.10

Note: Pocket pivots are sold individually.

**Architectural pulls/push bars**

Model number	Size	Center to Center	Finish	Price
8103HD-0	Straight 10" pull, heavy duty, 1" diameter	-	630	\$104.50
8103EZHD-0	Straight 10" pull, ADA compliant, heavy duty, 1" diameter	-	630-316	\$144.50
8190HD-0	90° Offset 10" pull, heavy duty, 1-3/4"	10"	630	\$141.10
8190HD-0	90° Offset 10" pull, heavy duty, 1-3/4"	10"	613	\$285.10
8190HD-0	90° Offset 10" pull, heavy duty, 1-3/4"	10"	619	\$225.00
8190HD-2	90° Offset 12" pull, heavy duty, 1-3/4"	12"	630	\$152.10
8190HD-0	90° Offset 10" pull, heavy duty, 1-3/4" (dec. thru-bolt)	10"	630	\$141.10
8190HD-2	90° Offset 12" pull, heavy duty, 1-3/4" (dec. thru-bolt)	12"	630	\$152.10
9190HD-33-0	33" Pushbar/90° Offset 10" pull, heavy duty, 1-3/4"	33", 10"	630	\$477.90

600	604	605	605	609	612	613	613	619	619	625	625	626	626	627	628	630	631	
USP	US2C	B3	US3	A5	US10	B10B	US10B	B15	US15	B26	US26	B26D	US26D	US27	US28	US32D	FBLK	
632	633	640	640	645	646	646	651	652	652	666	669	670	671	673	689	702	703	710
US3	US4	F10B	US10B	F14	F15	F-619E	US26	F26D	US26D	A3	A14	A15	ABLK	A92	SP28	A26D	A10B	313AN

**Push plates**

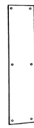

8200

Model number	Size	Finish	Price
8200-3.5x15-US32D	Push plate 3.5" x 15"	630	\$29.00
8200-3.5x15-US10B	Push plate 3.5" x 15"	613	\$108.70
8200-3.5x15-US15	Push plate 3.5" x 15"	619	\$62.10
8200-3.5x15-US28	Push plate 3.5" x 15"	628	\$23.60
8200-4x16-US32D	Push plate 4" x 16"	630	\$33.90
8200-4x16-US10B	Push plate 4" x 16"	613	\$123.10
8200-4x16-US15	Push plate 4" x 16"	619	\$70.10
8200-4x16-US26D	Push plate 4" x 16"	626	\$67.70
8200-4x16-US28	Push plate 4" x 16"	628	\$22.10
8200-6x16-US32D	Push plate 6" x 16"	630	\$46.10
8200-8x16-US32D	Push plate 8" x 16"	630	\$64.50

**Pull plates**



8302

Model number	Size	Center to Center	Finish	Price
8302-6	8102 6" Pull and plate 4" x 16", 1-3/4"	6"	630	\$104.90
8302-8	8102 8" Pull and plate 3.5" x 15", 1-3/4"	8"	630	\$109.60
8302-8	8102 8" Pull and plate 4" x 16", 1-3/4"	8"	630	\$113.90
8302-0	8102 10" Pull and plate 3.5" x 15", 1-3/4"	10"	630	\$122.60
8302-0	8102 10" Pull and plate 4" x 16", 1-3/4"	10"	630	\$126.70
8303-8	8103 8" Pull and plate 4" x 16", 1-3/4"	8"	630	\$170.00
8303-0	8103 10" Pull and plate 4" x 16", 1-3/4"	10"	630	\$185.80

**Protection plates**

Model number	Size	Finish	Price
8400 8x34 US32D	8" x 34" B-CS	630	\$78.90
8400 10X34 US32D	10" x 34" B-CS	630	\$98.70
8400 10X35 US32D	10" x 35" B-CS	630	\$104.40

**Vandal resistant trim**

Model number	Description	Finish	Price
VR910-NL STD US32D	Vandal resistant trim 98/99 Rim or Vertical Rod, horizontal keyway	630	\$435.60
VR910-DT STD US32D	Vandal resistant trim 98/99 Rim or Vertical Rod, blank trim	630	\$435.60

600	604	605	605	609	612	613	613	619	619	625	625	626	626	627	628	630	631	
USP	US2C	B3	US3	A5	US10	B10B	US10B	B15	US15	B26	US26	B26D	US26D	US27	US28	US32D	FBLK	
632	633	640	640	645	646	646	651	652	652	666	669	670	671	673	689	702	703	710
US3	US4	F10B	US10B	F14	F15	F-619E	US26	F26D	US26D	A3	A14	A15	ABLK	A92	SP28	A26D	A10B	313AN

**Pulls**

Model number	Size	Finish	Price
230B26D	Sliding door edge pull	626	\$25.00
990B-613	Sliding door pull	613	\$21.00
990B-619	Sliding door pull	619	\$21.00
991B-613	Sliding door pull - locking	613	\$29.30
991B-619	Sliding door pull - locking	619	\$29.30
991B-643E/716	Sliding door pull - locking	643E/716	\$29.30
221B26D	Flush pull, large circle	626	\$6.90
221B10B	Flush pull, large circle	613	\$6.90
221B15	Flush pull, large circle	619	\$6.70
222B26D	Flush pull, rectangular	626	\$38.60
223B26D	Flush pull, oval	626	\$11.50
227B26D	Flush pull, deep well	626	\$17.80

**Flush bolts**

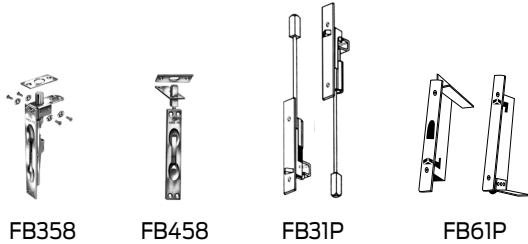

Model number	Description	Door Type	Finish	Price
FB358 US26D	Manual flush bolt, single door	Wood	626	\$58.20
FB358 US10B	Manual flush bolt, single door	Wood	613	\$58.20
FB358 US15	Manual flush bolt, single door	Wood	619	\$62.80
FB457-12 US26D	Manual flush bolt, single door	Metal	626	\$44.10
FB458-12 US26D	Manual flush bolt, single door	Metal	626	\$34.70
FB458-12 US3	Manual flush bolt, single door	Metal	605	\$36.60
FB458-12 US15	Manual flush bolt, single door	Metal	619	\$36.60
FB31P-12-MD US32D	Automatic flush bolt, pair	Metal	630	\$299.70
FB41P-WD US32D	Automatic flush bolt, pair	Wood	630	\$319.70
FB51P-12-MD US32D	Constant latching flush bolt, pair	Metal	630	\$305.60
FB61P-WD US32D	Constant latching flush bolt, pair	Wood	630	\$341.40
262B26D	Manual flush bolt, brass	-	626	\$52.20
262B3	Manual flush bolt, brass	-	605	\$48.80
262B10B	Manual flush bolt, brass	-	613	\$52.20
262B15	Manual flush bolt, brass	-	619	\$56.20
FB256/7/8/457/8/0458-18"	Manual flush bolt rod - 18" (use p/n 09-161 when ordering)	-	-	\$9.70
FB256/7/8/457/8/0458-24"	Manual flush bolt rod - 24" (use p/n 09-162 when ordering)	-	-	\$9.70
FB256/7/8/457/8/0458-36"	Manual flush bolt rod - 36" (use p/n 09-172 when ordering)	-	-	\$9.70

600	604	605	605	609	612	613	613	619	619	625	625	626	626	627	628	630	631	
USP	US2C	B3	US3	A5	US10	B10B	US10B	B15	US15	B26	US26	B26D	US26D	US27	US28	US32D	FBLK	
632	633	640	640	645	646	646	651	652	652	666	669	670	671	673	689	702	703	710
US3	US4	F10B	US10B	F14	F15	F-619E	US26	F26D	US26D	A3	A14	A15	ABLK	A92	SP28	A26D	A10B	313AN

**Dust-proof strikes**

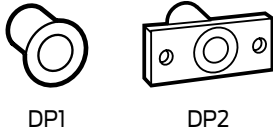

Model number	Description	Finish	Price
DP1 US26D	Dust-proof strike, threshold only	626	\$42.40
DP2 US26D	Dust-proof strike, floor and/or threshold	626	\$53.30
DP2 US10B	Dust-proof strike, floor and/or threshold	613	\$53.30

**Coordinators and mounting brackets**

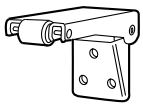

Model number	Description	Finish	Price
COR52 US28w/FL20	Coordinator bar, 52" overall length with 20" filler bar	628	\$268.10
COR52 US28	Coordinator bar, 52" overall length	628	\$243.80
FL 20 US28	Filler bar, 20" overall length	628	\$24.30
MB1 SP28	Mounting bracket, stops over 2-1/2"	689	\$46.20
MB1 USP	Mounting bracket, stops over 2-1/2"	600	\$32.40
MB2 SP28	Mounting bracket, stops up to 2-1/2"	689	\$52.20
MB2 USP	Mounting bracket, stops up to 2-1/2"	600	\$38.00
CB1 USP	Carry bar	600	\$57.30

**Surface bolts**

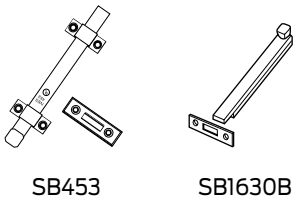

Model number	Description	Finish	Price
40B26D 4	4" Decorative surface bolt, light duty	626	\$27.20
054B26D	Dutch door bolt	626	\$71.10
SB360 US2C 12	12" Surface bolt, heavy duty, universal strike	604	\$172.30
SB453US2C-8-TB	8" Surface bolt, top and bottom strikes	604	\$62.80
SBI630-B US2G	8" Surface bolt, bottom strike	603	\$69.70
SBI630-T US2G	8" Surface bolt, top strike	603	\$77.70
SBI630-TB US2G	8" Surface bolt, top and bottom strikes	603	\$91.90

600	604	605	605	609	612	613	613	619	619	625	625	626	626	627	628	630	631	
USP	US2C	B3	US3	A5	US10	B10B	US10B	B15	US15	B26	US26	B26D	US26D	US27	US28	US32D	FBLK	
632	633	640	640	645	646	646	651	652	652	666	669	670	671	673	689	702	703	710
US3	US4	F10B	US10B	F14	F15	F-619E	US26	F26D	US26D	A3	A14	A15	ABLK	A92	SP28	A26D	A10B	313AN

**Roller latches, invisible latches, and ball-type or cabinet catch**

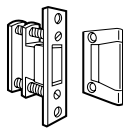

RL30

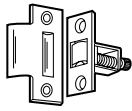

RL36

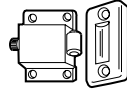

RL38

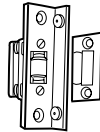

RL1152

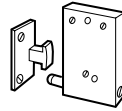

CL11

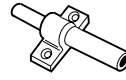

CL14

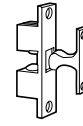

CL21A

Model number	Description	Finish	Price
RL30 US26D	Roller latch, high traffic	626	\$105.30
RL32 US26D	Roller latch, light-duty, mortise	626	\$142.20
RL36 US32D	Roller latch, light-duty, mortise	630	\$80.30
RL38 US32D	Roller latch, light-duty, surface mounted	630	\$75.70
RL1152 US26D	Roller latch with angle stop	626	\$209.80
CL11 US26D	Invisible latch, 7/16" x 1-1/4" x 1-7/8"	626	\$54.10
CL12 US26D	Invisible latch, 9/16" x 1-1/4" x 2-1/4"	626	\$66.00
CL14 US26D	Invisible latch auxiliary pusher	626	\$61.80
CL21A US26D	Ball catch, four-way, full size doors	626	\$53.30
CL22 US26D	Ball catch, three-way, smaller doors	626	\$38.70
325A92	Magnetic catch, light duty, single magnet	673	\$4.60
326A92	Magnetic catch, heavy duty, two magnet	673	\$13.30
327A92	Magnetic catch, heavy duty, four magnet	673	\$22.70
335B10B	Roller catch, adjustable	613	\$27.20
336B15	Roller catch adjustable	619	\$29.30
347B26D	Ball catch, square corners	626	\$22.40
347B10B	Ball catch, square corners	613	\$22.40
347B15	Ball catch, square corners	619	\$21.30
347B26	Ball catch, square corners	625	\$22.40
349B26D	Ball catch, round corners	626	\$23.50
349B3	Ball catch, round corners	605	\$21.40
349B15	Ball catch, round corners	625	\$24.40
2A92	Cabinet catch, elbow	673	\$6.20
2A3	Cabinet catch, elbow	666	\$6.20
42B10B	Pocket door bolt	613	\$26.90
42B15	Pocket door bolt	619	\$25.80
42B26	Pocket door bolt	625	\$26.90

**Door silencers and crash stops**



SR64

Model number	Description	Door type	Finish	Price
SR64 GRY	Door silencers for metal frames, bag of 100	Metal	Gray	\$51.10
SR65 GRY	Door silencer for wood frames, bag of 100	Wood	Gray	\$51.10
CS115-20	Crash stop	-	626	\$75.90

600	604	605	605	609	612	613	613	619	619	625	625	626	626	627	628	630	631	
USP	US2C	B3	US3	A5	US10	B10B	US10B	B15	US15	B26	US26	B26D	US26D	US27	US28	US32D	FBLK	
632	633	640	640	645	646	646	651	652	652	666	669	670	671	673	689	702	703	710
US3	US4	F10B	US10B	F14	F15	F-619E	US26	F26D	US26D	A3	A14	A15	ABLK	A92	SP28	A26D	A10B	313AN

**Floor stops, dome stops, and kick downs**



Model number	Description	Finish	Price
FS13 US26D	Dome stop	626	\$12.60
FS18S	Security floor stop, 1-1/2" bumper	-	\$17.90
FS18L	Security floor stop, 3 1/2" bumper	-	\$25.60
FS40 US26D	Floor stop w/ automatic holder, 1/2" door to floor clearance	626	\$96.30
FS434 US2C	Floor stop, angle	604	\$14.10
FS436 US26D	Dome stop	626	\$9.40
FS436 US3	Dome stop	605	\$11.20
FS436 US10B	Dome stop	613	\$11.80
FS436 US15	Dome stop	619	\$11.80
FS436 US26	Dome stop	625	\$10.90
FS436 US28	Dome stop	628	\$7.80
FS438 US26D	Dome stop for use with thresholds	626	\$10.50
FS438 US10B	Dome stop for use with thresholds	613	\$14.30
FS438 US15	Dome stop for use with thresholds	619	\$18.10
FS438 US26	Dome stop for use with thresholds	625	\$14.20
FS438 US28	Dome stop for use with thresholds	628	\$9.70
R435-1/2	1/2" Riser for FS436 dome stop	627	\$10.60
FS441 US26D	Floor stop	626	\$34.90
FS441 US10B	Floor stop	613	\$38.40
FS441 US15	Floor stop	619	\$53.50
FS444 US26D	Floor stop, heavy-duty, masonry	626	\$41.20
FS444 US10B	Floor stop, heavy-duty, masonry	613	\$50.20
FS444 US15	Floor stop, heavy-duty, masonry	619	\$58.80
FS446 US26D	Floor stop w/ manual holder, heavy-duty, masonry	626	\$60.00
FS446 US10B	Floor stop w/ manual holder, heavy-duty, masonry	613	\$75.10
FS446 US15	Floor stop w/ manual holder, heavy-duty, masonry	619	\$84.20
FS448 US26D	Floor stop, heavy-duty, drywall/wood	626	\$48.00
FS448 US10B	Floor stop, heavy-duty, drywall/wood	613	\$46.40
FS450 US26D	Floor stop w/ manual holder, heavy-duty, drywall/wood	626	\$65.30
FS452-4 US26D	Kick down holder, 4"	626	\$44.50
FS452-4 US15	Kick down holder, 4"	619	\$68.30
FS452-5 US26D	Kick down holder, 5"	626	\$55.20
FS452-5 US10B	Kick down holder, 5"	613	\$69.00
FS452-5 US15	Kick down holder, 5"	619	\$77.80
FS455-4 US26D	Kick down holder, 4"	626	\$60.30
FS455-4 US3	Kick down holder, 4"	605	\$54.10
FS455-4 US10B	Kick down holder, 4"	613	\$60.30
FS455-4 US27	Kick down holder, 4"	627	\$12.70
FS455-4 US3AL	Kick down holder, 4"	666	\$13.70

600	604	605	605	609	612	613	613	619	619	625	625	626	626	627	628	630	631	
USP	US2C	B3	US3	A5	US10	B10B	US10B	B15	US15	B26	US26	B26D	US26D	US27	US28	US32D	FBLK	
632	633	640	640	645	646	646	651	652	652	666	669	670	671	673	689	702	703	710
US3	US4	F10B	US10B	F14	F15	F-619E	US26	F26D	US26D	A3	A14	A15	ABLK	A92	SP28	A26D	A10B	313AN

**Floor stops, dome stops, and kick downs**

Model number	Description	Finish	Price
FS544 SP28	Kick down holder, 4"	689	\$18.40
FS544 SP4	Kick down holder, 4"	706	\$20.00
FS555 SP28	Kick down holder, 5"	689	\$20.00
FS544/555	Kick down holder - rubber w/ screw (use p/n FSPART.1074 When ordering)	-	\$4.60
FS1153 US28	Plunger-type door holder — 1-5/8" throw	628	\$75.10
FS1154 US10	Plunger-type door holder — 1-1/4" throw	612	\$146.00

**Residential door stops**

Model number	Description	Finish	Price
060F26D	Residential, flexible door stop, 3", steel	652	\$2.00
060F10B	Residential, flexible door stop, 3", steel	640	\$2.00
060F14	Residential, flexible door stop, 3", steel	645	\$2.00
060F15	Residential, flexible door stop, 3", steel	646	\$2.00
63F-619E	Residential, flexible door stop, 3", steel	646	\$1.50
63F643E/716	Residential, flexible door stop, 3", steel	F643E/716E	\$1.50
60A92	Residential, solid door stop, 3-3/4", aluminum	673	\$5.60
61A92	Residential, solid door stop, 3-1/8", aluminum	673	\$5.60
61A10B	Residential, solid door stop, 3-1/8", aluminum	703	\$5.60
61A14	Residential, solid door stop, 3-1/8", aluminum	669	\$5.60
61A15	Residential, solid door stop, 3-1/8", aluminum	670	\$5.60
61AW	Residential, solid door stop, 3-1/8", aluminum	White	\$6.00
61B15	Residential, solid door stop, 3-1/8", brass	619	\$25.80
60-5/062/70/430	Replacement rubber tips for 60, 61, 70 stops (100/pkg)	-	\$1.50
69F14	Hinge pin door stop (70–100° adjustment), steel	645	\$6.90
69F15	Hinge pin door stop (70–100° adjustment), steel	646	\$6.90
70A92	Hinge pin door stop (85–125° adjustment), aluminum	673	\$3.60
70A643E/716	Hinge pin door stop (85–125° adjustment), aluminum	A-643E/716	\$4.20
70A10B	Hinge pin door stop (85–125° adjustment), aluminum	703	\$4.20
70A15	Hinge pin door stop (85–125° adjustment), aluminum	670	\$4.20
70B10B	Hinge pin door stop (85–125° adjustment), brass	613	\$22.90
70B15	Hinge pin door stop (85–125° adjustment), brass	619	\$22.90

**Wall stops and holders**

Model number	Description	Screw Pkg.	Finish	Price
WS445 US26D	Wall stop with manual holder, heavy-duty	Masonry	626	\$106.40
WS447 US26D	Wall stop, heavy-duty	Drywall & Wood	626	\$61.00
WS40 US26D	Automatic wall stop and holder	Universal	626	\$162.20
WS45 US26D	Automatic wall holder for drywall mounting	Universal	626	\$225.70

600	604	605	605	609	612	613	613	619	619	625	625	626	626	627	628	630	631	
USP	US2C	B3	US3	A5	US10	B10B	US10B	B15	US15	B26	US26	B26D	US26D	US27	US28	US32D	FBLK	
632	633	640	640	645	646	646	651	652	652	666	669	670	671	673	689	702	703	710
US3	US4	F10B	US10B	F14	F15	F-619E	US26	F26D	US26D	A3	A14	A15	ABLK	A92	SP28	A26D	A10B	313AN

**Wall stops/bumpers**



WS401/402CCV



WS401/402CVX



WS404CVX



WS406/407CCV



WS406/407CVX

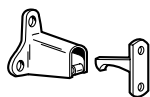

WS40

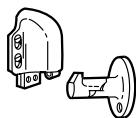

WS45

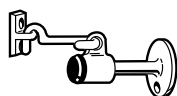

WS445

Model number	Description	Screw Pkg.	Finish	Price
WS401/402CCV US26D	Wall bumper, cast, concave	Drywall & Wood	626	\$30.30
WS401/402CVX US26D	Wall bumper, cast, convex	Drywall & Wood	626	\$30.30
WS404 US26D	Wall bumper, compact, convex	Drywall & Wood	626	\$10.70
WS406/407CCV US32D	Wall bumper, concave	Drywall & Wood	630	\$5.40
WS406/407CCV US3	Wall bumper, concave	Drywall & Wood	605	\$6.20
WS406/407CCV US10	Wall bumper, concave	Drywall & Wood	612	\$7.00
WS406/407CCV US10B	Wall bumper, concave	Drywall & Wood	613	\$7.00
WS406/407CVX US32D	Wall bumper, convex	Drywall & Wood	630	\$4.90
WS406/407CVX US10B	Wall bumper, convex	Drywall & Wood	613	\$7.00
WS406/407CVX US15	Wall bumper, convex	Drywall & Wood	619	\$7.00
411R-W	Wall bumper, adhesive back	-	-	\$4.50
WS33 US26D	Wall stop	Drywall & Wood	626	\$81.70
FS495 US26D	Wall stop with automatic holder	-	626	\$131.10

**Lock guards**



LG1

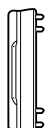

LG10

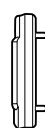

LG13

Model number	Description	Finish	Price
LG1 US2G	Lock guard with security pin	603	\$33.70
LG1 US32D	Lock guard with security pin	630	\$77.50
LG10 US32D	Lock guard	630	\$72.20
LG12 US32D	Lock guard	630	\$67.20
LG13 US32D	Lock guard	630	\$64.50
LG14 US32D	Lock guard	630	\$99.90

**Viewers**

Model number	Description	Finish	Price
U696B26D	Door viewer, 150°, UL listed 90 min	626	\$24.70
698B26D	Door viewer, 190°, for doors 1-3/8" to 2-1/8"	626	\$29.00
U698B26D	Door viewer, 190°, for doors 1-3/8" to 2-1/8", UL listed 90 min	626	\$34.70
U698B3	Door viewer, 190°, for doors 1-3/8" to 2-1/8", UL listed 90 min	605	\$37.50
700B26D	One way viewer, narrow angle	626	\$12.70
U700B26D	Door viewer, 120°, for doors 1-3/8" to 2-1/16", UL listed 90 min	626	\$17.00



600	604	605	605	609	612	613	613	619	619	625	625	626	626	627	628	630	631	
USP	US2C	B3	US3	A5	US10	B10B	US10B	B15	US15	B26	US26	B26D	US26D	US27	US28	US32D	FBLK	
632	633	640	640	645	646	646	651	652	652	666	669	670	671	673	689	702	703	710
US3	US4	F10B	US10B	F14	F15	F-619E	US26	F26D	US26D	A3	A14	A15	ABLK	A92	SP28	A26D	A10B	313AN

**Hooks**

Model number	Description	Finish	Price
405A92	Coat and hat hook, aluminum	673	\$4.20
571A92	Coat and hat hook, aluminum	673	\$2.00
571A3	Coat and hat hook, aluminum	666	\$2.00
571B10B	Coat and hat hook, brass	613	\$16.10
571B15	Coat and hat hook, brass	619	\$15.70
572B26D	Coat and hat hook, brass	626	\$20.60
580A92	Ceiling hook, aluminum	673	\$4.30
581A92	Wardrobe hook, aluminum	673	\$2.60
582A92	Double wardrobe hook, aluminum	673	\$2.90
582B26D	Double wardrobe hook, brass	626	\$13.40

**Hand rail brackets**

Model number	Description	Finish	Price
059A92	Hand rail bracket, aluminum	673	\$5.80
059ABLK	Hand rail bracket, aluminum	671	\$7.40
059AW	Hand rail bracket, aluminum	White	\$7.40
59A3	Hand rail bracket, aluminum	666	\$5.90
59A15	Hand rail bracket, aluminum	670	\$7.30
59A643E/716	Hand rail bracket, aluminum	643E/716	\$7.30
59B15	Hand rail bracket, brass	619	\$42.70
HB159 US27	Hand rail bracket, aluminum	627	\$27.90

**Window hardware**

Model number	Description	Finish	Price
07B3	Window lock, brass	605	\$25.10
07B15	Window lock, brass	619	\$31.90

<b>619</b>	<b>622</b>	<b>630</b>	<b>716</b>
US15	US19	US32D	643e

**SCHLAGE RESIDENTIAL BARN DOOR HARDWARE**

<b>J-STRAP</b>					
<b>Description</b>	<b>Finish</b>	<b>Track length</b>	<b>SKU</b>	<b>Special order</b>	<b>Price</b>
SD10-6.6 619 JSTP N N SL, Satin Nickel J-strap	619	6' 6"	043156002634		\$351.00
SD10-6.6 622 JSTP N N SL, Black J-strap	622	6' 6"	043156002641		\$221.00
SD10-6.6 630 JSTP N N SL, Stainless Steel J-strap	630	6' 6"	043156002658		\$443.00
SD10-6.6 716 JSTP N N SL, Aged Bronze J-strap	716	6' 6"	043156002672		\$343.00
SD10-8.0 619 JSTP N N SL, Satin Nickel J-strap	619	8'	043156002832		\$361.00
SD10-8.0 622 JSTP N N SL, Black J-strap	622	8'	043156002849		\$226.00
SD10-8.0 630 JSTP N N SL, Stainless Steel J-strap	630	8'	043156002856		\$453.00
SD10-8.0 716 JSTP N N SL, Aged Bronze J-strap	716	8'	043156002870		\$340.00

<b>TOP MOUNT</b>					
<b>Description</b>	<b>Finish</b>	<b>Track length</b>	<b>SKU</b>	<b>Special order</b>	<b>Price</b>
SD10-6.6 619 TMNT N N SL, Satin Nickel Top mount	619	6' 6"	043156002788		\$351.00
SD10-6.6 622 TMNT N N SL, Black Top mount	622	6' 6"	043156002795		\$221.00
SD10-6.6 630 TMNT N N SL, Stainless Steel Top mount	630	6' 6"	043156002801		\$443.00
SD10-6.6 716 TMNT N N SL, Aged Bronze Top mount	716	6' 6"	043156002825		\$343.00
SD10-8.0 619 TMNT N N SL, Satin Nickel Top mount	619	8'	043156002986		\$361.00
SD10-8.0 622 TMNT N N SL, Black Top mount	622	8'	043156002993		\$226.00
SD10-8.0 630 TMNT N N SL, Stainless Steel Top mount	630	8'	043156003006		\$453.00
SD10-8.0 716 TMNT N N SL, Aged Bronze Top mount	716	8'	043156003020		\$340.00

619	622	630	716
US15	US19	US32D	643e

## SCHLAGE RESIDENTIAL SLIDING DOOR HARDWARE



TRACK ADAPTER				
Description	Finish	SKU	Special Order	Price
SD10 619 ADPTR N N SL, Satin Nickel Track Adapter	619	043156003051		\$18.30
SD10 622 ADPTR N N SL, Black Track Adapter	622	043156003068		\$15.80
SD10 630 ADPTR N N SL, Stainless Steel Track Adapter	630	043156003075		\$19.30
SD10 716 ADPTR N N SL, Aged Bronze Track Adapter	716	043156003099		\$18.30

626	630	652
US26D	US32D	US26D

### OVERHEAD STOPS AND HOLDERS

#### 70 Series

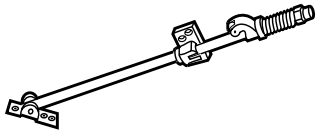

Model	Description	Size	Function	Finish	Price
704H	70 Series Stop and holder	4	Hold-Open	626	\$367.00
704S	70 Series Stop	4	Stop Only	626	\$367.00

#### 81 Series

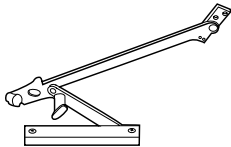

Model	Description	Size	Function	Finish	Price
814H	81 Series Stop and holder	4	Hold-Open	630	\$511.00
814S	81 Series Stop	4	Stop Only	630	\$447.00

#### 90 Series

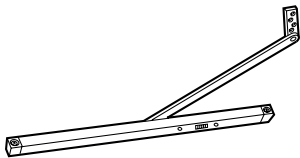

Model	Description	Size	Function	Finish	Price
903H	90 Series Stop and holder	3	Hold-Open	630	\$503.00
904H	90 Series Stop and holder	4	Hold-Open	630	\$503.00
905H	90 Series Stop and holder	5	Hold-Open	630	\$503.00
906H	90 Series Stop and holder	6	Hold-Open	630	\$503.00
903S	90 Series Stop	3	Stop Only	630	\$503.00
904S	90 Series Stop	4	Stop Only	630	\$503.00
905S	90 Series Stop	5	Stop Only	630	\$503.00
906S	90 Series Stop	6	Stop Only	630	\$503.00
AJK90	Angle jamb bracket kit	-	-	652	\$85.50

<b>613</b>	<b>630</b>	<b>652</b>
US10B	US32D	US26D

OVERHEAD STOPS AND HOLDERS

**100 Series**

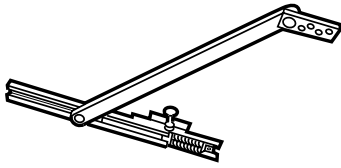

Model	Description	Size	Function	Finish	Price
104H	100 Series Stop and holder	4	Hold-Open	630	\$489.00
105H	100 Series Stop and holder	5	Hold-Open	630	\$489.00
102S	100 Series Stop	2	Stop-Only	630	\$489.00
103S	100 Series Stop	3	Stop-Only	630	\$489.00
104S	100 Series Stop	4	Stop-Only	630	\$489.00
104S	100 Series Stop	4	Stop-Only	613	\$515.00
104S ADJ	100 Series Stop with ADJ	4	Stop-Only	630	\$587.00
105S	100 Series Stop	5	Stop-Only	630	\$489.00
106S	100 Series Stop	6	Stop-Only	630	\$489.00

**410 Series**

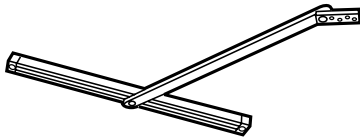

Model	Description	Size	Function	Finish	Price
414H	410 Series Stop and holder	4	Hold-Open	630	\$181.00
413S	410 Series Stop	3	Stop Only	630	\$181.00
414S	410 Series Stop	4	Stop Only	630	\$181.00
414S	410 Series Stop	4	Stop Only	652	\$151.00

<b>613</b>	<b>630</b>	<b>652</b>	<b>689</b>
US10B	US32D	US26D	SP28

OVERHEAD STOPS AND HOLDERS

**450 Series**

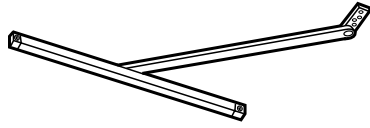

Model	Description	Size	Function	Finish	Price
454H	450 Series Stop and holder	4	Hold-Open	630	\$224.00
454H	450 Series Stop and holder	4	Hold-Open	652	\$172.00
451S	450 Series Stop	1	Stop Only	630	\$224.00
451S	450 Series Stop	1	Stop Only	652	\$172.00
452S	450 Series Stop	2	Stop Only	630	\$224.00
452S	450 Series Stop	2	Stop Only	652	\$172.00
453S	450 Series Stop	3	Stop Only	630	\$224.00
453S	450 Series Stop	3	Stop Only	652	\$172.00
454S	450 Series Stop	4	Stop Only	630	\$224.00
454S	450 Series Stop	4	Stop Only	652	\$172.00
454S	450 Series Stop	4	Stop-Only	613	\$246.00
454S	450 Series Stop	4	Stop-Only	689	\$147.00
455S	450 Series Stop	5	Stop Only	630	\$224.00
455S	450 Series Stop	5	Stop Only	652	\$172.00

## HOW TO ORDER ■ SCHLAGE RESIDENTIAL

Thank you for your order and continuing business. In order to expedite order processing, please include the following information on purchase orders:

- Schlage account number
- Product UPC numbers (if available)
- Quote number (if applicable)
- Specific keying requirements
  - Note: Line quantities of keyed products must be divisible by KA quantities.  
Example: 20 locks ordered KA4 results in 5 groups of 4 locks keyed alike, however, 20 locks ordered KA3 is not divisible and results in order processing delays as Schlage seeks clarification

## Door handing

**How to identify door handing:**

Handing of all doors is determined from the exterior of the room's entrance.

- If the hinge is on the left side of the door, the door is "left hand" (LH)
- If the hinge is on the right side of the door, the door is "right hand" (RH)
- To order a handed product, please specify LH or RH
- To order a handleset, handing is still determined from the exterior of the door
- We will use that information to determine the handing for the inside of the door

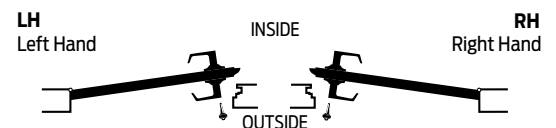
**LEVER HANDING DIAGRAM**

HOW TO ORDER ▪ SCHLAGE COMMERCIAL MECHANICAL

To order Schlage products, descriptive data should be in the same sequence as shown:

Line Item	Qty	Product	Outside		Inside		Hand	Latch	Strike	Dr Thk	Ext	DIM	Additional Details
			DES	FIN	DES	FIN							
1	2	3	4	5	6	7	8	9	10	11	12	13	14

1. **LINE ITEM:** Line item number
2. **QTY:** Quantity
3. **PRODUCT:** Complete lock product or part number
4. **OUTSIDE DES:** Outside design code
5. **OUTSIDE FIN:** Outside finish code
6. **INSIDE DES:** Inside design code. Leave blank if same as outside design code.
7. **INSIDE FIN:** Inside finish code. Leave blank if same as outside finish code.
8. **HAND:** Hand of door. Only one hand allowed per line item.
  - Example: RH=Right Hand, LH=Left Hand, RR=Right Reverse, LR=Left Reverse.

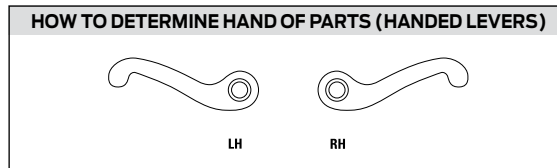
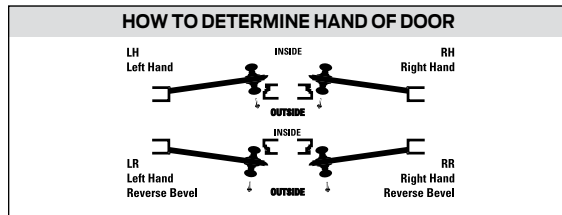

9. **LATCH:** Latch. Leave blank for standard or specify part number if non-standard latch is required. LLL=Less Latch.
10. **STRIKE:** Strike. Leave blank for standard or specify part number if non-standard strike is required. LLL=Less Strike.
11. **DR THK:** Door Thickness. Enter door thickness if non-standard.
  - Example: 138=1-3/8", 214=2-1/4", 212=2-1/2".
12. **EXT:** Extension. Enter one of the following when doors 2" thick or greater are specified:
  - EE = Extended Equally
  - EI = Extended Inside
  - EO = Extended Outside
  - ED = Extended Differently
  - EI or EO assumes the latch will be centered on a 1-3/4" door, to which material has been added.
13. **DIM:** Enter dimension for non-standard strike lip length and mortise cylinder or blocking ring length.
  - 012 = 1/8"    118 = 1-1/8"
  - 018 = 3/16"    114 = 1-1/4"
  - 025 = 1/4"    138 = 1-3/8"
  - 031 = 5/16"    112 = 1-1/2"
  - 037 = 3/8"    158 = 1-5/8"
  - 050 = 1/2"    134 = 1-3/4"
  - 078 = 7/8"    200 = 2"
  - 100 = 1"    400 = 4"
14. **ADDITIONAL DETAILS:** Enter detail for keying information and for special requirements.

SCHLAGE LOCKS  
COMMERCIAL WIRELESS ELECTRONIC  
COMMERCIAL MECHANICAL  
EXIT DEVICES  
DOOR CLOSERS  
ACCESSORIES



HOW TO ORDER ■ LE MORTISE MOBILE ENABLED WIRELESS LOCK



**Standard features**

Certification	ANSI/BHMA Certified A156.25-2013 (Indoor/Outdoor), ANSI/BHMA Certified A156.13-2012, Series 1000, Grade 1 UL 294, ULC S319, UL 10C 3-hour rated
Case size	4-7/16" x 6-1/16" x 1"
Armor front	1-1/4" x 8"
Deadbolt	1" throw stainless steel
Latch bolt	3/4" throw stainless steel with anti-friction tongue
Strike	1-1/4" x 4-7/8", square corner, 1-3/16" lip with box and DPS
Backset	2-3/4"
Cylinder	6-pin solid brass, keyed 6-pin, S123 keyway, keyed different (KD)
Door range	1-3/4" door thickness standard (can be ordered to accommodate doors 1-3/4" to 2-1/4" thick)
Keys	Two nickel silver cut keys per lock, 6-pin, S123 section

**Common pricing information**

1.	Locks are furnished with standard features unless otherwise specified.
2.	Door thickness is 1-3/4".
3.	Split finishes and designs will be priced at the highest list price of the design and/or finish.
4.	Engineering specials are denoted by a part number beginning with "X" and are not subject to standard discounting.
5.	⌚ denotes a lock or part that requires an extended lead time.
6.	👤 denotes a handed product and requires handing to be specified.
7.	For all restricted keyways (Everest B, D, 29R, and 29T, also Quad, Numbered, and Reversed) add \$31.00. This does not apply to Primus cylinders. See Terms and Conditions for ordering information and requirements.
8.	Locks, keys, and cylinders containing restricted keyways require additional documentation to order. See Terms and Conditions for ordering information and requirements.
9.	Keyway must be specified for keyed functions and cylinders. If not specified, default keyway will be S123 for KA (keyed alike), KD (keyed different), and O-bitted product and S145 for factory managed masterkey systems.
10.	Multiple keying options are available. Locks and cylinders are furnished KD unless otherwise specified or excepted by notation.
11.	Control Keys for permanent and construction cores are not included with the lock or cylinder and must be ordered separately.
12.	Locks specified with "C" keyway and KD or O-bitted will receive 6-pin cylinders (keyed 5) with 5-pin keys.
13.	Full Size Interchangeable Cores (FSIC) are furnished 1-bitted unless otherwise specified. If O-bitted is selected, the order will be entered as 1-bitted. This does not apply to FSIC Primus® cores.
14.	Conventional cylinders, Primus cylinders (conventional and FSIC) can be supplied O-bitted. If 1-bitted is selected, the order will be entered as O-bitted.
15.	Available plug face finishes are 606, 622, 626 and 643e.



HOW TO ORDER ■ LE MORTISE MOBILE ENABLED WIRELESS LOCK

SCHLAGE LOCKS  
COMMERCIAL WIRELESS ELECTRONIC  
COMMERCIAL MECHANICAL  
EXIT DEVICES  
DOOR CLOSERS  
ACCESSORIES

REQUIRED FIELDS				FACTORY DEFAULT AND OPTIONS										
LEB	MS	GRW	P6	03	626	00A	-	612	-	LH	10-136	134	S123	-

<b>1. Series</b>														
LEB	Mobile enabled mortise lock													
LEBSI	Mobile enabled mortise lock with HID Credential secure sector compatibility													
<b>2. Chassis/function</b>														
MS	Mortise with LED indicator													
MB	Mortise with push button and LED													
MD	Mortise Deadbolt with LED													
<b>3. Style</b>														
GRW	Greenwich sectional with rose													
ADD	Addison escutcheon													
<b>4. Cylinder type</b>														
P6	Mortise cylinder, Schlage 6-pin													
For all options see LE ordering pages														
<b>5. Outside lever<sup>1</sup></b>														
03	Suites with Tubular style													
LAT	Latitude													
For all options see LE ordering pages														
<sup>1</sup> To add tactile warning, use prefix 8. Example: 803														
<b>6. Outside finish</b>														
605	Bright Brass	622	Matte Black											
606	Satin Brass	625	Bright Chrome											
612	Satin Bronze	626	Satin Chrome											
619	Satin Nickel	643e	Aged Bronze											
626AM	Satin Chrome (Antimicrobial Coating)													
<b>7. Outside rose (specify only for Greenwich trim)</b>														
00A	2-1/8" (54 mm) diameter (Std.)													
00B	2-9/16" (65 mm) diameter													
00C	2-5/8" (66 mm) diameter with bevel													
AVA	Decorative rose 2-5/8" (66 mm) diameter, supports ACC lever only													
MER	Decorative rose 2-5/8" (66 mm) diameter, supports MER lever only													
<b>8. Inside lever (specify only if different from outside lever)</b>														
3	Suites with Tubular style													
LAT	Latitude													
For all options see LE ordering pages														
<b>9. Inside finish (specify only if different from outside finish)</b>														
See options under 6 above														
<b>10. Inside rose (specify only for Greenwich trim and only if different from Outside rose)</b>														
See options under 7 above														
<b>11. Handing</b>														
RH	Right handed (Std.)	RHR	Right handed reverse											
LH	Left handed	LHR	Left handed reverse											
<b>12. Strike plate lip length</b>														
10-316	1-3/16" lip length (Std. for MS/MB)													
10-316-112	1-1/2" lip length													
For all options see LE ordering pages														
<b>13. Door thickness</b>														
134	1-3/4" (Std.)													
Options available up to 2-1/4" thickness - see LE ordering pages														
<b>14. Keyway type</b>														
S123	Everest 29 S (Std.)													
For all options see LE ordering pages														
<b>15. Additional options</b>														



## HOW TO ORDER ■ NDE MOBILE ENABLED CYLINDRICAL WIRELESS LOCK

### Standard features



Certification	ANSI/BHMA Certified A156.25-2013, A156.2-2011, Series 4000, Grade 1, UL 294, UL 10C
Latch	1-1/8" x 2-1/4", Square corner faceplate, 1" housing diameter, 1/2" throw
Strike	1-1/4" x 4-7/8", ANSI Square corner, no box
Backset	2-3/4"
Cylinder	6-pin solid brass, keyed 6-pin, S123 keyway, keyed different (KD)
Door range	Comes set for 1-3/4" thick doors. Can be field adjusted for doors 1-5/8"-2" thick
Keys	Two nickel silver cut keys per lock, 6-pin, S123 section

### Common pricing information

1.	Locks are furnished with standard features unless otherwise specified.
2.	Door thickness is 1-3/4".
3.	Split finishes and designs will be priced at the highest list price of the design and/or finish.
4.	Engineering specials are denoted by a part number beginning with "X" and are not subject to standard discounting.
5.	∞ denotes a lock or part that requires an extended lead time.
6.	For all restricted keyways (Everest B, D, 29R, and 29T, also Quad, Numbered, and Reversed) add \$31.00. This does not apply to Primus cylinders. See Terms and Conditions for ordering information and requirements.
7.	Locks, keys, and cylinders containing restricted keyways require additional documentation to order. See Terms and Conditions for ordering information and requirements.
8.	Keyway must be specified for keyed functions and cylinders. If not specified, default keyway will be S123 for KA, KD, and 0-bitted product and S145 for Factory managed masterkey systems.
9.	Multiple keying options are available. Locks and cylinders are furnished KD unless otherwise specified or excepted by notation.
10.	Control Keys for permanent and construction cores are not included with the lock or cylinder and must be ordered separately.
11.	Locks specified with "C" keyway and KD or 0-bitted will receive 6-pin cylinders (keyed 5) with 5-pin keys.
12.	Full Size Interchangeable Cores (FSIC) are furnished 1-bitted unless otherwise specified. If 0-bitted is selected, the order will be entered as 1-bitted. This does not apply to FSIC Primus® cores.
13.	Conventional cylinders, Primus cylinders (conventional and FSIC) can be supplied 0-bitted. If 1-bitted is selected, the order will be entered as 0-bitted.
14.	Available plug face finishes are 606, 622, 626, and 643e.



HOW TO ORDER ■ NDE MOBILE ENABLED CYLINDRICAL WIRELESS LOCK

REQUIRED FIELDS	FACTORY DEFAULT AND OPTIONS
NDEB . J . LAT . 626AM . SPA . 605 . 13-247 . 47267101 . S123 . K510-066	

1. Series (Vandlgard only)

- NDEB Mobile enabled cylindrical lock (with interior pushbutton with indicator)
- NDEBSI Mobile enabled cylindrical lock with HID credential secure sector compatibility (with interior pushbutton with indicator)

2. Cylinder type

- P6 Schlage KIL format
- For all options see NDE ordering pages

3. Outside lever<sup>1</sup>

- ATH Athens
- BRK Boardwalk
- BRW Broadway
- LAT Latitude
- LON Longitude
- OME Omega
- RHO Rhodes
- SPA Sparta
- TLR Tubular

<sup>1</sup> Tactile warning available - see lever options

4. Outside finish

- |       |                                      |      |               |
|-------|--------------------------------------|------|---------------|
| 605   | Bright Brass                         | 622  | Matte Black   |
| 606   | Satin Brass                          | 625  | Bright Chrome |
| 612   | Satin Bronze                         | 626  | Satin Chrome  |
| 619   | Satin Nickel                         | 643e | Aged Bronze   |
| 626AM | Satin Chrome (Antimicrobial Coating) |      |               |

5. Inside lever (specify only if different from outside lever)

- See options under 3 above
- Omega (OME) levers are very close to the escutcheon when rotated – consider Sparta (SPA) levers as a substitute
- Tactile levers not available for inside lever

6. Inside finish (specify only if different from outside lever)

See options under 4 above

7. Latch

- 13-247 2-3/4" backset; 1/2" throw bolt; 1-1/8" x 2-1/4" faceplate (standard for both series)
- For all options see NDE ordering pages

8. Strike

- NDEB 47267101 – 1-1/4" x 4-7/8" with 1-3/16" lip (10-025 with retained screws)
- For all options see NDE ordering pages

9. Keyway

- S123 Everest 29 (standard for both series)
- For all options see NDE ordering pages

10. Additional options

For all options see NDE ordering pages

SCHLAGE LOCKS

COMMERCIAL WIRELESS ELECTRONIC

COMMERCIAL MECHANICAL

EXIT DEVICES

DOOR CLOSERS

ACCESSORIES



HOW TO ORDER ■ CTE ENGAGE™ SINGLE DOOR CONTROLLER

REQUIRED FIELDS	COLOR	COVER STYLE
CTE - MTB15	B	C2

**1. CTE**

**2. Reader type**

- MTB11 Mobile enabled multi-technology mullion mount
- MTB15 Mobile enabled multi-technology single gang wall mount

**3. Reader cover color option**

- B Black (Standard for C1 and C2)
- C Cream (Available for C1 cover only)

**4. Reader cover style**

- C1 Legacy style cover (Black or Cream color options)
- C2 New style cover (Default cover; Black is only color option)



LOCKS

EXIT DEVICES

DOOR CLOSERS

ARCHITECTURAL HARDWARE

OVERHEAD STOPS & HOLDERS

HOW TO ORDER

HOW TO ORDER ■ ND SERIES

Ordering procedures



**Standard features**

Certifications	ANSI/BHMA Certified A156.2-2011, Series 4000, Grade 1, UL Listed for 3-hour fire door
Latch	1-1/8" x 2-1/4", square corner faceplate, 1" housing diameter, 1/2" throw
Strike	1-1/4" x 4-7/8", ANSI square corner, no box
Backset	2-3/4"
Cylinder	6-pin solid brass, keyed 6-pin, S123 keyway, keyed different (KD)
Door range	1-5/8" – 2-1/8" for all functions except ND85; 1-3/4" – 2" for ND85
Keys	Two nickel silver cut keys per lock, 6-pin, S123 section

To order Schlage products, descriptive data should be in the same sequence as shown below.

Line Item	Qty	Product	Outside		Inside		Hand	Latch	Strike	Dr Thk	Ext	DIM	Additional details
			DES	FIN	DES	FIN							
1	10	ND53PD	RHO	622	OME	-	-	13-247	10-025	214	EE	138	KA

- Line Item:** Line item number
- Qty:** Quantity
- Product:** Product function + Cylinder code
- Outside Des:** Outside lever design
- Outside Fin:** Outside finish
- Inside Des:** Inside lever design: Specify only if different from the outside lever design
- Inside Fin:** Inside lever finish: Specify only if different from the outside finish
- Hand:** Hand of door: N/A for ND lock
- Latch:** Product latch: Leave blank for standard latch or specify part number if non-standard latch is required.
- Strike:** Product strike: Leave blank for standard strike or specify part number if non-standard strike is required.
- Dr Thk:** Door thickness: Enter door thickness if non-standard.  
Example: 138=1-3/8", 214=2-1/4"
- Ext:** Extension: Enter for doors 2 1/8" or greater.  
Example: EE=extended equally, EI=extended inside, EO=extended outside, ED=extended differently
- Dim:** Dimension: Enter only for non-standard strike lip length
- Additional details:** Enter additional detail for keying information or special requirements

**Common pricing information**

1. Locks are furnished with standard features unless otherwise specified.
2. Door thickness is 1-3/4" unless otherwise specified.
3. Split finishes and designs will be priced at the highest list price of the design and/or finish.
4. ⌘ denotes a lock or part that requires an extended lead time.
5. ⌚ denotes a handed product and requires handing to be specified.
6. For all restricted keyways (Everest D, Everest 29 T, Quad, Numbered, Reversed) add \$31.00. This does not apply to Primus cylinders. See Terms and Conditions for ordering information and requirements.
7. Locks, keys and cylinders containing restricted keyways require additional documentation to order. Please see Terms and Conditions for the specific requirements.
8. Keyway must be specified for keyed functions and cylinders. If not specified, default keyway will be S123 for KA, KD and 0-bitted product and S145 for Factory managed masterkey systems.
9. Multiple keying options are available. Locks and cylinders are furnished KD unless otherwise specified or excepted by notation.
10. Control Keys for permanent and construction cores are not included with the lock or cylinder and must be ordered separately.
11. Locks specified with "C" keyway and KD or 0-bitted will receive 6-pin cylinders.
12. Full Size Interchangeable Cores (FSIC) are furnished 1-bitted unless otherwise specified. If 0-bitted is selected, the order will be entered as 1-bitted. This does not apply to FSIC Primus® cores.
13. Conventional cylinders, Primus cylinders (conventional and FSIC) can be supplied 0-bitted. If 1-bitted is selected, the order will be entered as 0-bitted.
14. Available plug face finishes are 606, 622, 626, 643e.
15. Locks and cylinders will be furnished with 2 keys each as standard. Additional keys will be charge at the additional cut keys charge appropriate for the cylinder/key type

SCHLAGE LOCKS  
COMMERCIAL WIRELESS ELECTRONIC  
COMMERCIAL MECHANICAL  
EXIT DEVICES  
DOOR CLOSERS  
ACCESSORIES

HOW TO ORDER ■ L SERIES

Ordering procedures



**Standard features**

Certification	L/LV9000: ANSI/BHMA Certified A156.13-2012, Series 1000, Grade 1 Operational, Grade 1 Security, UL Listed for 3-hour fire door (except L9076 and L9077). With FSIC Interchangeable Core Cylinders: Grade 1 Operational, Grade 2 Security. With SFIC Interchangeable Core Cylinders: Grade 1 Operational, Grade 3 Security. L400: ANSI/BHMA Certified A156.36-2010, Grade 1, UL Listed for 3-hour fire door.
Case size	L/LV9000: 4-7/16" x 6-1/16" x 1"; L400: 4-7/16" x 3-5/8" x 1"
Armor front	L/LV9000: 1-1/4" x 8"; L400: 1-1/4" x 5-9/16"
Deadbolt	1" Throw stainless steel
Latch bolt	3/4" Throw stainless steel with anti-friction tongue
Strike	L/LV9000: 1-1/4" x 4-7/8" Square corner, 1-3/16" lip, box; L400: 1-1/8" x 3-5/8" square corner, box
Backset	2-3/4"
Cylinder	6-Pin solid brass, keyed 6-pin, S123 keyway, keyed different (KD)
Door range	1-3/4"
Keys	Two nickel silver cut keys per lock, 6-pin, S123 section

To order Schlage products, descriptive data should be in the same sequence as shown below.

Line Item	Qty	Product	Outside		Inside		Hand	Latch	Strike	Dr Thk	Ext	DIM	Additional details
			DES	FIN	DES	FIN							
1	10	L9050P	12A	626	06B	613	RH	09-669	10-072	2	EE	134	KA

- Line Item:** Line item number
- Qty:** Quantity
- Product:** Product function + cylinder code
- Outside Des:** Outside lever design + rose/escutcheon code
- Outside Fin:** Outside finish
- Inside Des:** Inside lever design + rose/escutcheon code, specify only if different from the outside lever design
- Inside Fin:** Inside lever finish, specify only if different from the outside finish
- Hand:** Hand of door, specify only for handed lever designs or for LM9300 MultiPoint lock
- Latch:** Product armor front, leave blank for standard armor or specify part number if non-standard armor is required.  
LLL = less armor front
- Strike:** Product strike, leave blank for standard strike or specify part number if non-standard strike is required. LLL = less strike
- Dr Thk:** Door thickness, leave blank for standard thickness (1-3/4") or specify if non-standard. Example: 138 = 1-3/8", 214 = 2-1/4"
- Ext:** Extension, enter one of the following when door thicknesses 2" or greater are specified:  
EE = Extended Equally, EI = Extended Inside, EO = Extended Outside
- Dim:** Dimension; for locks enter only for non-standard strike lip length, for parts enter for non-standard strike lip length, mortise cylinder or blocking ring length
- Additional details:** Enter additional detail for keying information or special requirements

**Common pricing information**

1. Locks are furnished with standard features unless otherwise specified.
2. Door thickness is 1-3/4" unless otherwise specified.
3. Split finishes and designs will be priced at the highest list price of the design and/or finish.
4. ⌘ denotes a lock or part that requires an extended lead time.
5. ⌘ denotes a handed product and requires handing to be specified.
6. For all restricted keyways (Everest D, Everest 29 T, Quad, Numbered, Reversed) add \$31.00. This does not apply to Primus cylinders. See Terms and Conditions for ordering information and requirements.
7. Locks, keys and cylinders containing restricted keyways require additional documentation to order. Please see Terms and Conditions for the specific requirements.
8. Keyway must be specified for keyed functions and cylinders. If not specified, default keyway will be S123 for KA, KD and 0-bitted product and S145 for Factory managed masterkey systems.
9. Multiple keying options are available. Locks and cylinders are furnished KD unless otherwise specified or excepted by notation.
10. Control Keys for permanent and construction cores are not included with the lock or cylinder and must be ordered separately.
11. Locks specified with "C" keyway and KD or 0-bitted will receive 6-pin cylinders.
12. Full Size Interchangeable Cores (FSIC) are furnished 1-bitted unless otherwise specified. If 0-bitted is selected, the order will be entered as 1-bitted. This does not apply to FSIC Primus® cores.
13. Conventional cylinders, Primus cylinders (conventional and FSIC) can be supplied 0-bitted. If 1-bitted is selected, the order will be entered as 0-bitted.
14. Available plug face finishes are 606 and 626. For brass or bronze finish colors, the plug face finish is 606. For chrome, nickel or stainless steel finish colors, the plug face finish is 626.
15. Locks and cylinders will be furnished with 2 keys each as standard. Additional keys will be charge at the additional cut keys charge appropriate for the cylinder/key type

HOW TO ORDER ■ ALX SERIES

Ordering procedures



**Standard features**

Certification	ANSI/BHMA Certified A156.2-2011, Series 4000, Grade 2, UL Listed for 3-hour fire door
Latch	1-1/8" x 2-1/4" Square corner faceplate, 7/8" housing diameter with 1" diameter sleeve, 1/2" throw
Strike	1-1/4" x 4-7/8" ANSI, square corner, no dust box
Backset	2-3/4"
Cylinder	6-pin solid brass, keyed 6-pin, S123 keyway, keyed different (KD)
Door range	1-3/8" – 1-3/4"
Keys	Two nickel silver cut keys per lock, 6-pin, S123 section

To order Schlage products, descriptive data should be in the same sequence as shown below.

Line Item	Qty	Product	Outside		Inside		Hand	Latch	Strike	Dr Thk	Ext	DIM	Additional details
			DES	FIN	DES	FIN							
1	10	ALX53PD	SAT	626	OME	619	-	47267043	10-025	-	-	-	-

- Line Item:** Line item number
- Qty:** Quantity
- Product:** Product function + Cylinder code
- Outside Des:** Outside lever design
- Outside Fin:** Outside finish
- Inside Des:** Inside lever design: Specify only if different from the outside lever design
- Inside Fin:** Inside lever finish: Specify only if different from the outside finish
- Hand:** Hand of door: N/A for ALX lock
- Latch:** Product latch: Leave blank for standard latch or specify part number if non-standard latch is required.
- Strike:** Product strike: Leave blank for standard strike or specify part number if non-standard strike is required.
- Dr Thk:** 1-3/8" through 1-3/4"
- Dim:** Dimension: Enter only for non-standard strike lip length
- Additional details:** Enter additional detail for keying information or special requirements

**Common pricing information**

1. Locks are furnished with standard features unless otherwise specified.
2. Door thickness is 1-3/4" unless otherwise specified.
3. Split finishes and designs will be priced at the highest list price of the design and/or finish.
4. ⌘ denotes a lock or part that requires an extended lead time.
5. 🔄 denotes a handed product and requires handing to be specified.
6. For all restricted keyways (Everest D, Everest 29 T, Quad, Numbered, Reversed) add \$31.00. This does not apply to Primus cylinders. See Terms and Conditions for ordering information and requirements.
7. Locks, keys and cylinders containing restricted keyways require additional documentation to order. Please see Terms and Conditions for the specific requirements.
8. Keyway must be specified for keyed functions and cylinders. If not specified, default keyway will be S123 for KA, KD and 0-bitted product and S145 for Factory managed masterkey systems.
9. Multiple keying options are available. Locks and cylinders are furnished KD unless otherwise specified or excepted by notation.
10. Control Keys for permanent and construction cores are not included with the lock or cylinder and must be ordered separately.
11. Locks specified with "C" keyway and KD or 0-bitted will receive 6-pin cylinders.
12. Full Size Interchangeable Cores (FSIC) are furnished 1-bitted unless otherwise specified. If 0-bitted is selected, the order will be entered as 1-bitted. This does not apply to FSIC Primus® cores.
13. Conventional cylinders, Primus cylinders (conventional and FSIC) can be supplied 0-bitted. If 1-bitted is selected, the order will be entered as 0-bitted.
14. Available plug face finishes are 606, 622, 626, 643e.
15. Locks and cylinders will be furnished with 2 keys each as standard. Additional keys will be charge at the additional cut keys charge appropriate for the cylinder/key type



## HOW TO ORDER COMMERCIAL MECHANICAL LOCKS ■ FALCON

To order Falcon products, descriptive data should be in the same sequence as shown:

Line Item	Qty	Product	Outside		Inside		Hand	Latch	Strike	Dr Thk	Ext	DIM	Additional details
			DES	FIN	DES	FIN							
1	2	3	4	5	6	7	8	9	10	11	12	13	14

1. **LINE ITEM:** Line item number
2. **QTY:** Quantity
3. **PRODUCT:** Complete lock product or part number
4. **OUTSIDE DES:** Outside design code
5. **OUTSIDE FIN:** Outside finish code
6. **INSIDE DES:** Inside design code. Leave blank if same as outside design code.
7. **INSIDE FIN:** Inside finish code. Leave blank if same as outside finish code.
8. **HAND:** Hand of door. Only one hand allowed per line item.
  - Example: RH=Right Hand, LH=Left Hand, RR=Right Reverse, LR=Left Reverse.

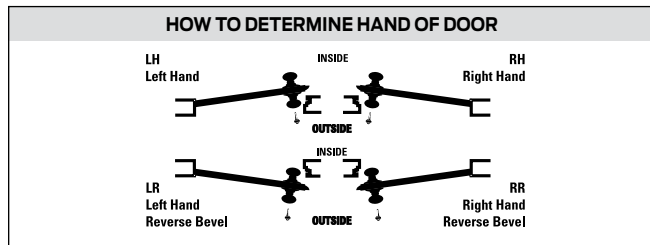

9. **LATCH:** Latch. Leave blank for standard or specify part number if non-standard latch is required. LLL=Less Latch.
10. **STRIKE:** Strike. Leave blank for standard or specify part number if non-standard strike is required. LLL=Less Strike.
11. **DR THK:** Door Thickness. Enter door thickness if non-standard.
  - Example: 138=1-3/8", 214=2-1/4", 212=2-1/2".
12. **EXT:** Extension. Enter one of the following when doors 2" thick or greater are specified:
  - EE = Extended Equally
  - EI = Extended Inside
  - EO = Extended Outside
  - ED = Extended Differently
  - EI or EO assumes the latch will be centered on a 1-3/4" door, to which material has been added.
13. **DIM:** Enter dimension for non-standard strike lip length and mortise cylinder or blocking ring length.
  - 012 = 1/8"    118 = 1-1/8"
  - 018 = 3/16"    114 = 1-1/4"
  - 025 = 1/4"    138 = 1-3/8"
  - 031 = 5/16"    112 = 1-1/2"
  - 037 = 3/8"    158 = 1-5/8"
  - 050 = 1/2"    134 = 1-3/4"
  - 078 = 7/8"    200 = 2"
  - 100 = 1"    400 = 4"
14. **ADDITIONAL DETAILS:** Enter detail for keying information and for special requirements.

HOW TO ORDER EXIT DEVICES ■ VON DUPRIN

EL - 98 - 27 - L - F - - 626 - 3' - RHR - LBR - 996/ 299F/ 626 - 06 - SNB - HM

**Prefixes**

None	Standard	PN	Pneumatic latch retraction
AX	Accessible device	QEL	Quiet electric latch retraction
CD	Cylinder dogging (panic only)	RX	Request-to-exit
CX	Chexit	RX2	Double request-to-exit
E	Electric locking mortise/lever	SD	Special dogging (panic only)
EL	Electric latch retraction	SS	Signal switch
HH	Hurricane device	WS	Windstorm (FEMA rated)
LX	Latch bolt monitoring		surface vertical rod exit device
PL	Pullman latch	XP	Heavy protection - rim

**Device series**

22	Push bar device	88	Cross bar device
33A/35A	Push bar device	94/95	Recessed device
55	Cross bar device	98/99	Push bar device

**Device type**

None	Rim device	49	Concealed vertical cable device (see CVC How to Order form)
27	Surface mounted vertical rod device		
47	Concealed vertical rod device	50WDC	Concealed vertical rod wood door device
47WDC	Concealed vertical rod wood door device	57	Three-point latch device
		75	Mortise lock device
48	Concealed vertical rod device		

**Trim function**

XX	AD Trim (to come from client)	L-BE	Lever - blank escutcheon
DT	Dummy trim	L-DT	Lever, rigid - dummy trim
EO	Exit only	L-NL	Lever, rigid - night latch
HL	Hospital pull trim	NL	Night latch
K	Knob	NL-OP	Night latch cylinder assembly, optional pull
K-BE	Knob - blank escutcheon	TL	Turn lever
K-DT	Knob, rigid - dummy trim	TL-BE	Turn lever - blank escutcheon
K-NL	Knob, rigid - night latch	TP	Thumbpiece
L	Lever (Classroom)	TP-BE	Thumbpiece - blank escutcheon

**Rating**

F	Fire exit hardware	Blank	Panic exit hardware
---	--------------------	-------	---------------------

**Suffix**

-2	Double cylinder	-2SI	Double cylinder with security indicator
----	-----------------	------	---

**Finish**

605	612	625	626AM	630	643e	711
606	619	626	628	630AM	710	

**Door width**

3'	Standard default	1-3/4"	Standard
4'		2-1/4"	Optional
2'			

**Door thickness**

**Handing**

RHR	Right hand reverse	LHR	Left hand reverse
-----	--------------------	-----	-------------------

**Less bottom rod/Cable**

LBR	Less bottom rod	LBR-AFL	Less bottom rod with fire pin
LBL	Less bottom cable	LBL-AFL	Less bottom cable with fire pin

**Trim options/finish**

See trim options/finish for each series

**Lever style**

06 Standard  
Optional lever styles available

**Accessories**

CYL	Cylinder	SNB	Sex bolts	AMS	All machine screws
SK	Shim kit	SLM	SLM blocking		

**Other miscellaneous door information**

BRAILLE	Vision impaired touchpad, raised letter, and braille	SG	Safety glow	AL	Aluminum door	SC	Steelcraft (HH device only)
		CE	CE Labeled	HM	Hollow metal door	D	Double egress
PUSH	Touchbar trim embossed 'PUSH'	LCP	Less cover plate	WD	Wood door	P	Pair of doors
RSS	Red silk-screened lettered touchbar trim	10WDA	#10WDA Cover plate	CP	Composite door	S	Single door
		RAT REL	Ratchet release assy	INS2	Insulclad - 1/2"		
KN	Knurled touch bar	WH	Weep holes	INS4	Insulclad - 1/4"		

Note: Not all options are listed. Not all options are available on all series. See the specific series pages for complete options available. Please contact customer care for questions.

SCHLAGELOCKS  
COMMERCIAL WIRELESS ELECTRONIC  
COMMERCIAL MECHANICAL  
EXIT DEVICES  
DOOR CLOSERS  
ACCESSORIES

## HOW TO ORDER EXIT DEVICES ■ FALCON

**MEL- F - 25 - V - L-DANE - 605 - 3' - LHR- LBR- SNB- WD**

### Prefixes

AX	Accessible device (25 and 19 Series only)
CD	Cylinder dogging
LD	Less dogging
RX	Touchbar Request-to-Exit
DM	Latch bolt monitor switch - when fully extended
LM	Latch bolt monitor switch - when fully retracted
KOR	Key bypass switch
MEL	Motorized electric latch retraction
FSA	Electric lock or unlock trim-Fail Safe (25 Series only)
FSE	Electric lock or unlock trim-Fail Secure (25 Series only)
EA	Exit alarm

### Rating

F	Fire exit hardware
Blank	Panic exit hardware

### Device series

19	Touch bar device, narrow stile
24	Touch bar device, narrow stile
25	Touch bar device

### Device type

R	Rim	C	Concealed vertical rod
V	Surface vertical rod	C-WDC	Concealed vertical rod (Wood door)
M	Mortise		

### Trim function (see Trim pages for all functions)

EO	Exit only	K	Knob
DT	Dummy trim	L	Lever (Dane standard)
NL	Night latch	TL	Thumb lever
C	Cylinder trim plate	NL-OP	Night latch pull by other
TP	Thumbpiece	KIL	Key-In-Lever

### Finish

605	612	619 <sup>1</sup>	625	629	689	
606	643e <sup>1</sup>	622 <sup>1</sup>	626	630	695	710

### Door width

### Door thickness

3'	Standard default	1-3/4"	Standard
4'		2-1/4"	Optional
2'	(Less label)		

### Handing

RHR	Right hand reverse
LHR	Left hand reverse

### Less bottom rod

LBR	Less bottom rod
LBR-AFL	Less bottom rod with Auxiliary fire pin

### Accessories

CYL	Cylinder	SNB	Sex bolts	AMS	All machine screws
SK	Shim kit	SLM	SLM blocking		

### Other miscellaneous door information

HMD	Hollow metal door	SCDC	Steel channel door construction	-	Door label (20 min, 45 min, 90 min 1-1/2 hr)
HMF	Hollow metal frame	-	Specify other door or frame material information	-	Stile width
WD	Wood door			-	Frame stop height
WDF	Wood frame	-	Door height	SGL	Single door
ALD	Aluminum door	-	Door thickness	PR	Pair of doors swinging same direction
ALF	Aluminum frame	-	Door undercut	DE	Double egress doors
CPD	Composite door			CON	Allegion Connect

<sup>1</sup> 619, 622, and 643e finishes are available on select 24 and 25 Series.  
Not all options are available on all series, consult customer service.

For Special Order Product Quotes: Email: [VDI\\_specials@allegion.com](mailto:VDI_specials@allegion.com) Fax: 1-877-730-6248

## HOW TO ORDER TRIM ■ FALCON

510 - L - R - 606 - LHR - DAN - FSE - CYL

### Trim series

D24 Series	D25 Series	19 Series	XX Series
711	510	911	711
712	511	912	712
715	512	914	717
717	513	917	718
718	717	918	810
	718	920	811
		930	812
			815
			816
			820

### Trim function (see Trim pages for all functions)

EO	Exit only	NL	Night latch
DT	Dummy trim	C	Cylinder trim less pull
TP	Thumbpiece	K	Knob
L	Lever (Dane standard)	KIL	Key-In-Lever
TL	Thumb lever		

### Device type

R	Rim	V	Surface vertical rod
M	Mortise	C	Concealed vertical rod (includes WDC)

### Finish

605	612	643e <sup>1</sup>	622 <sup>1</sup>	626	695	
606	613	619 <sup>1</sup>	625	689	629	630

### Handing

RHR	Right hand reverse
LHR	Left hand reverse

### Lever style

DANE	(DAN) (supplied standard if not specified)	BROADWAY	(BRW <sup>1</sup> ) (available on 24 and 25 Series only)
SUTRO	(SUT)	DANISH	(DSH <sup>1</sup> ) (available on 24 and 25 Series only)
QUANTUM	(QUA)	LATITUDE	(LAT <sup>1</sup> ) (available on 24 and 25 Series only)
AVALON	(AVA) (available on 24, 25, and xx Series only)	LONGITUDE	(LON <sup>1</sup> ) (available on 24 and 25 Series only)
BOARDWALK	(BRK <sup>1</sup> ) (available on 24 and 25 Series only)		

### Trim options

FSA	Electric lock or unlock-Fail Safe (FSA device required)
FSE	Electric lock or unlock-Fail Secure (FSE device required)
CON	Allegion Connect

### Other information or accessories

CYL	Include cylinder with trim
KD	Cylinder keyed different

### Door thickness

Specify door thickness other than 1-3/4".

<sup>1</sup> Finishes and levers available on select 24 and 25 Series.

HOW TO ORDER SURFACE DOOR CLOSERS ■ LCN

For additional information on how to order specific closers, please see the 'How to Order' page in each individual closer section of the LCN General Catalog or call LCN Customer Care.

1250 Series

		Cylinder	Cover	Arm	Finish	Options	Accessories
<b>CYL</b>	Standard cylinder assembly						
<b>LESSCOV</b>	Less cover (Default)						
<b>SLIMPC</b>	Slim line plastic cover						
<b>RW62A</b>	Regular arm with 62A auxiliary shoe			<b>HEDA</b>	Hold open extra duty arm		
<b>RWPA</b>	Regular with parallel arm bracket			<b>CUSH</b>	Cush-n-stop arm		
<b>LONG</b>	Long arm			<b>HCUSH</b>	Hold open cush-n-stop arm		
<b>HWPA</b>	Hold open with parallel arm bracket			<b>SCUSH</b>	Spring cush-n-stop arm		
<b>HLONG</b>	Hold open long arm			<b>SHCUSH</b>	Spring hold open cush-n-stop arm		
<b>EDA</b>	Extra duty arm						
<b>622</b>	Matte black (MTBLK)		<b>693</b>		Gloss black (GLBLK)		
<b>689</b>	Aluminum (AL)		<b>695</b>		Dark bronze (DKBRZ)		
<b>690</b>	Statuary bronze (STAT)		<b>696</b>		Brass (BRASS)		
<b>691</b>	Light bronze (LTBRZ)						
<b>SRI</b>	Special rust inhibitor for powder coat finishes						
<b>UNIV</b>	Universal screws (Default screw package)						
<b>TORX</b>	Torx machine screws						
<b>TBTRX</b>	Through bolt wood and Torx machine screws (Specify door thickness if other than 1 ¾")						
<b>BAA</b>	Buy America Act (Only specify when BAA is required for 1250 with RWPA or HWPA arms in 689 or 695)						
<b>1250-18</b>	Plate		<b>1250-61</b>		Blade stop spacer		
<b>1250-18PA</b>	Plate		<b>1250-62A</b>		Auxiliary shoe		
<b>1250-30</b>	CUSH Shoe support		<b>1250-419</b>		PA Flush panel adapter		

1260 Series

		Cylinder	Cover	Arm	Finish	Options	Accessories
<b>CYL</b>	Standard cylinder assembly						
<b>LESSCOV</b>	Less cover (Default)						
<b>SLIMPC</b>	Slim line plastic cover						
<b>RWPA</b>	Regular with parallel arm bracket			<b>HLONG</b>	Hold open long arm		
<b>LONG</b>	Long arm			<b>EDA</b>	Extra duty arm		
<b>RW62A</b>	Regular arm with 62A auxiliary shoe			<b>HEDA</b> <sup>☞</sup>	Hold open extra duty arm (Optional -62G)		
<b>H</b>	Hold open			<b>CUSH</b>	Cush-n-stop arm		
<b>HWPA</b>	Hold open with parallel arm bracket			<b>HCUSH</b>	Hold open cush-n-stop arm		
<b>622</b>	Matte black (MTBLK)		<b>693</b>		Gloss black (GLBLK)		
<b>689</b>	Aluminum (AL)		<b>695</b>		Dark bronze (DKBRZ)		
<b>690</b>	Statuary bronze (STAT)		<b>696</b>		Brass (BRASS)		
<b>691</b>	Light bronze (LTBRZ)						
<b>SRI</b>	Special rust inhibitor for powder coat finishes						
<b>SRT</b>	Self reaming and tapping screws (Default screw package)						
<b>TBSRT</b>	Through bolt self reaming and tapping screws (Specify door thickness if other than 1 ¾")						
<b>WMS</b>	Wood and machine screws						
<b>TBWMS</b>	Through bolt wood and machine screws (Specify door thickness if other than 1 ¾")						
<b>TORX</b>	Torx machine screws						
<b>TBTRX</b>	Through bolt wood and Torx machine screws (Specify door thickness if other than 1 ¾")						
<b>1260-18</b>	Plate		<b>1260-62A</b>		Auxiliary shoe		
<b>1260-18PA</b>	Plate		<b>1260-419</b>		PA Flush panel adapter		
<b>1260-30</b>	CUSH Shoe support		<b>1260-18QF</b>		Quick Fix™ bracket kit		
<b>1260-61</b>	Blade stop spacer						

☞ Specify handing.

1450 Series

		Cylinder	Cover	Arm	Finish	Options	Accessories
<b>CYL</b>	Cast aluminum cylinder assembly (Default)						
<b>CYLDEL</b>	Delay action cylinder						
<b>SLIMPC</b>	Slim line plastic cover (Default)						
<b>FPC</b>	Full plastic cover						
<b>RWPA</b>	Regular with parallel arm bracket						
<b>LONG</b>	Long arm						
<b>RW62A</b>	Regular arm with 62A auxiliary shoe						
<b>HWPA</b>	Hold open with parallel arm bracket						
<b>HLONG</b>	Hold open long arm						
<b>EDA</b>	Extra duty arm						
<b>622</b>	Matte black (MTBLK)						
<b>689</b>	Aluminum (AL)						
<b>690</b>	Statuary bronze (STAT)						
<b>691</b>	Light bronze (LTBRZ)						
<b>RAL</b>	Custom powder coat finish (Requires metal cover)						
<b>MTLPC</b>	Brite metallic powder coat (Requires metal cover)						
<b>SRI</b>	Special rust inhibitor for powder coat finishes						
<b>UNIV</b>	Universal screws (Default screw package)						
<b>TORX</b>	Torx machine screws						
<b>TBTRX</b>	Through bolt wood and Torx machine screws (Specify door thickness if other than 1 3/4")						
<b>BAA</b>	Buy America Act (Only specify when BAA is required for 1250 with RWPA or HWPA arms in 689 or 695)						
<b>1450-18</b>	Plate						
<b>1450-18PA</b>	Plate						
<b>1450-30</b>	CUSH Shoe support						
		<b>1450-61</b>					
		<b>1450-62A</b>					
		<b>1450-419</b>					

☞ Specify handing.

1460 Series

		Cylinder	Cover	Arm	Finish	Options	Accessories
<b>CYL</b>	Cast aluminum cylinder assembly (Default)						
<b>CYLDEL</b>	Delay action cylinder						
<b>SLIMPC</b>	Slim line plastic cover (Default)						
<b>FPC</b>	Full plastic cover						
<b>RWPA</b>	Regular with parallel arm bracket						
<b>LONG</b>	Long arm						
<b>RW62A</b>	Regular arm with 62A auxiliary shoe						
<b>H</b>	Hold open						
<b>HWPA</b>	Hold open with parallel arm bracket						
<b>HD</b>	Heavy duty arm						
<b>HD62A</b>	Heavy duty with 62A auxiliary shoe						
<b>HDPA</b>	Heavy duty with parallel arm bracket						
<b>622</b>	Matte black (MTBLK)						
<b>689</b>	Aluminum (AL)						
<b>690</b>	Statuary bronze (STAT)						
<b>691</b>	Light bronze (LTBRZ)						
<b>693</b>	Gloss black (GLBLK)						
<b>695</b>	Dark bronze (DKBRZ)						
<b>696</b>	Brass (BRASS)						
<b>RAL</b>	Custom powder coat finish (Requires metal cover)						
<b>MTLPC</b>	Brite metallic powder coat (Requires metal cover)						
<b>SRI</b>	Special rust inhibitor for powder coat finishes						
<b>SRT</b>	Self reaming and tapping screws (Default screw package)						
<b>TBSRT</b>	Through bolt self reaming and tapping screws (Specify door thickness if other than 1 3/4")						
<b>WMS</b>	Wood and machine screws						
<b>TBWMS</b>	Through bolt wood and machine screws (Specify door thickness if other than 1 3/4")						
<b>TORX</b>	Torx machine screws						
<b>TBTRX</b>	Through bolt wood and Torx machine screws (Specify door thickness if other than 1 3/4")						
<b>1450-18</b>	Plate						
<b>1450-18DS</b>	Plate						
<b>1450-18FC</b>	Plate						
<b>1450-18PA</b>	Plate						
<b>1450-18PADS</b>	Plate						
		<b>1450-18PAFC</b>					
		<b>1450-30</b>					
		<b>1450-61</b>					
		<b>1450-62A</b>					
		<b>1450-419</b>					

☞ Specify handing.

4040XP Series

			Cylinder	Cover	Arm	Finish	Options	Accessories
<b>CYL</b>	Cast aluminum cylinder assembly (Default)							
<b>CYLDEL</b>	Delay action cylinder							
<b>PC</b>	Plastic cover (Default)							
<b>MC</b>	Metal cover (Included for plated finishes)							
<b>REGARM</b>	Regular arm	<b>EDA</b>						
<b>RWPA</b>	Regular with parallel arm bracket	<b>EDAW62G</b>						
<b>RW62A</b>	Regular arm with 62A auxiliary shoe	<b>HEDA</b>						
<b>LONG</b>	Long arm	<b>CUSH</b>						
<b>XLONG</b>	Extra long arm	<b>HCUSH</b>						
<b>H</b>	Hold open arm	<b>SCUSH</b>						
<b>HWPA</b>	Hold open with parallel arm bracket	<b>SHCUSH</b>						
<b>HLONG</b>	Hold open long arm							
<b>622</b>	Matte black (MTBLK)	<b>PLATED (INCLUDES METAL COVER)</b>						
<b>689</b>	Aluminum (AL)	<b>652</b>						
<b>690</b>	Statuary bronze (STAT)	<b>616</b>						
<b>691</b>	Light bronze (LTBRZ)	<b>632</b>						
<b>693</b>	Gloss black (GLBLK)	<b>633</b>						
<b>695</b>	Dark bronze (DKBRZ)	<b>639</b>						
<b>696</b>	Brass (BRASS)	<b>646</b>						
		<b>651</b>						
<b>RAL</b>	Custom powder coat finish (Requires metal cover)							
<b>MTLPC</b>	Brite metallic powder coat (Requires metal cover)							
<b>SRI</b>	Special rust inhibitor for powder coat finishes							
<b>SRT</b>	Self reaming and tapping screws (Default screw package)							
<b>TBSRT</b>	Through bolt self reaming and tapping screws (Specify door thickness if other than 1 3/4")							
<b>WMS</b>	Wood and machine screws							
<b>TBWMS</b>	Through bolt wood and machine screws (Specify door thickness if other than 1 3/4")							
<b>TORX</b>	Torx machine screws							
<b>TBTRX</b>	Through bolt wood and Torx machine screws (Specify door thickness if other than 1 3/4")							
<b>4040XP-18</b>	Plate	<b>4040XP-30</b>						
<b>4040XP-18TJ</b>	Plate	<b>4040XP-61</b>						
<b>4040XP-18G</b>	Plate	<b>4040XP-62A</b>						
<b>4040XP-18PA</b>	Plate	<b>4040XP-419</b>						

Specify handing.

4050A Series

			Cylinder	Cover	Arm	Finish	Options	Accessories
<b>CYL</b>	Cast aluminum cylinder assembly (Default)							
<b>CYLDEL</b>	Delay action cylinder							
<b>PC</b>	Plastic cover (Default)							
<b>MC</b>	Metal cover							
<b>REGARM</b>	Regular arm	<b>EDA</b>						
<b>RWPA</b>	Regular with parallel arm bracket	<b>HEDA</b>						
<b>LONG</b>	Long arm	<b>CUSH</b>						
<b>H</b>	Hold open	<b>HCUSH</b>						
<b>HWPA</b>	Hold open with parallel arm bracket	<b>SCUSH</b>						
<b>HLONG</b>	Hold open long arm	<b>SHCUSH</b>						
<b>622</b>	Matte black (MTBLK)	<b>693</b>						
<b>689</b>	Aluminum (AL)	<b>695</b>						
<b>690</b>	Statuary bronze (STAT)	<b>696</b>						
<b>691</b>	Light bronze (LTBRZ)							
<b>RAL</b>	Custom powder coat finish (Requires metal cover)							
<b>MTLPC</b>	Brite metallic powder coat (Requires metal cover)							
<b>SRI</b>	Special rust inhibitor for powder coat finishes							
<b>SRT</b>	Self reaming and tapping screws (Default screw package)							
<b>TBSRT</b>	Through bolt self reaming and tapping screws (Specify door thickness if other than 1 3/4")							
<b>WMS</b>	Wood and machine screws							
<b>TBWMS</b>	Through bolt wood and machine screws (Specify door thickness if other than 1 3/4")							
<b>TORX</b>	Torx machine screws							
<b>TBTRX</b>	Through bolt wood and Torx machine screws (Specify door thickness if other than 1 3/4")							
<b>4050A-18</b>	Plate	<b>4050A-61</b>						
<b>4050A-18G</b>	Plate	<b>4050A-62A</b>						
<b>4050A-18PA</b>	Plate	<b>4050A-419</b>						
<b>4050A-30</b>	CUSH Shoe support							

Specify handing.

## HOW TO ORDER SURFACE DOOR CLOSERS ■ FALCON

### SC60A Series

		Cylinder	Cover	Arm	Finish	Accessories
<b>CYL</b>	Cast aluminum cylinder assembly (Default)					
<b>LESSCOV</b>	Less cover (Default)					
<b>SLIMPC</b>	Slim line plastic cover					
<b>RWPA</b>	Regular arm with parallel arm bracket					
<b>HWPA</b>	Hold open arm with parallel arm bracket					
<b>HDP A</b>	Heavy duty arm with parallel arm bracket					
<b>DS</b>	Dead stop arm					
<b>DSHO</b>	Dead stop hold open arm					
<b>SS</b>	Spring stop arm					
<b>SSHO</b>	Spring stop hold open arm					
<b>622</b>	Matte black (MTBLK)					
<b>689</b>	Aluminum (AL)					
<b>695</b>	Dark bronze (DKBRZ)					
<b>696</b>	Brass (BR)					
<b>SC60A-30</b>	Soffit shoe support					
<b>SC60A-61</b>	Blade stop spacer					
<b>SC60A-62A</b>	Auxiliary shoe					
<b>SC60A-18</b>	Top jamb plate					
<b>SC60A-18PA</b>	PA Plate					
<b>SC60A-72</b>	Slim cover					

1. SC60A Series comes standard with less cover and all models have adjustable sizes 1-5.

### SC70A Series

		Cylinder	Cover	Arm	Finish	Accessories
<b>CYL</b>	Cast aluminum cylinder assembly (Default)					
<b>CYLDEL</b>	Delay action cylinder (N/A in Matte Black)					
<b>FPC</b>	Full plastic cover (Default)					
<b>SLIMPC</b>	Slim line plastic cover					
<b>RWPA</b>	Regular arm with parallel arm bracket					
<b>HWPA</b>	Hold open arm with parallel arm bracket					
<b>HDP A</b>	Heavy duty arm with parallel arm bracket					
<b>DS</b>	Dead stop arm					
<b>DSHO</b>	Dead stop hold open arm					
<b>SS</b>	Spring stop arm					
<b>SSHO</b>	Spring stop hold open arm					
<b>FA</b>	Forged arm					
<b>FAHO</b>	Forged arm with hold open					
<b>622</b>	Matte black (MTBLK)					
<b>689</b>	Aluminum (AL)					
<b>695</b>	Dark bronze (DKBRZ)					
<b>696</b>	Brass (BR) <sup>2</sup>					
<b>SC70A-30</b>	Soffit shoe support					
<b>SC70A-61</b>	Blade stop spacer					
<b>SC70A-62A</b>	Auxiliary shoe					
<b>SC70A-18</b>	Top jamb plate					
<b>SC70A-18PA</b>	PA Plate					
<b>SC70A-72</b>	Full cover					

2. Contact customer service at 1-877-671-7011 for lead time information.

3. SC71A models are adjustable sizes 1-6.



SC80A Series

		Cylinder	Cover	Arm	Finish	Accessories
<b>CYL</b>	Cast aluminum cylinder assembly (Default)					
<b>CYLDEL</b>	Delay action cylinder (N/A in Matte Black)					
<b>SLIMCOV</b>	Slim cover (Default)					
<b>FC</b>	Full cover					
<b>RWPA</b>	Regular arm with parallel arm bracket					
<b>HWPA</b>	Hold open arm with parallel arm bracket					
<b>HDPA</b>	Heavy duty arm with parallel arm bracket					
<b>DS</b>	Dead stop arm					
<b>DSHO</b>	Dead stop hold open arm					
<b>SS</b>	Spring stop arm					
<b>SSHO</b>	Spring stop hold open arm					
<b>622</b>	Matte black (MTBLK)					
<b>689</b>	Aluminum (AL)					
<b>695</b>	Dark bronze (DKBRZ)					
<b>696</b>	Brass (BR) <sup>1</sup>					
<b>SC80A-30</b>	Soffit shoe support					
<b>SC80A-61</b>	Blade stop spacer					
<b>SC80A-62A</b>	Auxiliary shoe					
<b>SC80A-18</b>	Top jamb plate					
<b>SC80A-18FC</b>	Top jamb plate - Full cover					
<b>SC80A-18PA</b>	PA Plate					
<b>SC80A-18PAFC</b>	PA Plate - Full cover					
<b>SC80A-72</b>	Slim cover					
<b>SC80A-72FC</b>	Full cover					

1. Contact customer service at 1-877-671-7011 for lead time information.
2. SC81A models are adjustable sizes 1-6.

SC90A Series

		Cylinder	Cover	Arm	Finish	Accessories
<b>CYL</b>	Cast aluminum cylinder assembly with adjustable backcheck (Default)					
<b>LBC</b>	Cast aluminum cylinder assembly with less backcheck					
<b>LESSCOV</b>	Less cover (Default)					
<b>SC91A</b>	1					
<b>SC93A</b>	3					
<b>SC94A</b>	4					
<b>STD</b>	Standard cover (SC93 and SC94 only)					
<b>RWPA</b>	Regular arm with parallel arm bracket					
<b>HWPA</b>	Hold open arm with parallel arm bracket					
<b>622</b>	Matte black (MTBLK)					
<b>689</b>	Aluminum (AL)					
<b>695</b>	Dark bronze (DKBRZ)					
<b>SC90A-18</b>	Mounting plate - Top jamb					
<b>SC90A-18PA</b>	Mounting plate - Push side					
<b>043156654352</b>	SC90 Pinion cap 689					
<b>043156654369</b>	SC90 Pinion cap 695					

HOW TO ORDER OVERHEAD STOPS AND HOLDERS ■ GLYNN-JOHNSON

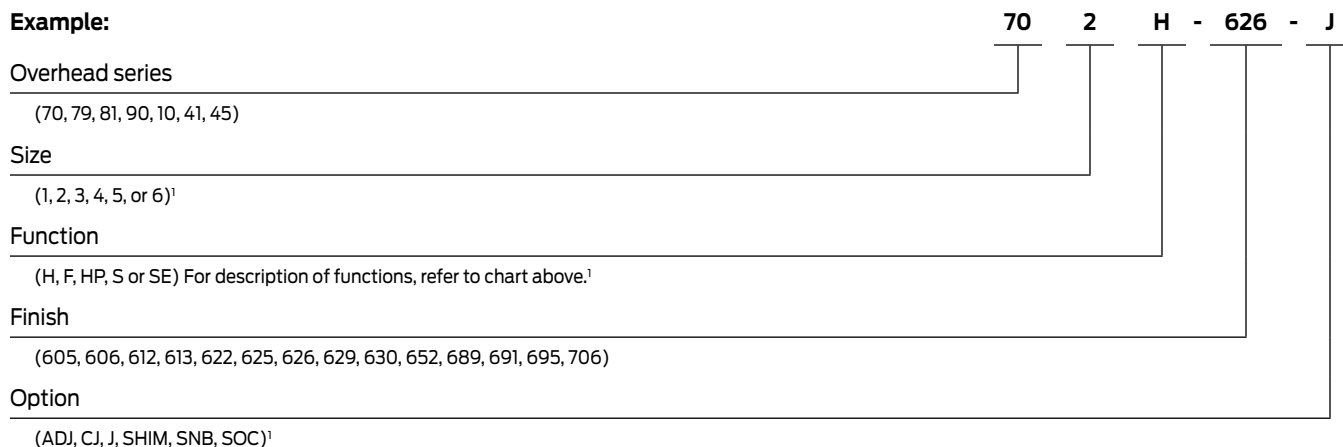

<sup>1</sup> Please refer to individual Overhead Series price book pages for availability of finish, size, function, and options.

SCHLAGE LOCKS

COMMERCIAL WIRELESS ELECTRONIC

COMMERCIAL MECHANICAL

EXIT DEVICES

DOOR CLOSERS

**ACCESSORIES**



this page intentionally blank

## About Allegion

Allegion (NYSE: ALLE) is a global pioneer in seamless access. We keep people and their assets safe, wherever they are, bringing together simple solutions, convenient access and advanced technology.

For more, visit [www.allegion.com](http://www.allegion.com)

KRYPTONITE ■ LCN ■  ■ STEELCRAFT ■ VON DUPRIN