



# SC80A Series/Serie/Série

# FALCON®

44135

Heavy Duty Arm Models, SC81A (1-6 Adj.)  
Modelos con brazo para uso industrial, SC81A (1-6 Adj.)  
Modèles avec bras à usage industriel, SC81A (1-6 adj)

Installation Instructions  
Instrucciones de Instalación  
Instructions d'installation

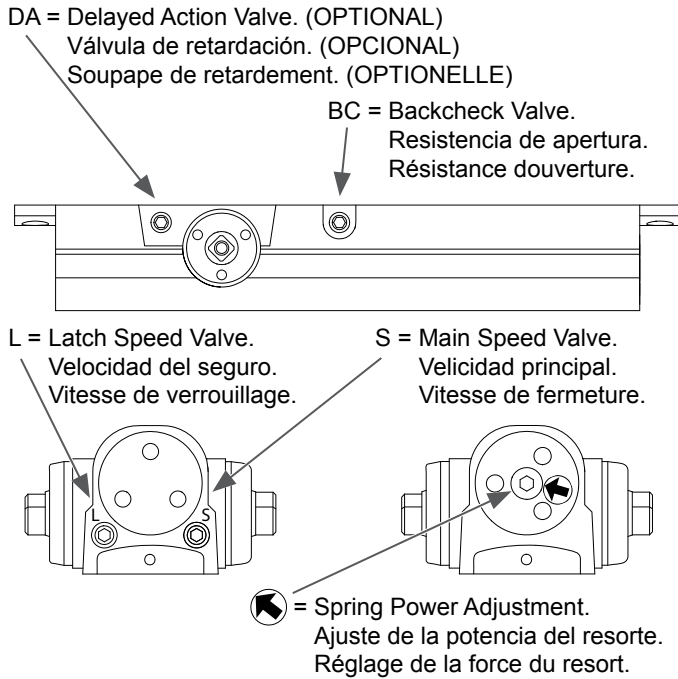

### Parallel Arm Installation Instalación "brazo paralelo" Installation "bras parallèle"

Closer mounted on the push side of the door (opposite of the hinge side).

Cerrador montado al lado del empuje de la puerta (opuesto al lado del gozne).

Ferme-porte installé sur le côté à pousser de la porte (à l'opposé du côté de la charnière)

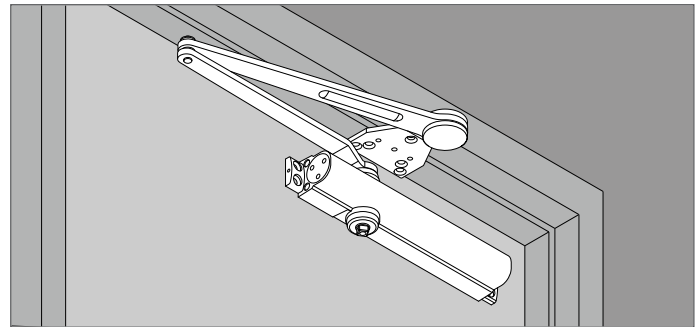

### ⚠ CAUTION ⚠

Improper installation or regulation may result in personal injury or property damage. Follow all instructions carefully. For questions, call Falcon at: 1-877-671-7011

### ⚠ ADVERTENCIA ⚠

Una instalación o un ajuste incorrectos pueden resultar en daño personal o material. Siga bien todas las instrucciones. Para más informaciones, llama a Falcon al: 1-877-671-7011

### ⚠ DANGER ⚠

Une installation ou un réglage inadéquats peuvent entraîner des blessures ou des dommages. Veuillez suivre toutes les instructions avec soin. Pour plus de renseignements, composez le: 1-877-671-7011

	Fasteners	Door Frame	Drill Sizes
Arm	#14 Wood	Wood	1/8"
	1/4-20 Machine	Metal	Drill: #7 Tap: 1/4-20
Closer Body	#14 Wood	Wood	1/8"
	1/4-20 Machine	Metal	Drill: #7 Tap: 1/4-20
Either	Self-Reaming, & Tapping (SRT)	Metal	1/8"
Fifth Hole Spacer	#14 Wood	Wood	1/8"
	1/4-20 Machine	Metal	Drill: #7 Tap: 1/4-20
	Self-Reaming, & Tapping (SRT)	Metal	1/8"

### Customer Service

1-877-671-7011

www.allegion.com/us



© Allegion 2016  
Printed in U.S.A.  
44135 Rev. 10/16-a

**1** Door and Frame Preparation.  
Preparación de la puerta y del cuadro.  
Préparation de la porte et du cadre.

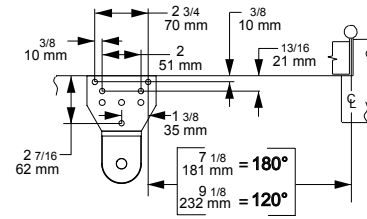
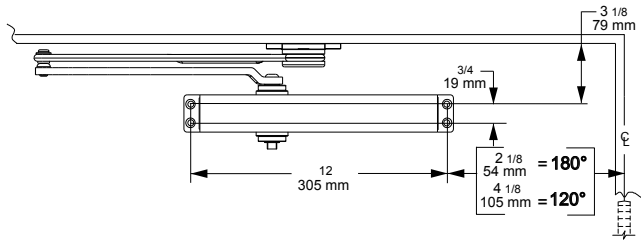

Right hand door illustrated. Same dimensions apply for left hand door measured from hinge side.

Montaje de puerta a la derecha como ilustrado. Las mismas dimensiones se aplican para un montaje de puerta a la izquierda medidas a partir del lado del gozne.

Porte main droite illustrée. Les mêmes dimensions s'appliquent pour une porte main gauche mesurées à partir du côté de la charnière.

**2** Determine door width, adjust spring power to match chart.  
Determina la anchura de la puerta. Ajuste la potencia del resorte según lo indicado en el gráfico.  
Mesurez la largeur de la porte. Réglez le ressort selon les indications du tableau.

	POWER ADJUSTMENT AJUSTE DE POTENCIA REGLER LA PUISSANCE
	<b>SC81A (1-6)</b>
	-5
32" - 813 mm	-3
36" - 914 mm	0
42" - 1067 mm	+5
48" - 1219 mm	+10
54" - 1372 mm	+15

**3** Disconnect arm & shoe assembly from main arm.  
Desconecte el ensamblaje del brazo y de la zapata del brazo principal.  
Séparez l'assemblage du bras et de la console du bras principal.

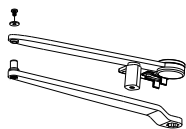

**4** Install arm & shoe assembly onto frame.  
Instale el ensamblaje del brazo y de la zapata en el cuadro.  
Installez l'assemblage du bras et de la console sur le cadre.

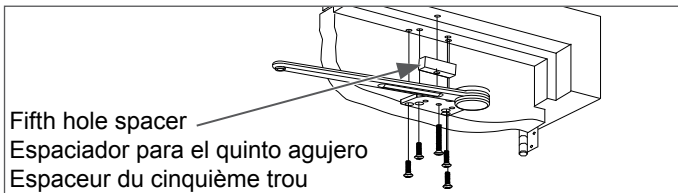

**5** Install closer onto door.  
Monte el cerrador en la puerta.  
Installez le ferme-porte sur la porte.

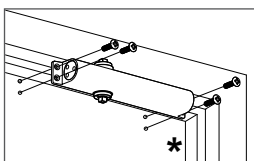

- \* Spring power faces toward the hinge edge.
- \* Potencia del resorte cara hacia el borde del gozne.
- \* Force du ressort fait face vers le bord de la charnière.

**6** Attach main arm to closer.  
Coloque el brazo principal al cerrador.  
Attachez le bras principal au ferme-porte.

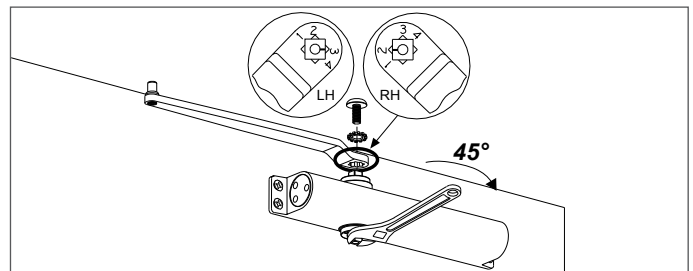

**7** Connect arm pieces.  
Conecte las partes del brazo.  
Réunissez les sections de bras.

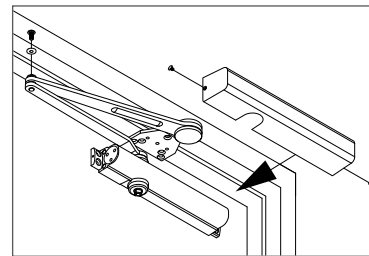

Screw cap onto shaft and install cover (cap not used with full cover).  
Atornille la tapa en el eje e instale la cubierta (no se usa la tapita con la tapa completa).  
Tournez le capuchon sur l'arbre et installez le couvercle (le capuchon nest pas utilisé avec le couvercle complet).

**8** Adjustment Instructions.  
Instrucciones de ajuste.  
Instructions de réglage.

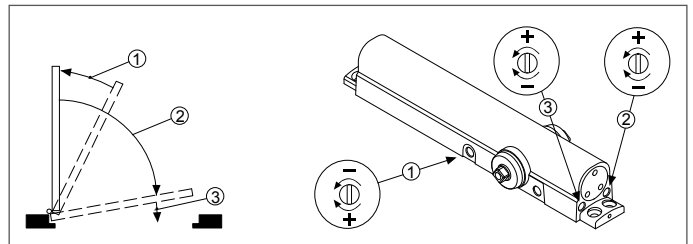

Optional Delay Action

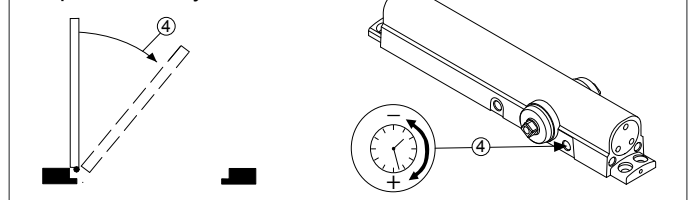

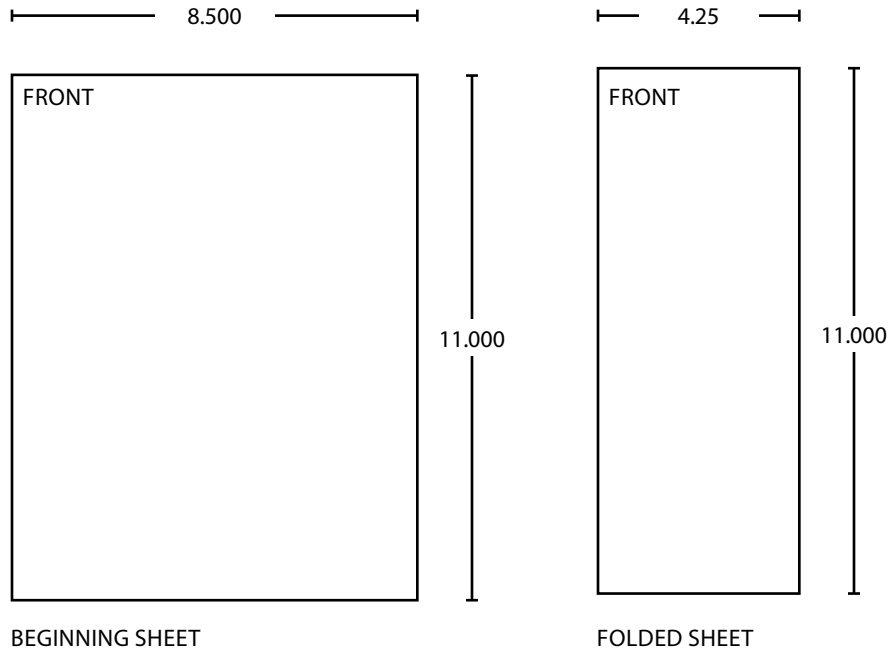

Additional Notes:
1. None

Revision History						Revision Description:					
A	B	C	D	E	F	N/A					
xxxxx											
Material						Edited By		Approved By		EC Number	Release Date
White Paper						N. Wilson		M. Roberts		xxxxx	10-31-16
Notes 1. printed two sides 2. printed black 3. tolerance ± .13 4. printed in country may vary 5. drawings not to scale						Title					
						SC80 Series Heavy Duty Arms Instruction Sheet					
						Creation Date		Number			Revision
						08-08-2016		44135			A
						Created By		Activity		© Allegion 2016	
						N. Wilson		3899 Hancock Expwy Security, CO 80911			
						Software: InDesign CS6					