



L-Series Door Template Index

Functions	Rose Trim		Escutcheon Trim		HSLR Trim	
	Wood	Metal	Wood	Metal	Wood	Metal
L/LV/LM/LMV 9000 Series Lock Case Dimensions	L1					
L400 Series Lock Case Dimensions	L2					
LM9200 Lock Case Dimensions	L3					
L9000 Series HSLR Lock Case Dimensions	-				L4	
L9010, L9110	L892	L893	L898	L899	L965	L966
LM9310		L893		L899	-	-
L9025	L808	L809	L810	L811	-	-
L9026	L812	L813	L814	L815	-	-
L/LV9040, L/LV9044, L/LV9440, L/LV9444	L894	L895	L900	L901	L965	L966
L0170	L739	L781	L741	L782	-	-
L0172	L743	L744	L745	L746	-	-
L9175	L851	L806	L859	L855	-	-
LM9325		L806		L855	-	-
L9176	L852	L807	L860	L856	-	-
L/LV/LM/LMV9050, L/LV/LM/LMV9056, L/LV9453, L/LV9456, L9473, L/LV9480, L/LV9485	L896	L897	L826	L827	L965	L966
LM/LMV9350, LM/LMV9356		L897		L827	-	-
L/LV9060, L/LV/LM/LMV9071, L/LV9077, L/LV9082 EL/EU, L/LV9457, L/LV9458, L9466, L/LV9482	L816	L817	L828	L829	L965	L966
LM/LMV9371		L817		L829	-	-
L/LV9070, L/LV9076, L/LV9080, L/LV9080 EL/EU, L9465	L905	L906	L907	L908	L965	L966
LM/LMV9370, LM/LMV9380		L906		L908	-	-
L/LV9486, L/LV9496	L820	L821	-	-	-	-
L9460, L9462, L9463, L9464 (Deadbolt only)	L902	L903			-	-
L9412	L967	L968	L911	L912	-	-
L460, L462, L463, L464, L480, L496 (Deadbolt, small chassis)	L909	L910	-	-	-	-
Mounting active trim, one side, L283-150 (use with appropriate lock function template)	L904		-	-	-	-
L9090, L9091	L918	L916	L917	L915	-	-
L9092, L9093	L922	L920	L921	L919	L965	L966
L9094, L9095, L9494, L9495	L926	L924	L925	L923	L965	L966
L9492, L9493	L961	L962	L963	L964	L965	L966
LM9210, LM9210F, LM9210M	L928	L944	L927	L943	-	-
LM9225, LM9225F, LM9225M	L930	L946			-	-
LM9250, LM9250F, LM9250M, LM9256, LM9256F, LM9256M	L932	L948	L931	L947	-	-
LM9270, LM9270F, LM9270M, LM9280, LM9280F, LM9280M	L934	L950	L933	L949	-	-
LM9271, LM9271F, LM9271M	L936	L952	L935	L951	-	-
LM9290 EL/EU, LM9290F EL/EU, LM9290M EL/EU, LM9291 EL/EU, LM9291F EL/EU, LM9291M EL/EU	L938	L954	L937	L953	-	-
LM9292 EL/EU, LM9292F EL/EU, LM9292M EL/EU, LM9293 EL/EU, LM9293F EL/EU, LM9293M EL/EU	L940	L956	L939	L955	-	-
LM9294 EL/EU, LM9294F EL/EU, LM9294M EL/EU, LM9295 EL/EU, LM9295F EL/EU, LM9295M EL/EU	L942	L958	L941	L957	-	-
LM9200 LBL (less bottom latch)	L959	L960	L959	L960	-	-

Dimensions shown in parentheses () are in millimeters.

© 2021 Allegion
L1 Rev. 12/21

DRAWING IS NOT TO SCALE!
Customer service: 877-671-7011
We can help you find the correct guide
for

Door preparation template

L1



L400-Series

Lock Case Dimensions



Case Size:	47/16" x 35/8" x 1" (113 mm x 92 mm x 25 mm)	Knob or Lever to Turn Piece:	19/64" (29 mm)
Backset:	2 3/4" (70 mm)	Height Line to Center of Deadbolt:	1 13/16" (46 mm)
Door Range:	1 3/4" – 3" (44 mm – 76 mm)		
Lock Front:	1 1/4" x 5 19/32" x 7/32" (32 mm x 142 mm x 6 mm)		

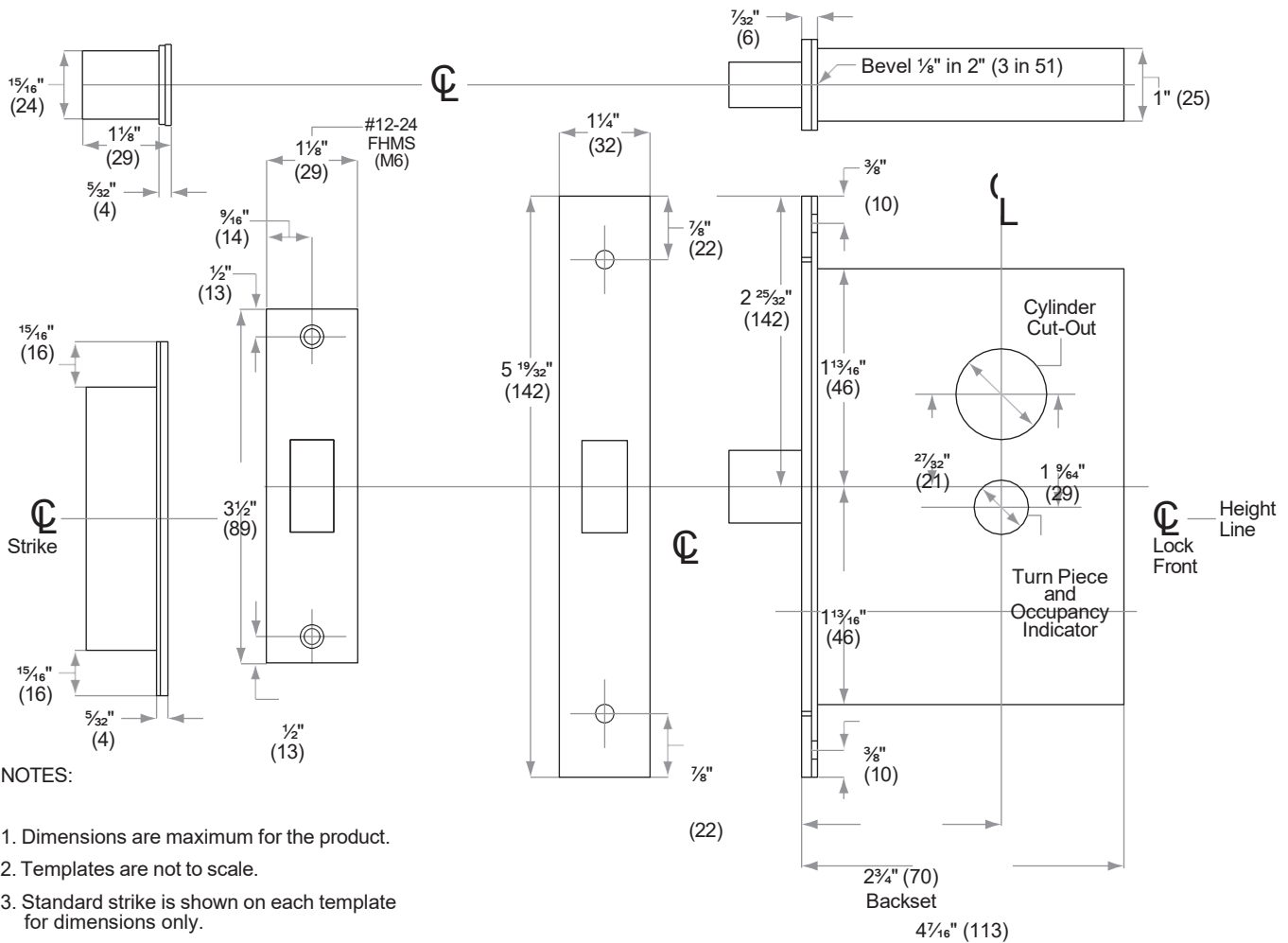

NOTES:

1. Dimensions are maximum for the product.
2. Templates are not to scale.
3. Standard strike is shown on each template for dimensions only.
4. Dimensions do not provide allowances for door silencers, weather stripping, sound proofing or other additions to door or door frames.

ANSI Standards: L400-Series locks meet all requirements for installations in doors and frames prepared in accordance with ANSI specifications A156.13, 2010.

Metal Doors: Suitable reinforcement is required to support lock case in center of door and to prevent door from compressing when trim is tightened. (See ANSI A115.1)

Thick Doors: Locks for non-standard door thickness may require special instructions.

Lead Lining: When L900-Series or L400-Series locks are ordered with lead lining, add 1/8" (3) to the width of the mortise cut-out on the lock case cover side of installation.

**DRAWING IS NOT TO
SCALE!**

**Customer service: 877-
671-7011**

**We can help you find the
correct guide for**

Door preparation template

L2

LM9200-Series

Lock Case Dimensions

ALLEGION™

Case Size:	429/64" x 1219/32" x 1" (113 mm x 319 mm x 25 mm)
Backset:	2 3/4" (70 mm)
Door Range:	1 3/4" – 2 1/2" (44 mm – 64 mm)
Lock Front:	1 1/4" x 157/8" x 3/32" (32 mm x 403 mm x 2 mm)
Lever to Cylinder:	355/64" (98 mm)
Lever to Turn Piece:	223/32" (69 mm)

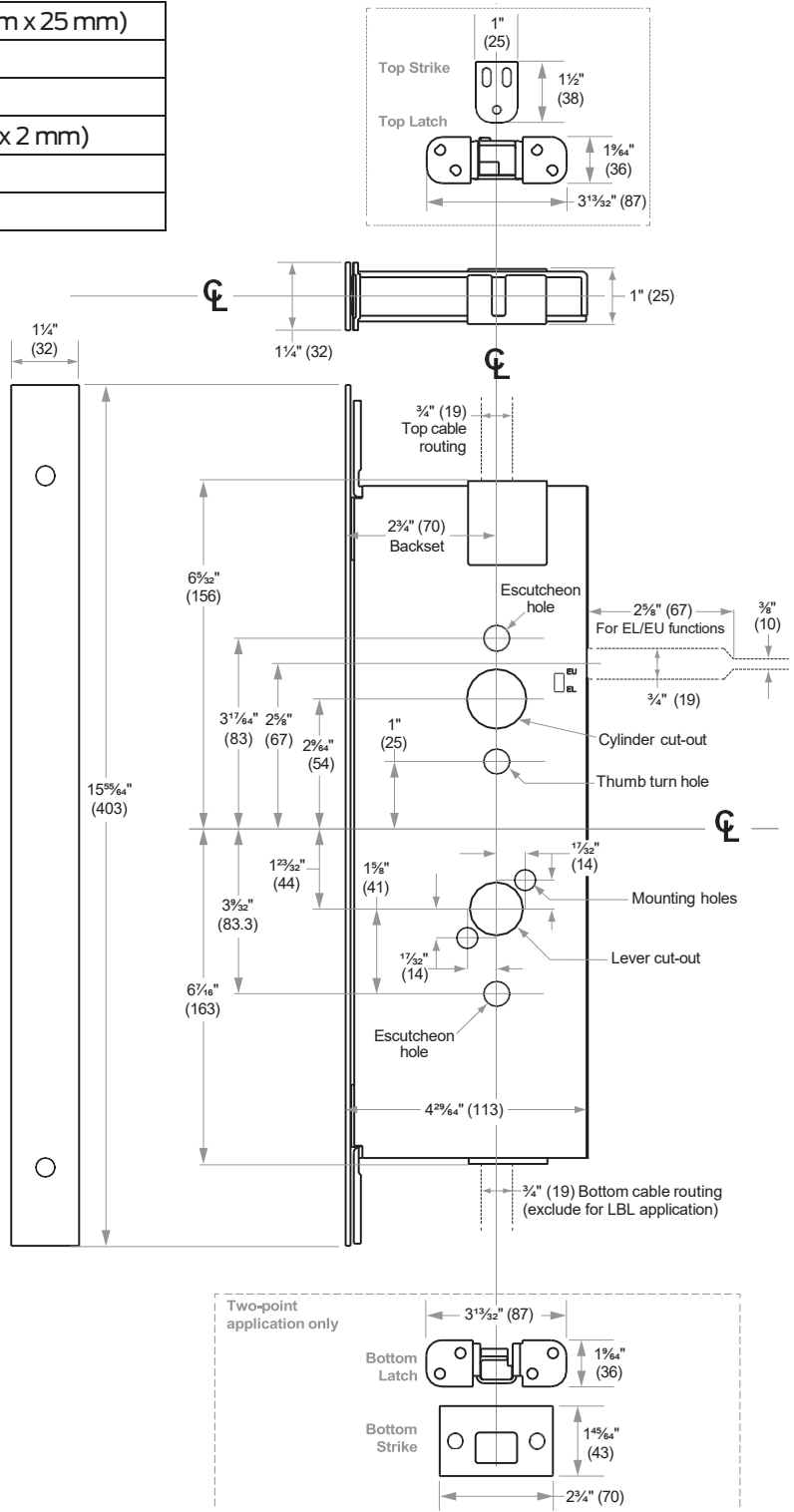

NOTES:

1. Dimensions are maximum for the product.
2. Templates are not to scale.
3. Dimensions do not provide allowances for door silencers, weather stripping, sound proofing or other additions to door or door frames.

ANSI Standards:

LM9200-Series locks meet all requirements for installations in doors and frames prepared in accordance with ANSI specifications A 156.37, 2014.

Electrified Locks:

Provisions must be made to route low voltage wire to the lock. Power transfer unit and low voltage wiring are not furnished.

Dimensions shown in parentheses () are in millimeters.

© 2021 Allegion
L3 Rev. 12/21

DRAWING IS NOT TO SCALE!
Customer service: 877-671-7011
We can help you find the correct guide

for

Door preparation
template

L3

L9000-Series HSLR

Lock Dimensions

ALLEGION™

Case Size:	Standard: 4 7/16" x 6 1/16" x 1" (113 mm x 154 mm x 25 mm) EL/EU: 4 3/4" x 6 1/16" x 1" (121 mm x 154 mm x 25 mm)
Backset:	2 3/4" (70 mm)
Door Range:	1 3/4" (44 mm)
Lock Front:	1 1/4" x 8" x 3/32" (32 mm x 203 mm x 2 mm)

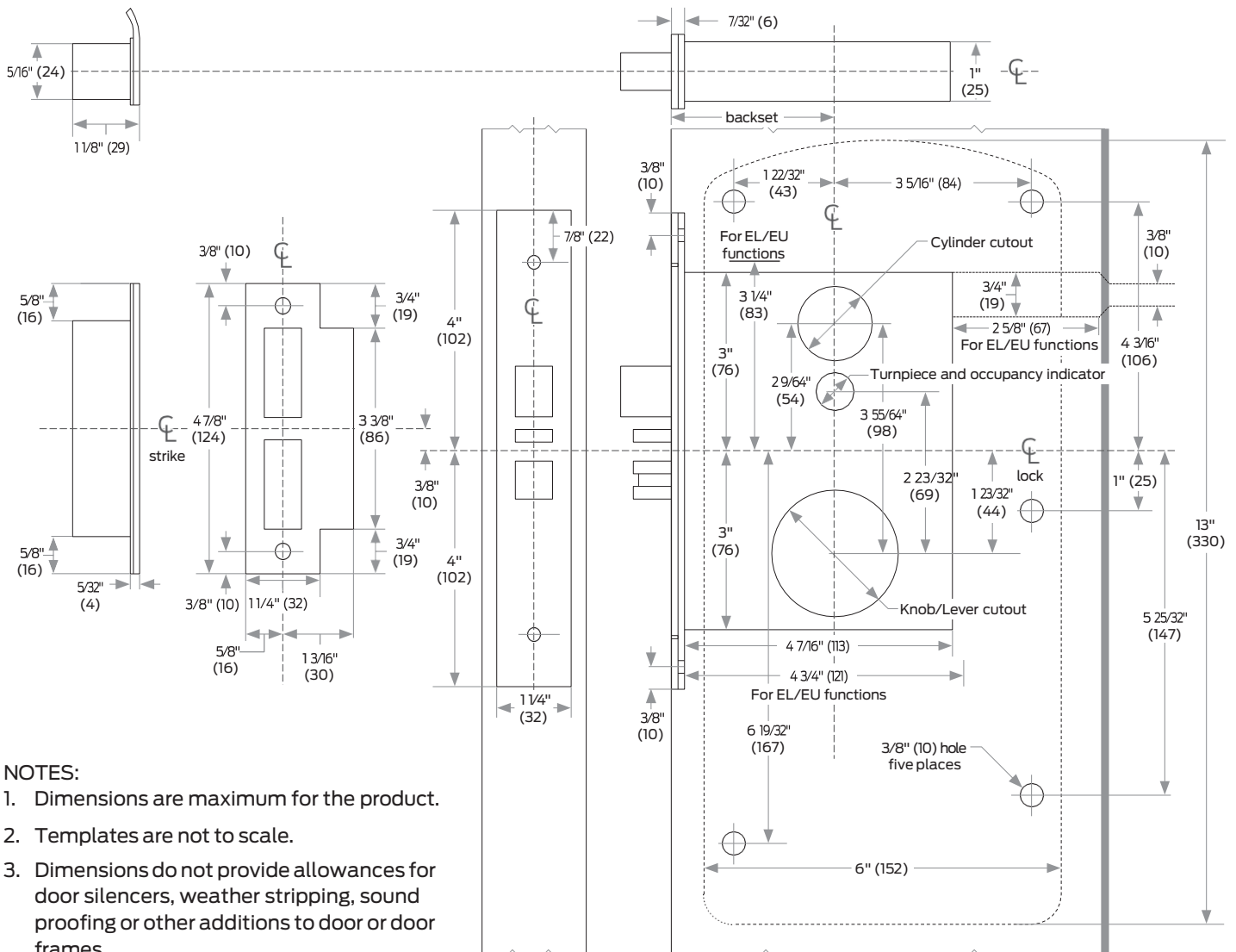

NOTES:

1. Dimensions are maximum for the product.
2. Templates are not to scale.
3. Dimensions do not provide allowances for door silencers, weather stripping, sound proofing or other additions to door or door frames.

Dimensions shown in parentheses () are in millimeters.

© 2021 Allegion
L4 Rev. 06/20

DRAWING IS NOT TO SCALE!
Customer service: 877-671-7011
We can help you find the correct guide

for

Door preparation
template

L4

L/LV/LM/LMV-Series

Model L0170

ALLEGION™

Door Type: Wood or composite, flat
Trim: Rose

Trim is mounted on one side only

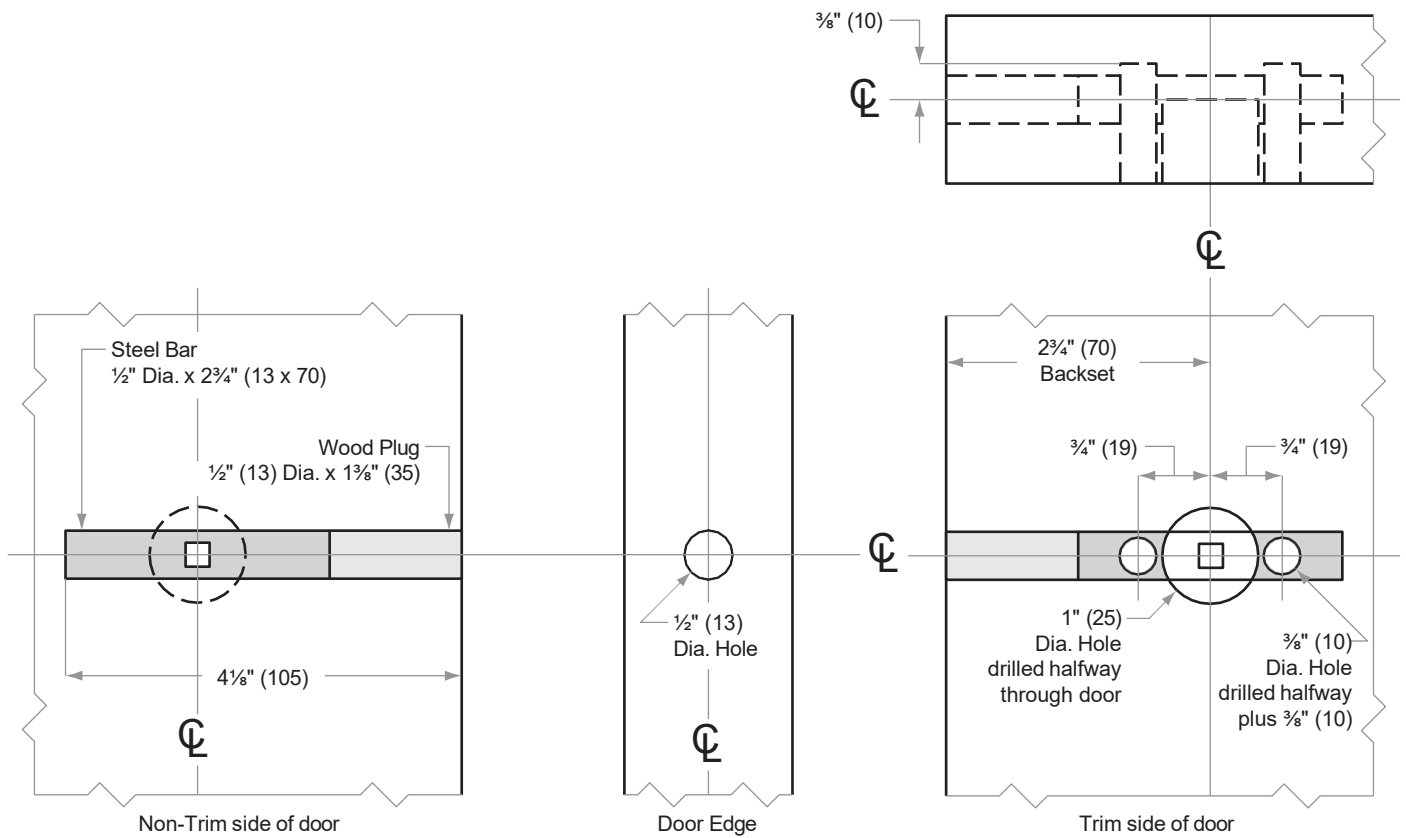

Dimensions shown in parentheses () are in millimeters.

L739 Rev. 12/21

© 2021 Allegion

DRAWING IS NOT TO SCALE!
Customer service: 877-671-7011

**We can help you find the
correct guide for**

Door preparation template

L739

L/LV/LM/LMV-Series

Model L0170

ALLEGION™

Door Type: Wood or composite, flat
Trim: N Escutcheon
Notes: Not to be used with L Escutcheon

Trim is mounted on one side only

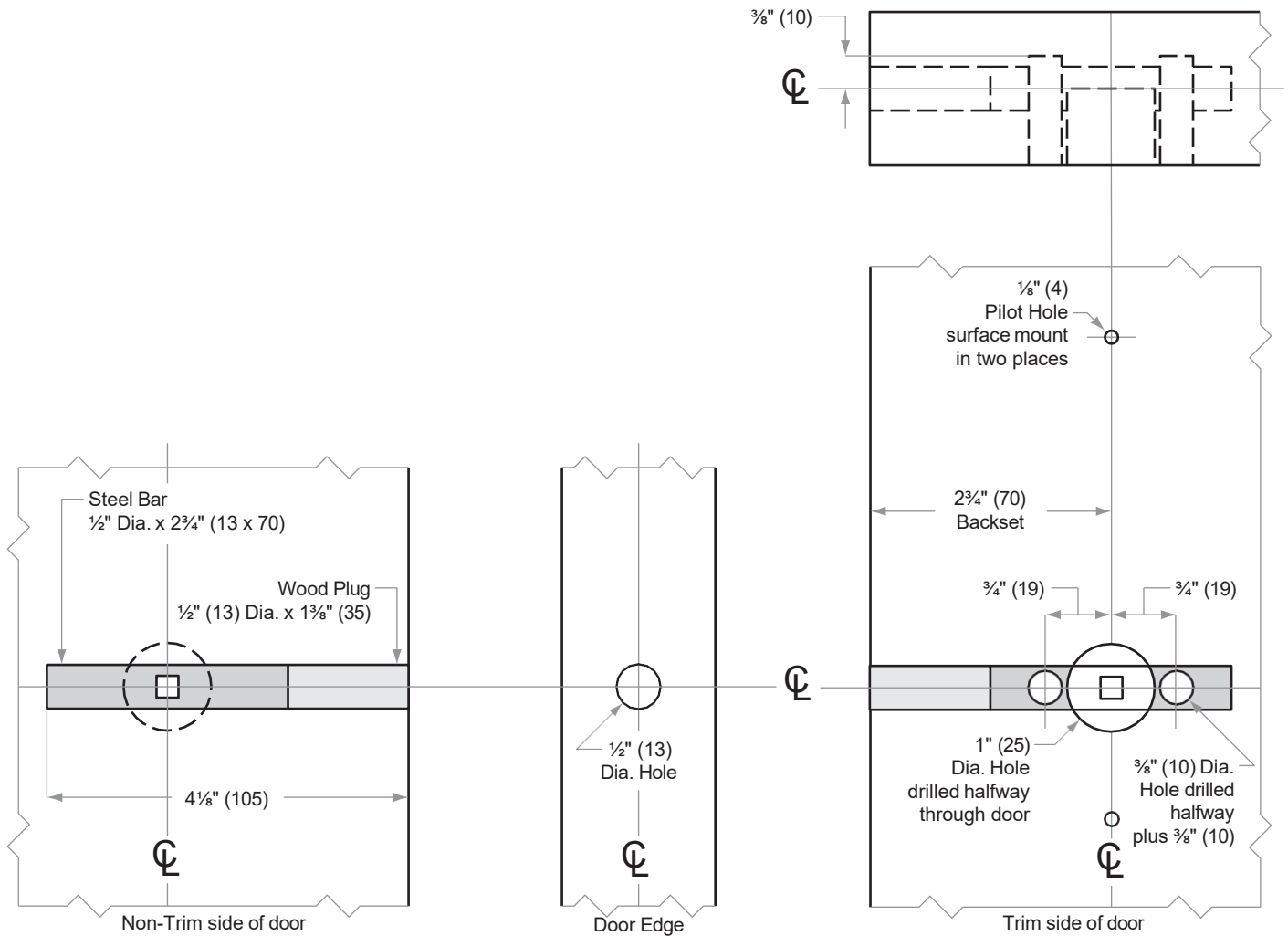

Dimensions shown in parentheses () are in millimeters.

DRAWING IS NOT TO SCALE!

Customer service: 877-671-7011

Door preparation
template



L/LV/LM/LMV-Series Model L0172

Door Type: Wood or composite, flat
Trim: Rose

Left Hand (LH) door shown

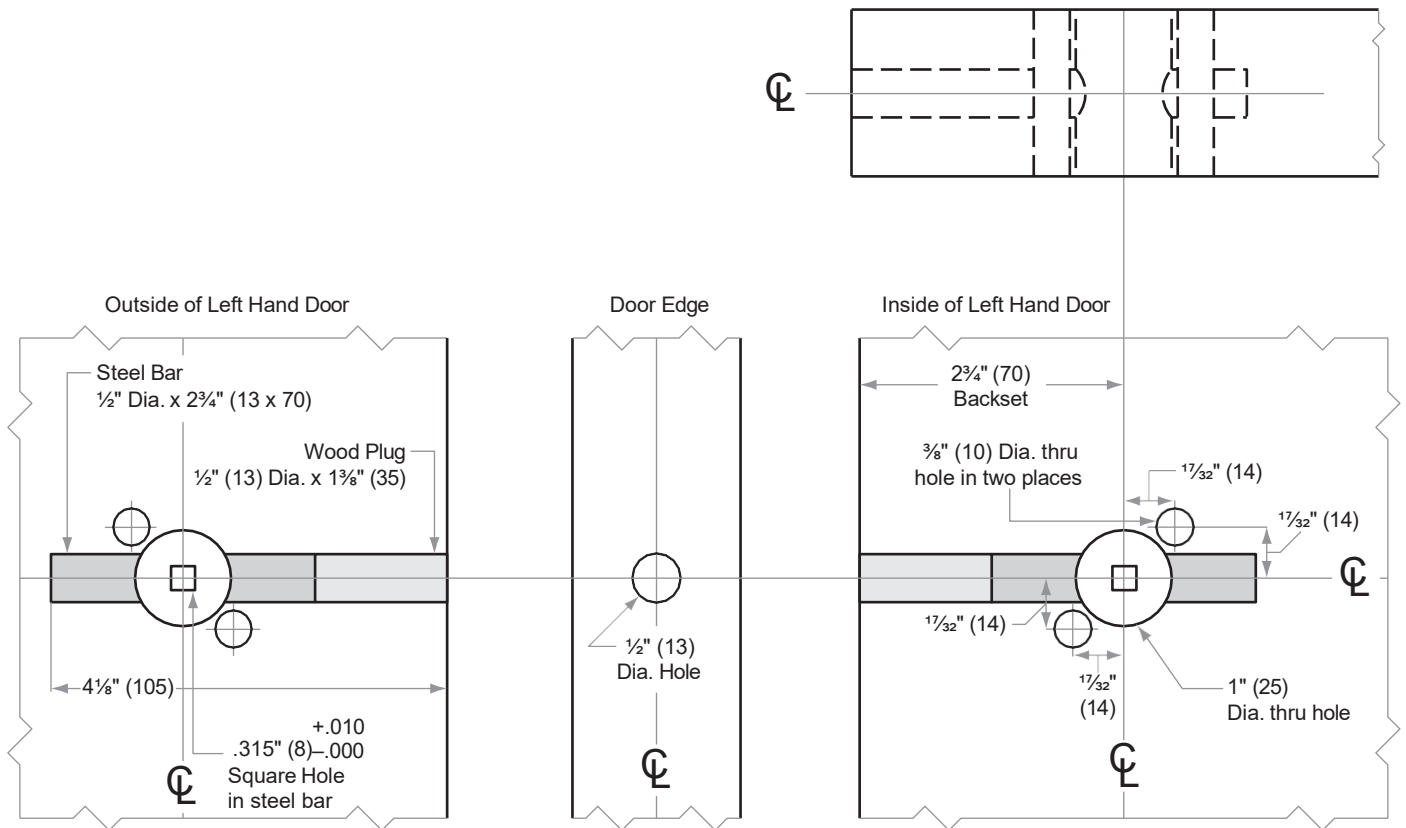

Dimensions shown in parentheses () are in millimeters.

DRAWING IS NOT TO SCALE!
Customer service: 877-671-

7011

Door preparation
template

L/LV/LM/LMV-Series

Model L0172

ALLEGION™

Door Type: Metal, flat or beveled
 Trim: Rose

IMPORTANT! Suitable reinforcement required for metal door installation

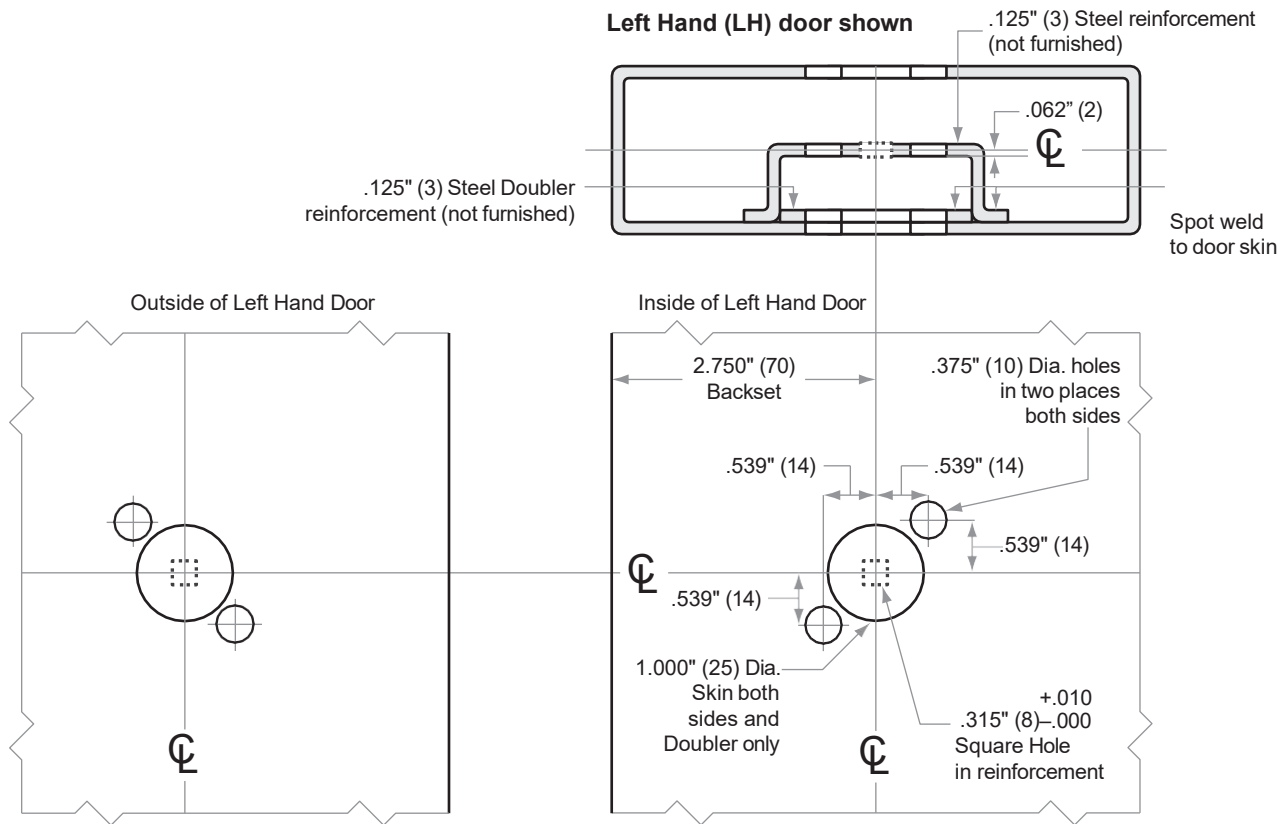

Dimensions shown in parentheses () are in millimeters.

DRAWING IS NOT TO SCALE!

Customer service: 877-671-7011

Door preparation
template

Door preparation
template

L/LV/LM/LMV-Series

Model L0172

ALLEGION™

Door Type: Metal, flat or beveled
 Trim: Escutcheon

IMPORTANT! Suitable reinforcement required for metal door installation

Left Hand (LH) door shown

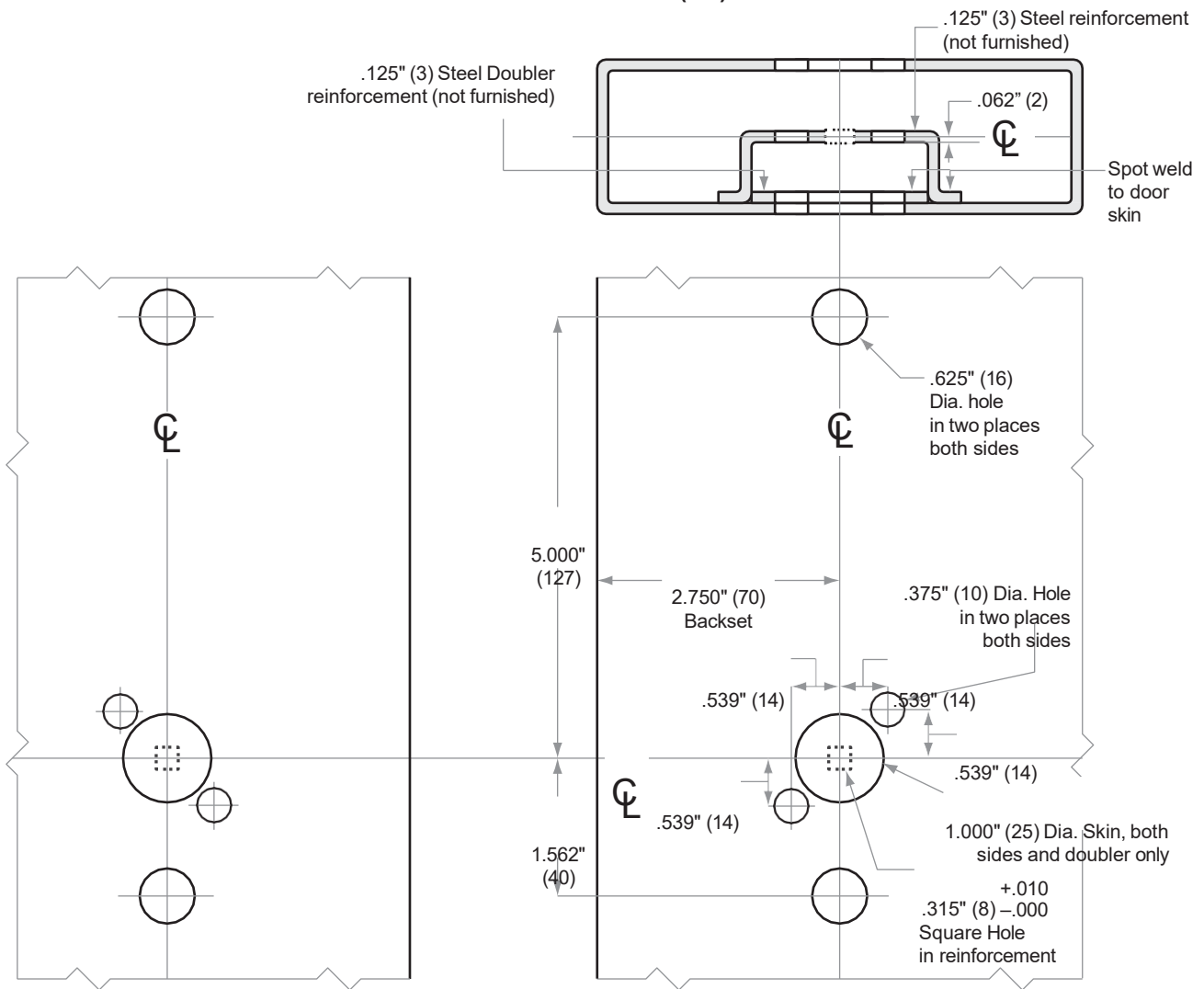

Dimensions shown in

parentheses () are in millimeters.

DRAWING IS NOT TO SCALE!

Customer service: 877-671-7011

Door preparation
template

L/LV/LM/LMV-Series

Model L0170

ALLEGION™

Door Type: Metal, flat or beveled
 Trim: Rose

IMPORTANT! Suitable reinforcement required for metal door installation

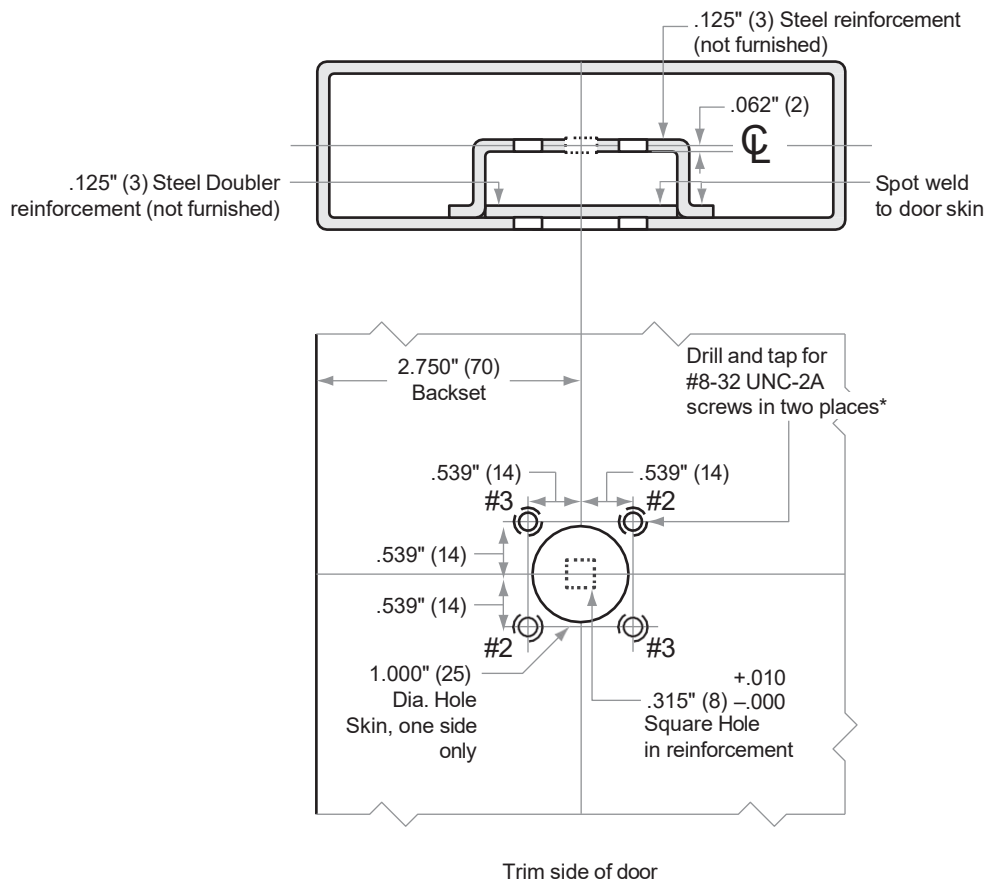

*** Drill and tap two holes at locations #2 for outside RH/RHR or inside LH/LHR doors or Drill and tap two holes at locations #3 for outside LH/LHR or inside RH/RHR doors**

Dimensions shown in parentheses () are in millimeters.

L781 Rev. 12/21

DRAWING IS NOT TO SCALE!
Customer service: 877-671-7011

© 2021 Allegion

**We can help you find the
correct guide for**

Door preparation template

L781

L/LV/LM/LMV-Series

Model L0170

ALLEGION™

Door Type: Metal, flat or beveled
 Trim: Escutcheon

IMPORTANT! Suitable reinforcement required for metal door installation

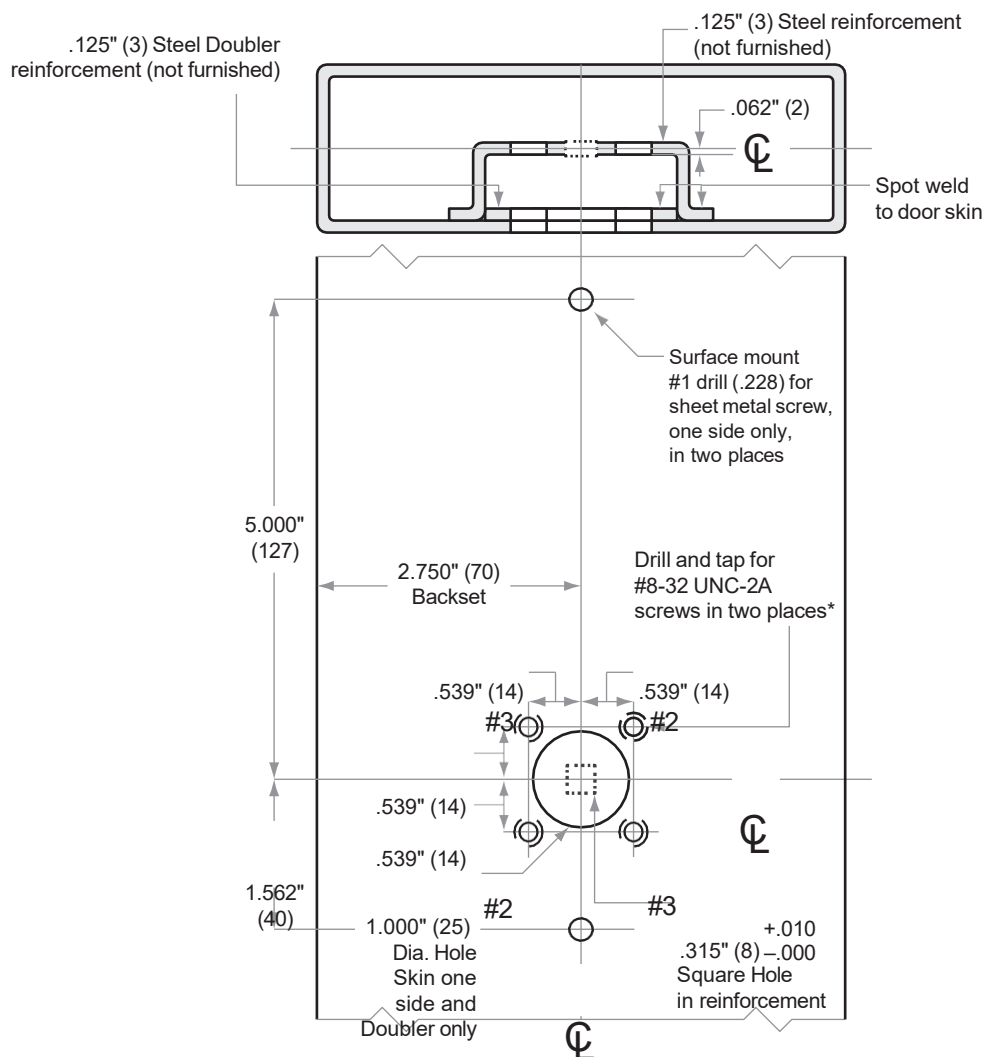

***Drill two holes at locations #2 for outside RH/RHR or
 Drill two holes at locations #3 for outside LH/LHR**

DRAWING IS NOT TO SCALE!
Customer service: 877-671-7011
We can help you find the correct guide
for

Door preparation template

L782

L/LV/LM/LMV-Series

Model L9175, LM9325

ALLEGION™

Door Type: Metal, flat or beveled
 Trim: Rose

For Case and Strike dimensions, see Template L1

Left Hand (LH) Door Shown

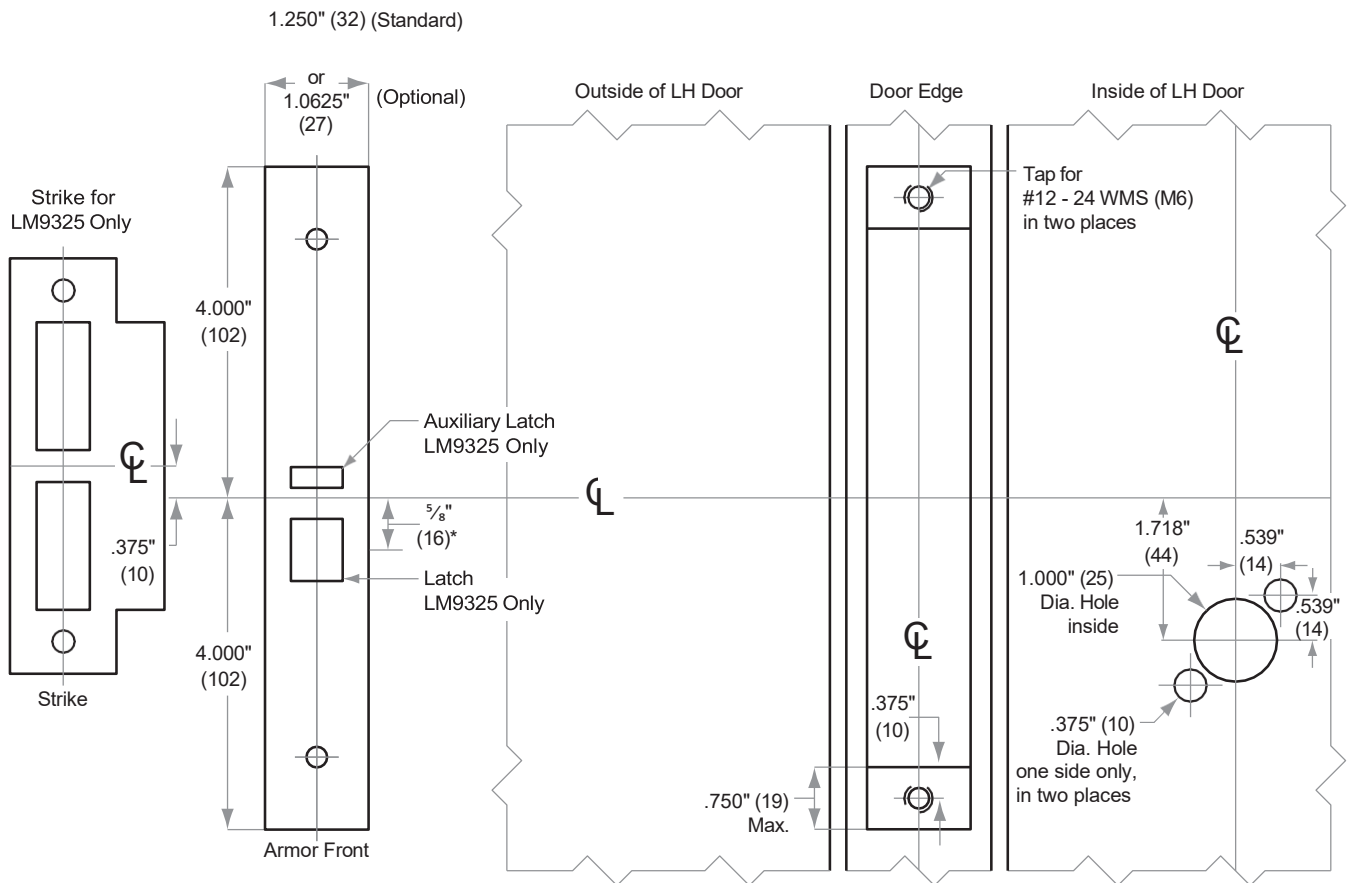

* Centerline of Armor Front to Centerline of Latch dimension

Dimensions shown in parentheses () are in millimeters.

DRAWING IS NOT TO SCALE!

Customer service: 877-671-7011

Door preparation
template

L/LV/LM/LMV-Series

Model L9176

ALLEGION™

Door Type: Metal, flat or beveled
Trim: Rose

For Case and Strike dimensions, see Template L1

Left Hand (LH) Door Shown

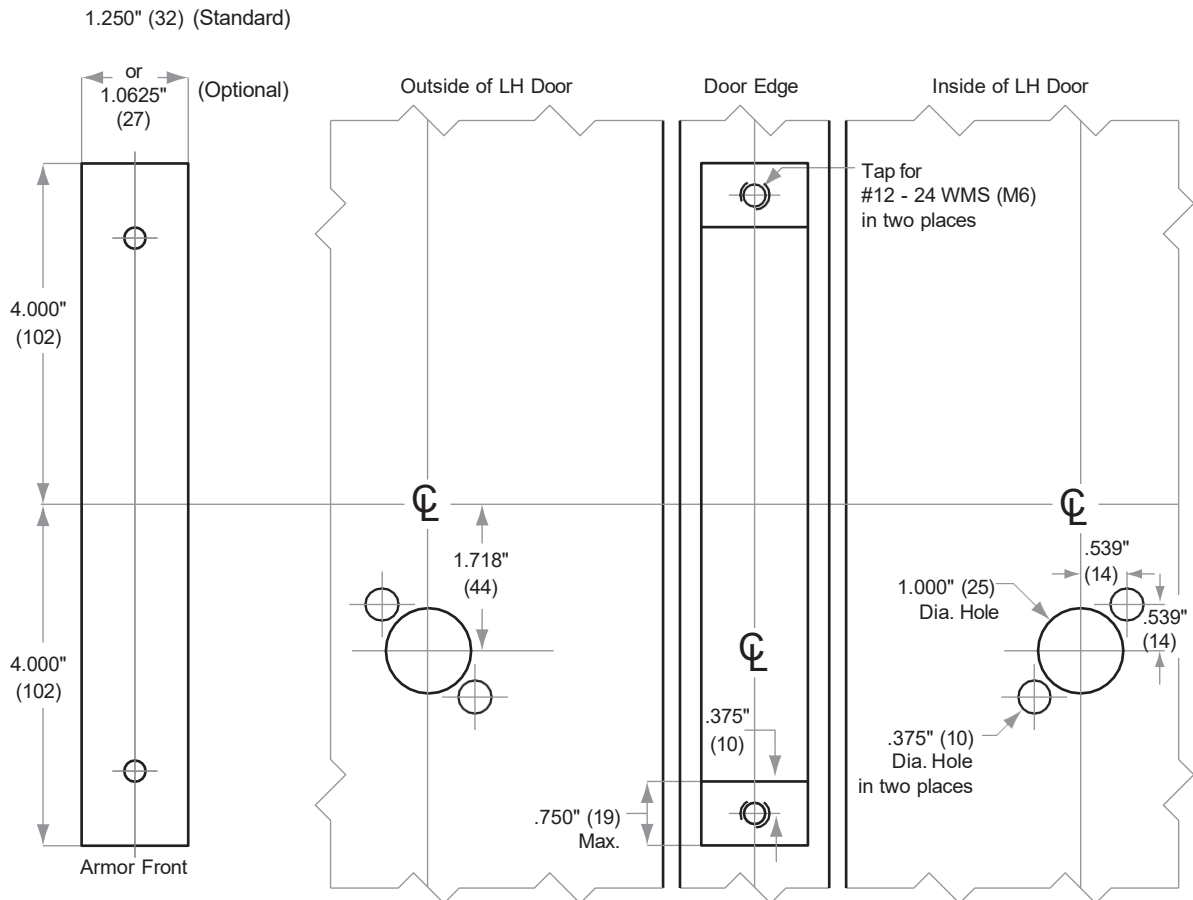

Dimensions shown in parentheses () are in millimeters.

DRAWING IS NOT TO SCALE!

Customer service: 877-671-7011

Door preparation
template

L/LV/LM/LMV-Series

Model L9025

ALLEGION™

Door Type: Wood or composite, flat
 Trim: Rose

For Case dimensions see Template L1

Left Hand (LH) Door Shown

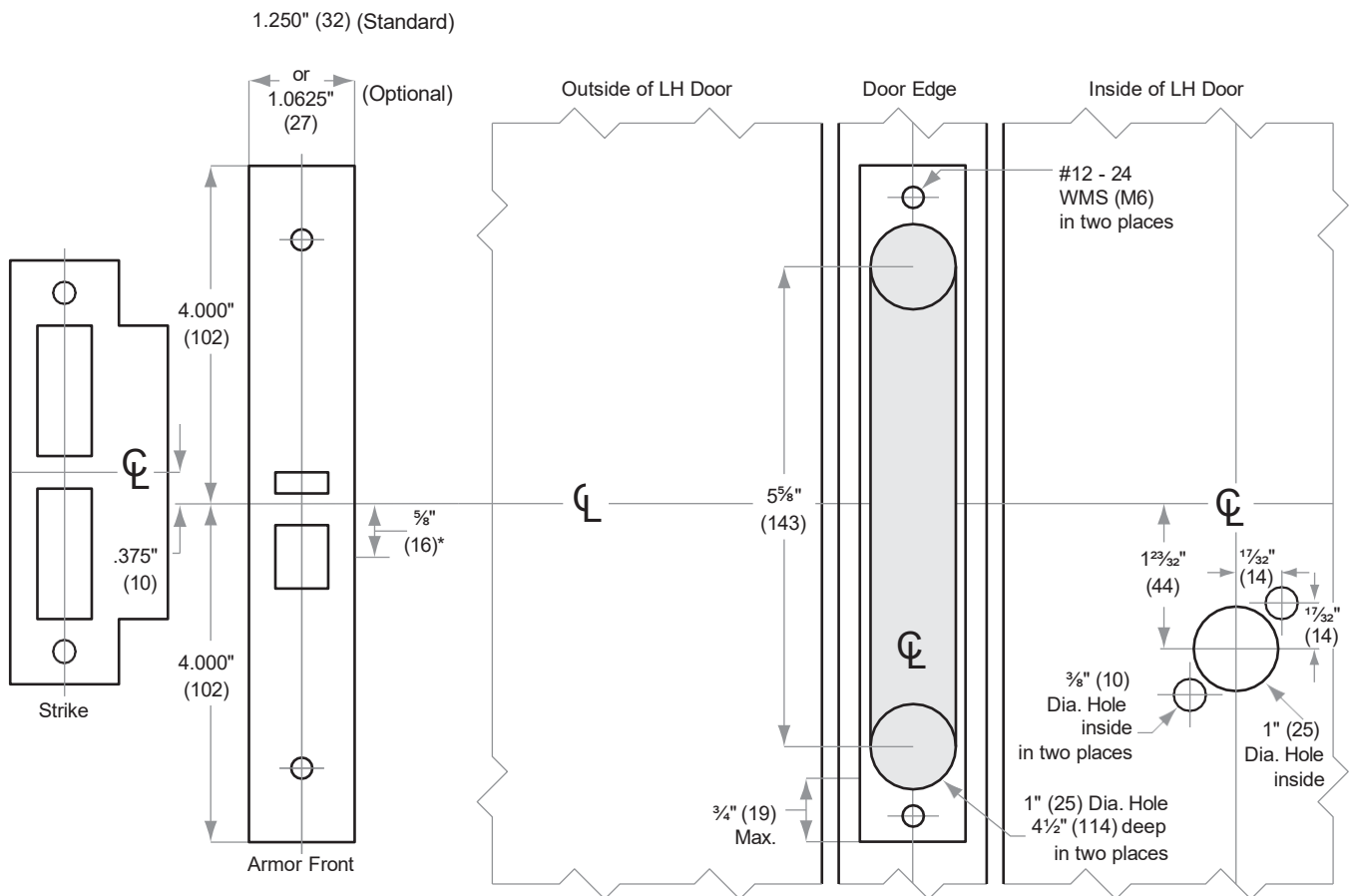

* Centerline of Armor Front to Centerline of Latch dimension

Dimensions shown in parentheses () are in millimeters.

DRAWING IS NOT TO SCALE!

Customer service: 877-671-7011

Door preparation
template

L/LV/LM/LMV-Series

Model L9025

ALLEGION™

Door Type: Metal, flat or beveled
 Trim: Rose

For Case and Strike dimensions, see Template L1

Left Hand (LH) Door Shown

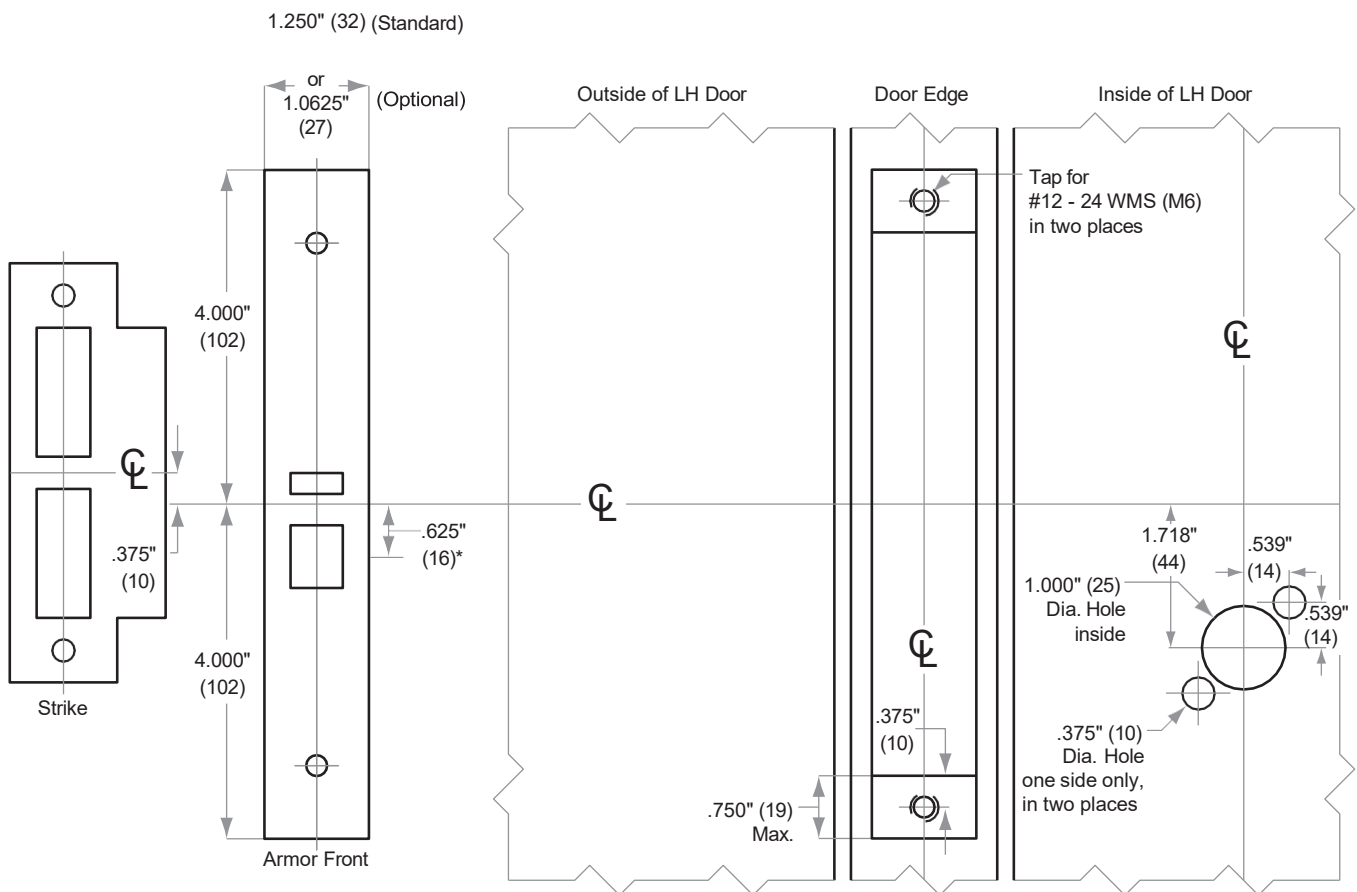

* Centerline of Armor Front to Centerline of Latch dimension

Dimensions shown in parentheses () are in millimeters.

L809 Rev. 12/21

© 2021 Allegion

DRAWING IS NOT TO SCALE!
Customer service: 877-671-7011

**We can help you find the
correct guide for**

Door preparation template

L809

**We can help you find the
correct guide for**

Door preparation template

L810

L/LV/LM/LMV-Series

Model L9025

ALLEGION™

Door Type: Metal, flat or beveled
 Trim: Escutcheon

For Case and Strike dimensions, see Template L1

Left Hand (LH) Door Shown

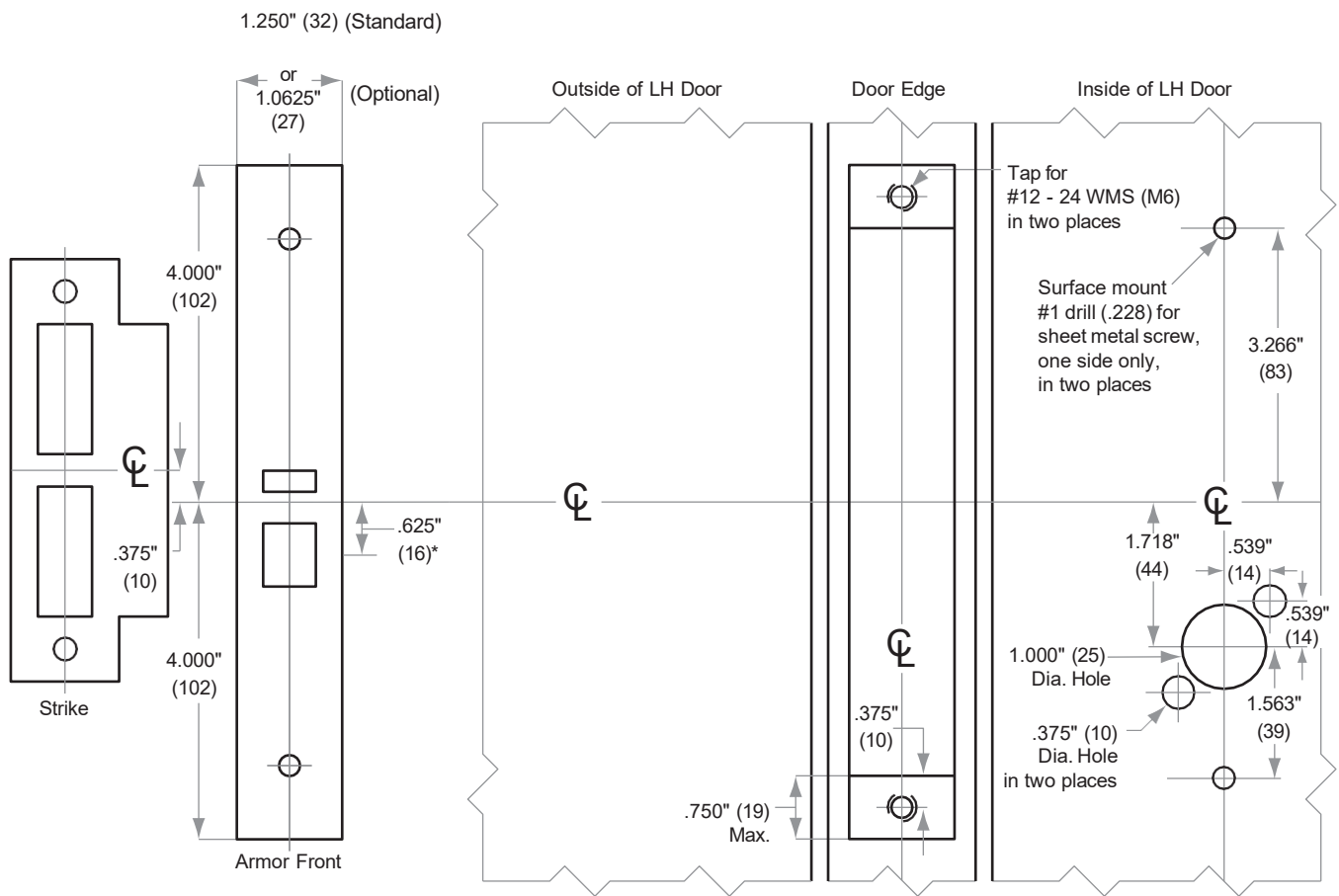

* Centerline of Armor Front to Centerline of Latch dimension

Dimensions shown in parentheses () are in millimeters.

L811 Rev. 12/21

DRAWING IS NOT TO SCALE!
 Customer service: 877-671-7011

© 2021 Allegion

**We can help you find the
correct guide for**

Door preparation template

L811

**We can help you find the
correct guide for**

Door preparation template

L812

L/LV/LM/LMV-Series

Model L9026

ALLEGION™

Door Type: Metal, flat or beveled
 Trim: Rose

For Case and Strike dimensions, see Template L1

Left Hand (LH) Door Shown

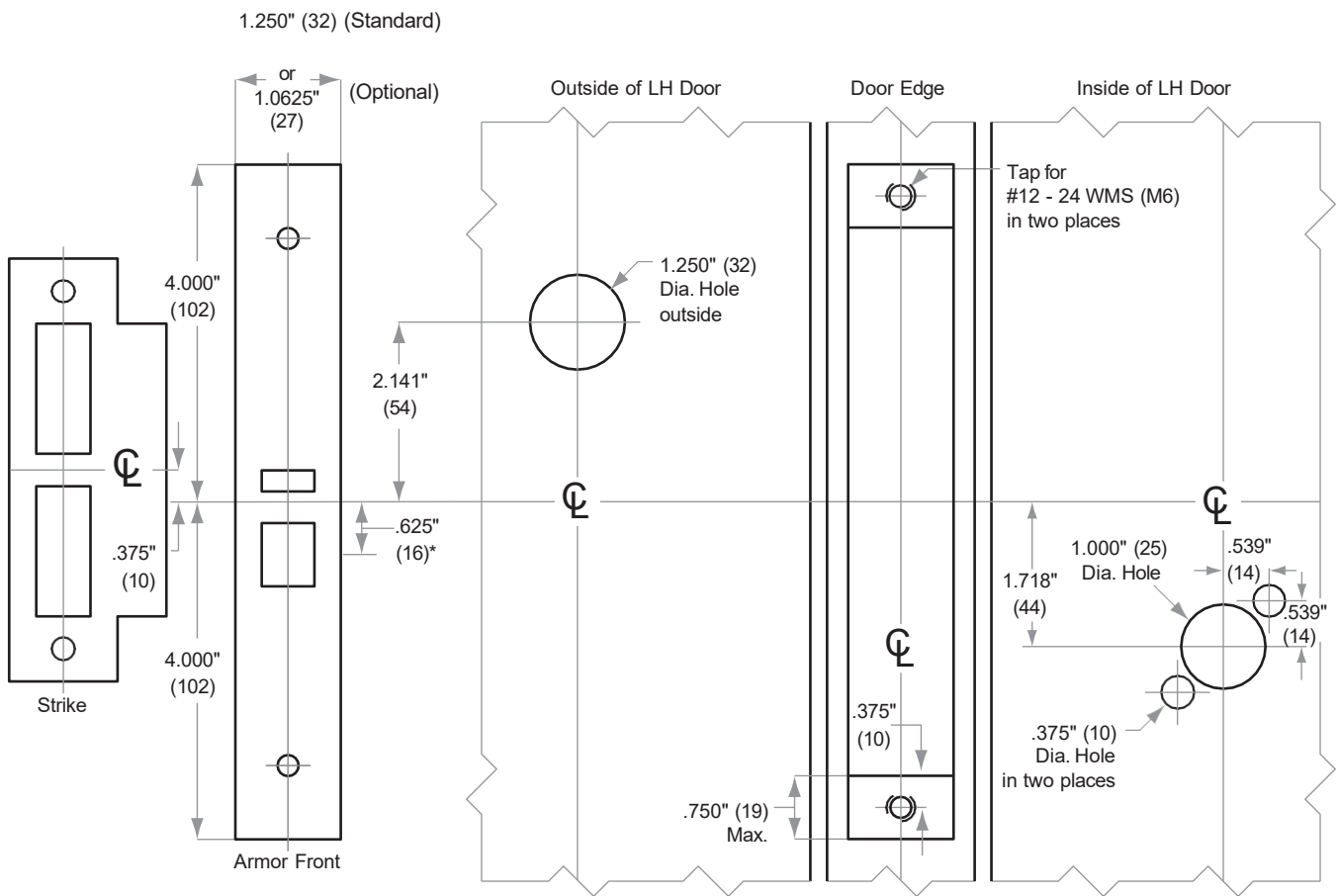

* Centerline of Armor Front to Centerline of Latch dimension

Dimensions shown in parentheses () are in millimeters.

DRAWING IS NOT TO SCALE!

Customer service: 877-671-7011

Door preparation
template

L/LV/LM/LMV-Series

Model L9026

ALLEGION™

Door Type: Wood or composite, flat
 Trim: Escutcheon

For Case and Strike dimensions, see Template L1

Left Hand (LH) Door Shown

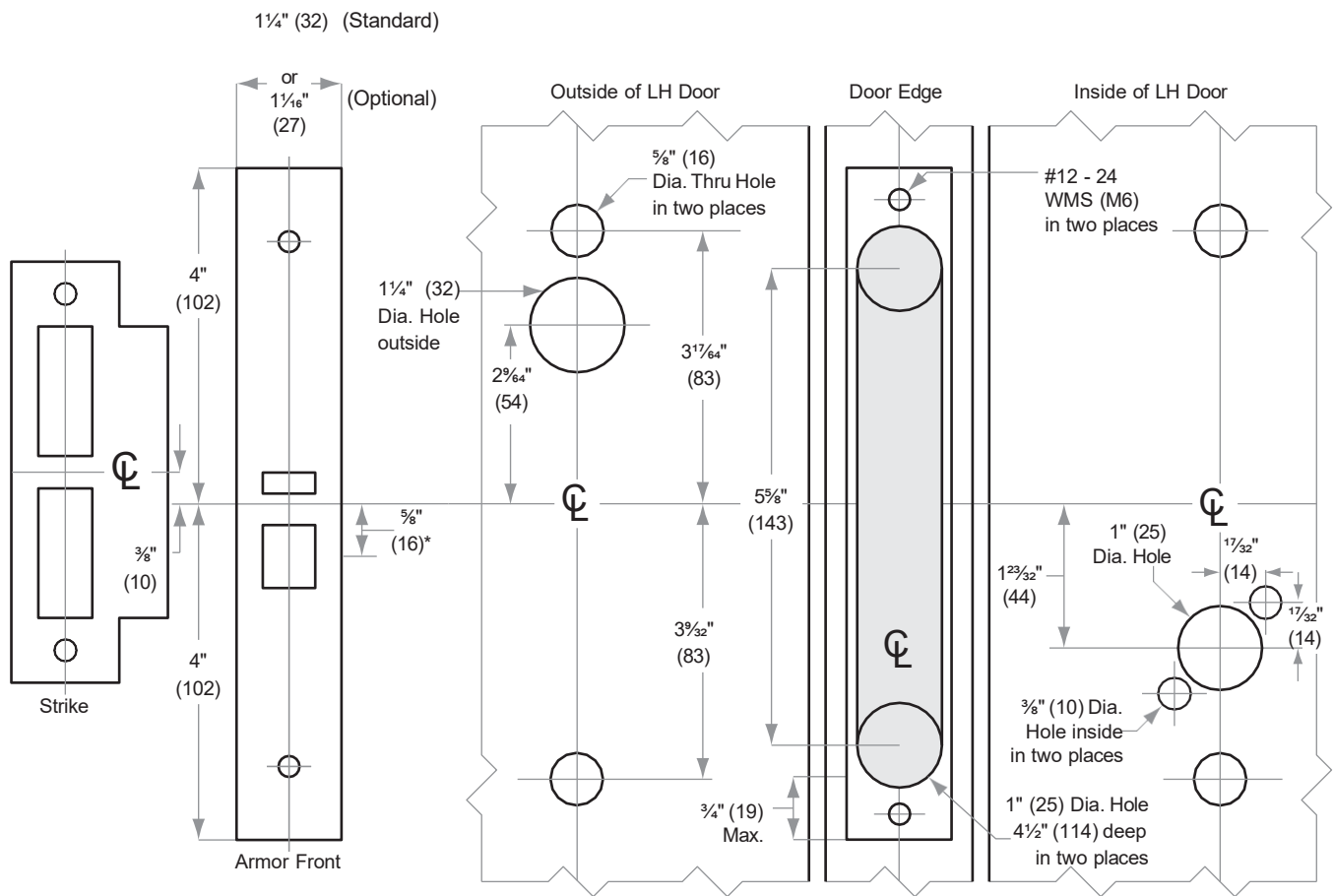

* Centerline of Armor Front to Centerline of Latch dimension

Dimensions shown in parentheses () are in millimeters.

DRAWING IS NOT TO SCALE!

Customer service: 877-671-7011

Door preparation
template

L/LV/LM/LMV-Series

Model L9026

ALLEGION™

Door Type: Metal, flat or beveled
 Trim: Escutcheon

For Case and Strike dimensions, see Template L1

Left Hand (LH) Door Shown

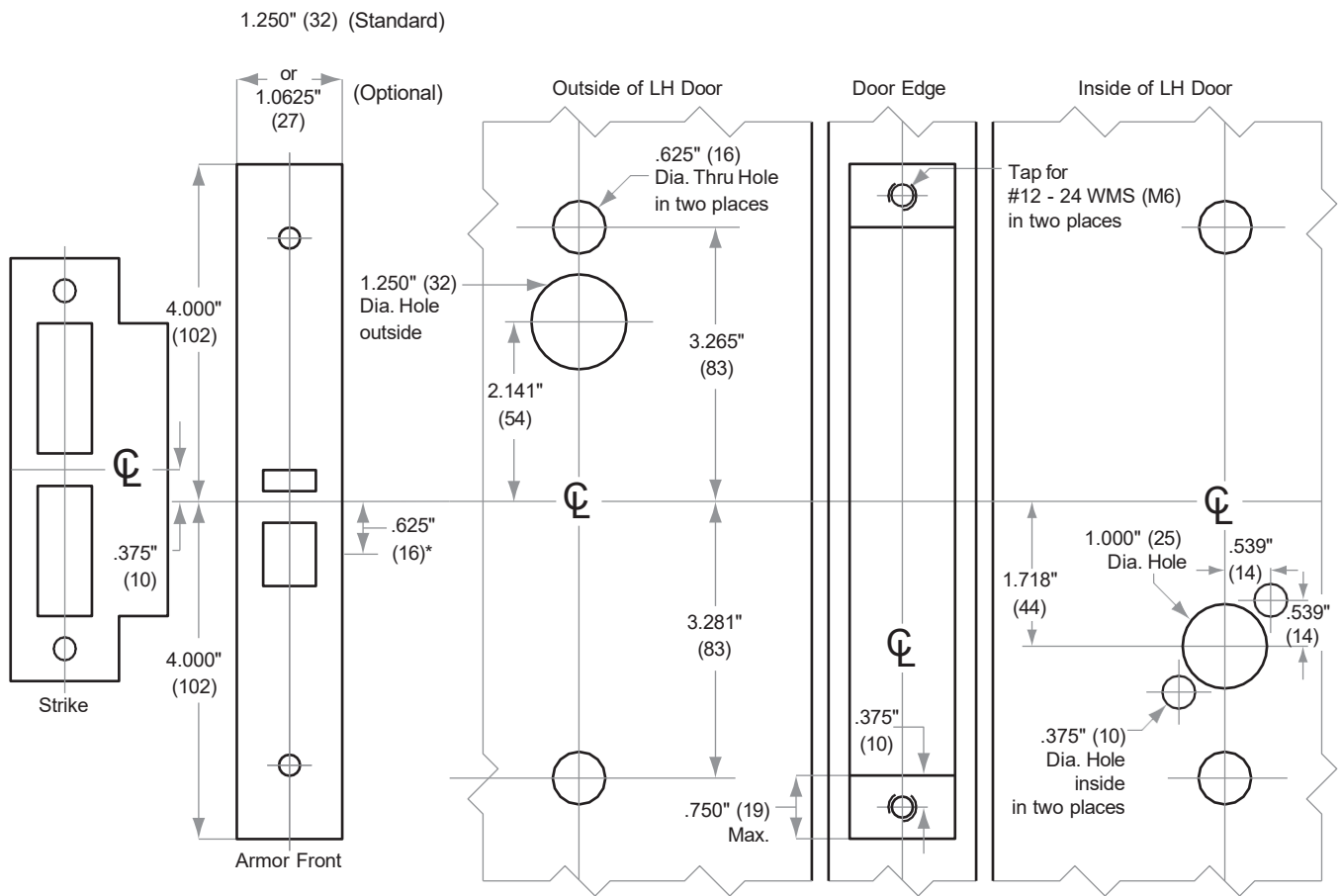

* Centerline of Armor Front to Centerline of Latch dimension

Dimensions shown in parentheses () are in millimeters.

L815 Rev. 12/21

DRAWING IS NOT TO SCALE!
 Customer service: 877-671-7011

© 2021 Allegion

**We can help you find the
correct guide for**

Door preparation template

L815

L/LV/LM/LMV-Series

ALLEGION™

Model L/LV9060, L/LV/LM/LMV9071, L/LV9077,
L/LV9082/EL/EU, L/LV9457, L/LV9458, L9466, L/LV9482

Door Type: Wood or composite, flat or beveled

Trim: Rose

This template should not be used for HSLR trim. Use template L965 for HSLR trim.

**For Case and Strike dimensions, see Template L1
Refer to Template L1 for information to prepare
the door for wire routing**

Left Hand (LH) Door Shown

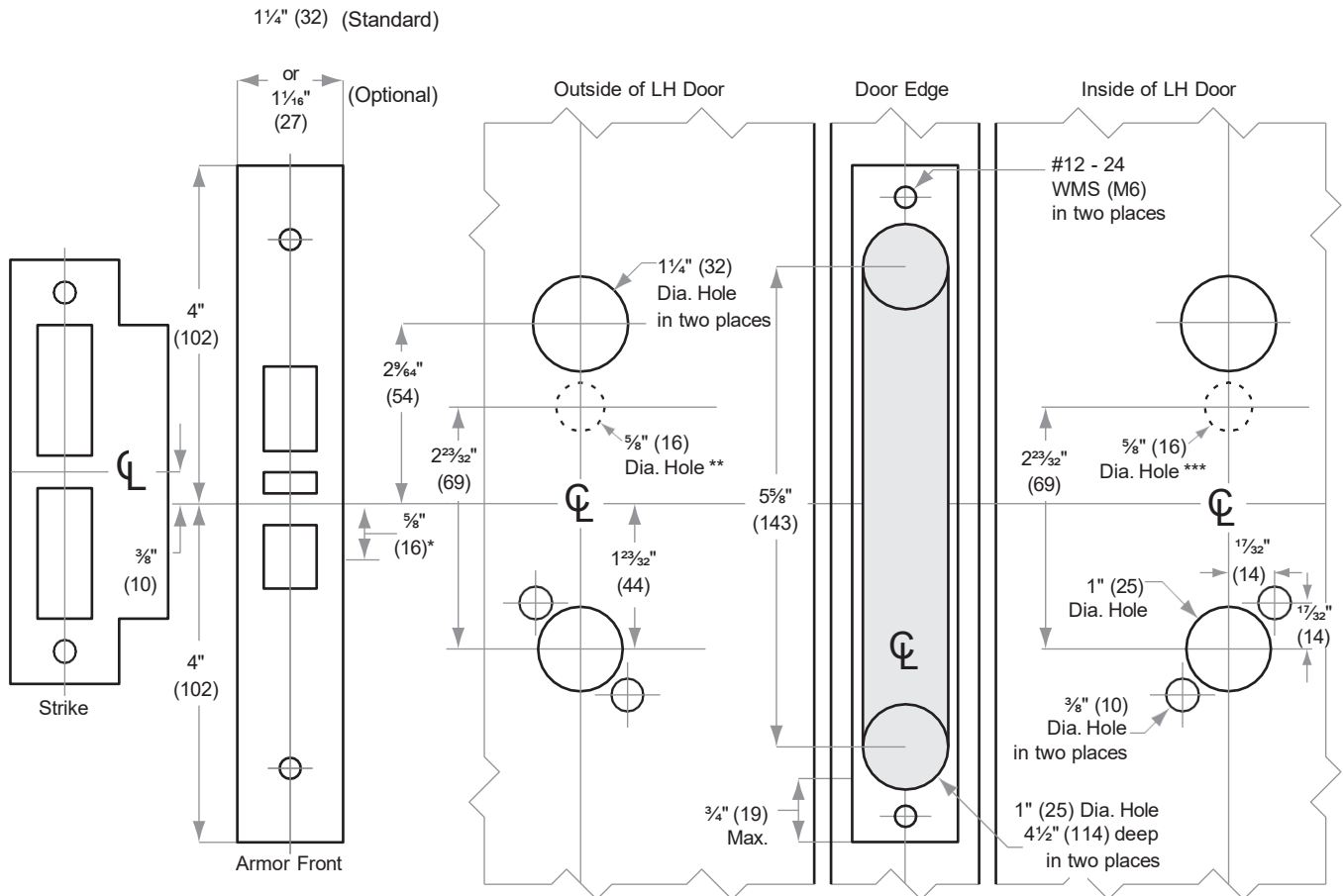

* Centerline of Armor Front to Centerline of Latch dimension

** Additional preparation for L283-721, L283-722, L283-723, L283-724

*** Additional preparation for L283-711, L283-712, L283-713, L283-714

Dimensions shown in parentheses () are in millimeters.

DRAWING IS NOT TO SCALE!

Customer service: 877-671-7011

Door preparation
template

L/LV/LM/LMV-Series

ALLEGION™

Model L/LV9060, L/LV/LM/LMV9071, L/LV9077,
L/LV9082/EL/EU, L/LV9457, L/LV9458, L9466,
L/LV9482, LM/LMV9371

Door Type: Metal, flat or beveled
Trim: Rose

This template should not be used for HSLR trim. Use template L966 for HSLR trim.

For Case and Strike dimensions, see Template L1
Refer to Template L1 for information to prepare
the door for wire routing

Left Hand (LH) Door Shown

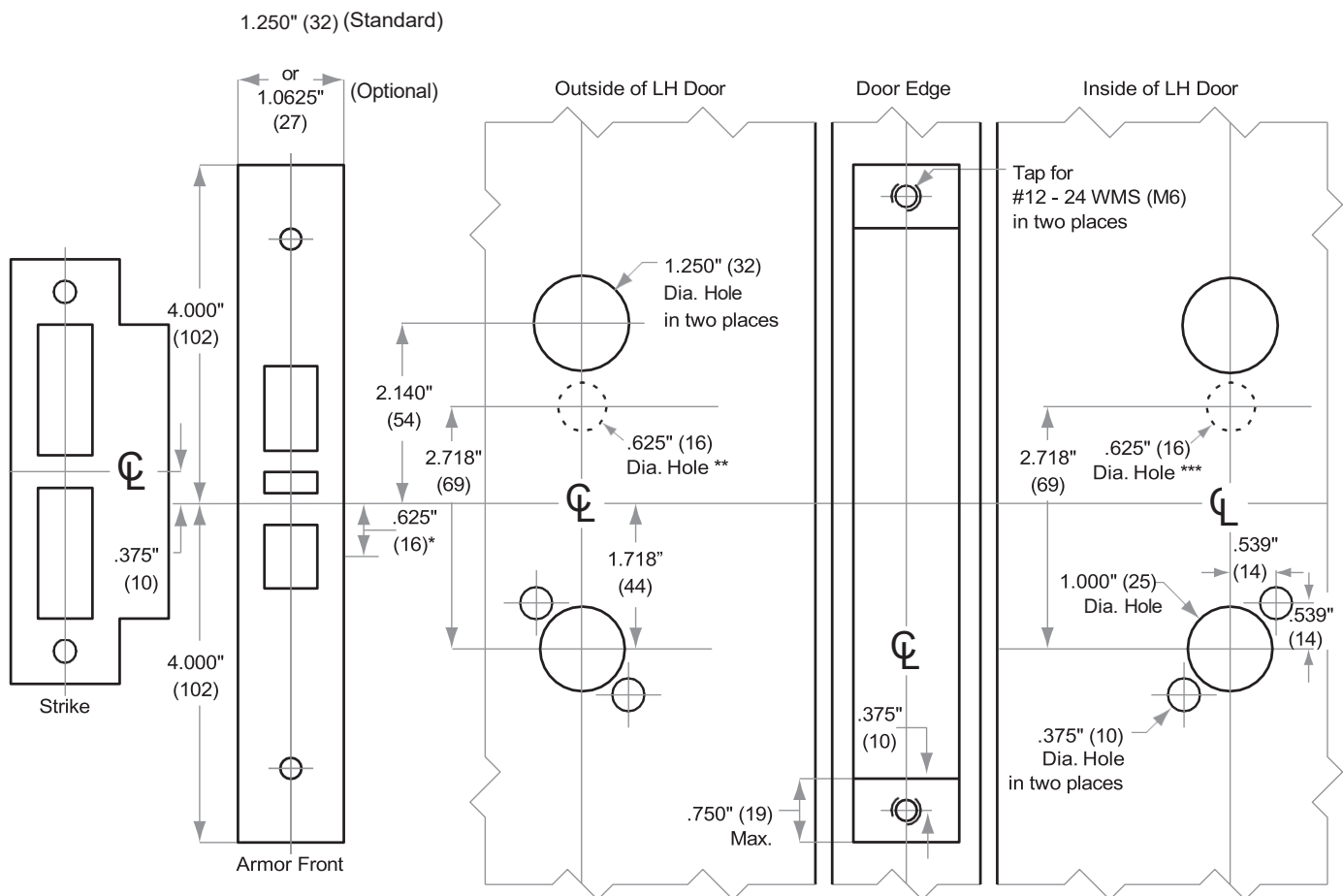

- * Centerline of Armor Front to Centerline of Latch dimension
- ** Additional preparation for L283-721, L283-722, L283-723, L283-724
- *** Additional preparation for L283-711, L283-712, L283-713, L283-714

L817 Rev. 12/21

Dimensions shown in parentheses () are in millimeters.

© 2021 Allegion

DRAWING IS NOT TO SCALE!
Customer service: 877-671-7011

**We can help you find the
correct guide for**

Door preparation template

L817

L/LV/LM/LMV-Series

Model L/LV9486, L/LV9496

ALLEGION™

Door Type: Wood or composite, flat or beveled
 Trim: Rose

For Case and Strike dimensions, see Template L1

Left Hand (LH) Door Shown

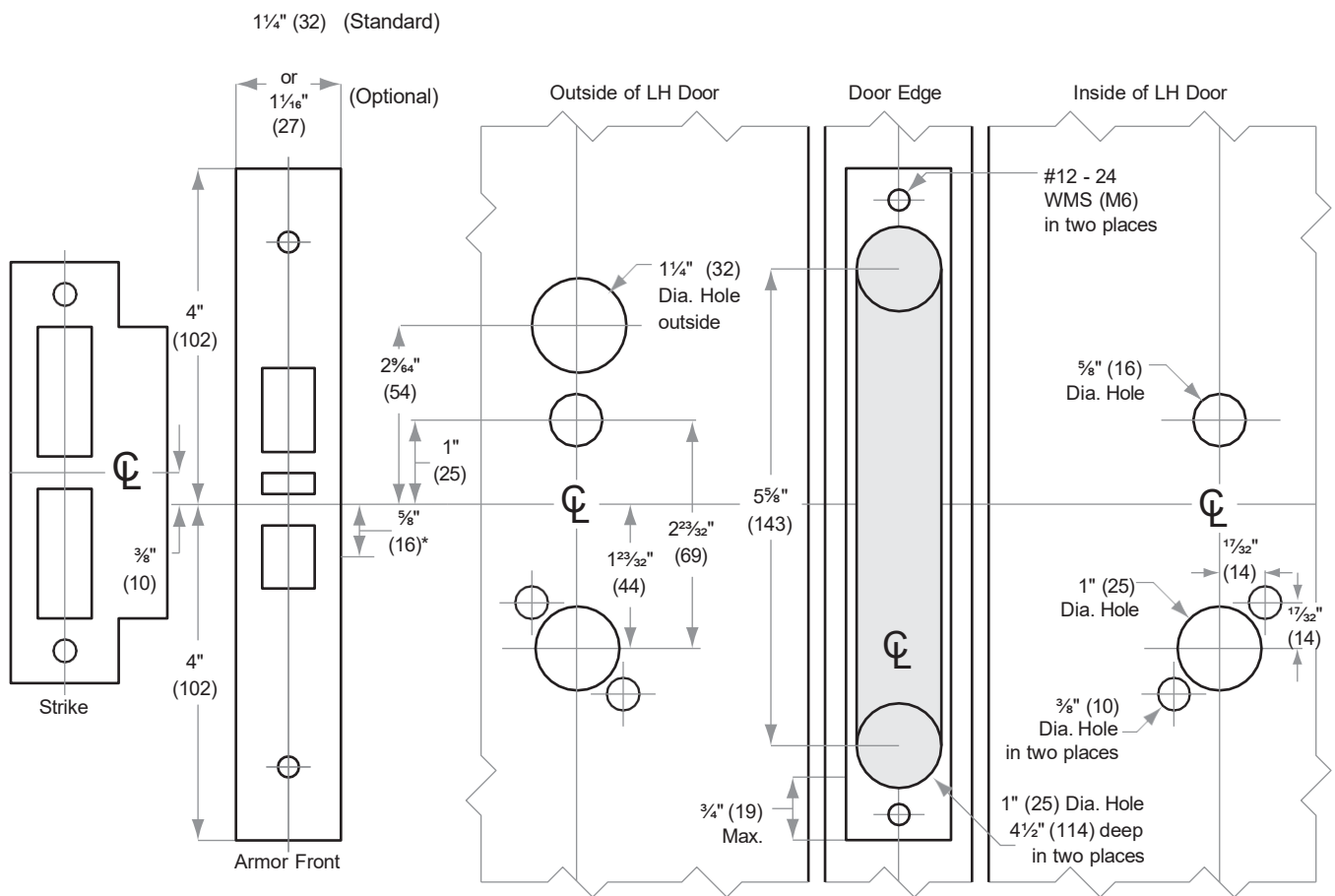

*Centerline of Armor Front to Centerline of Latch dimension

Dimensions shown in parentheses () are in millimeters.

L820 Rev. 12/21

DRAWING IS NOT TO SCALE!
 Customer service: 877-671-7011

© 2021 Allegion

**We can help you find the
correct guide for**

Door preparation template

L820

L/LV/LM/LMV-Series

Model L/LV9486, L/LV9496

ALLEGION™

Door Type: Metal, flat or beveled
 Trim: Rose

For Case and Strike dimensions, see Template L1

Left Hand (LH) Door Shown

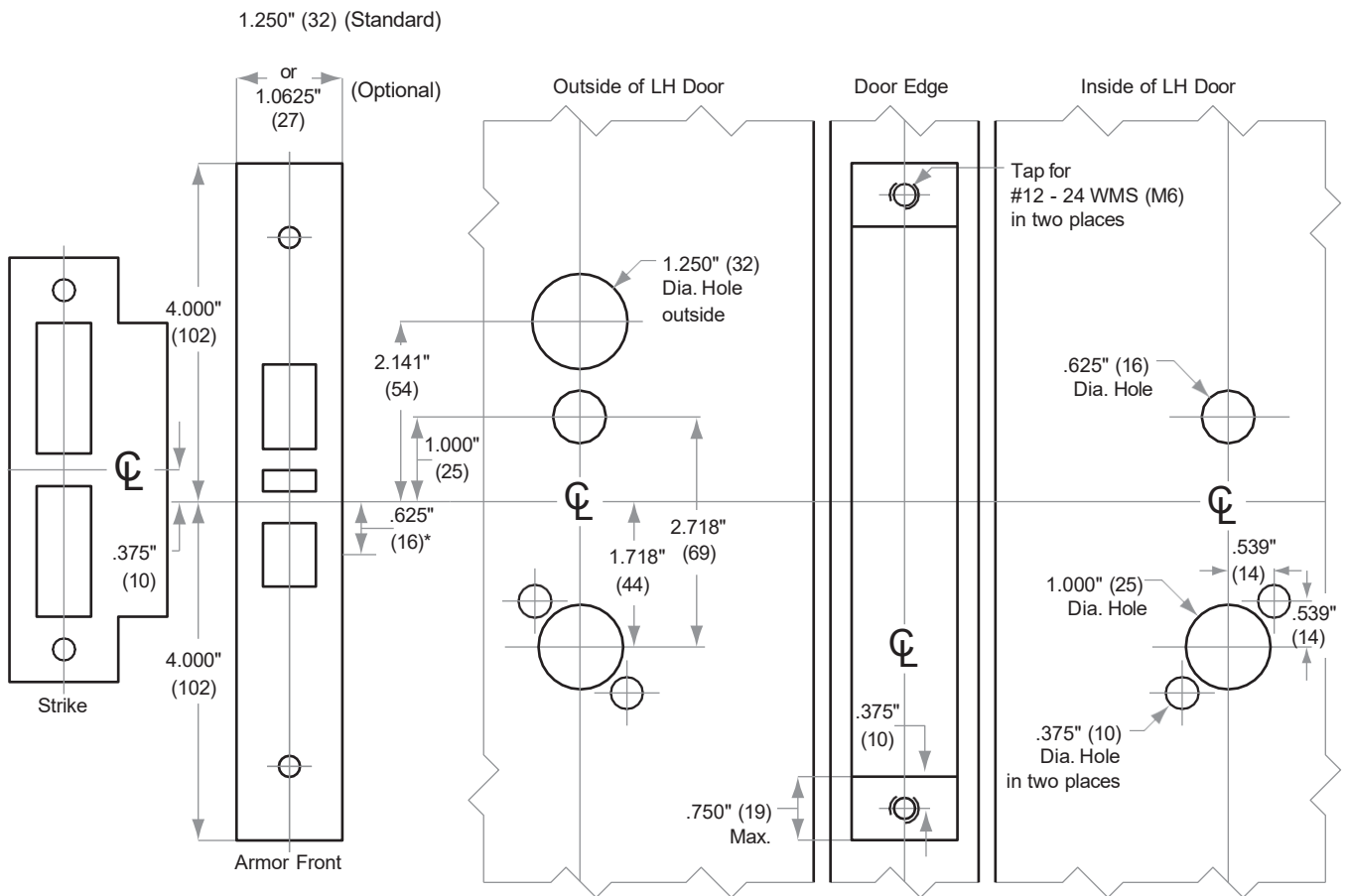

*Centerline of Armor Front to Centerline of Latch dimension

Dimensions shown in parentheses () are in millimeters.

L821 Rev. 12/21

DRAWING IS NOT TO SCALE!
 Customer service: 877-671-7011

**We can help you find the
correct guide for**

Door preparation template

L821

L/LV/LM/LMV-Series

ALLEGION™

Model L/LV9050, L/LV9056, L/LV9453, L/LV9456,
L9473, L/LV9480, L/LV9485

Door Type: Wood or composite, flat or beveled

Trim: Escutcheon

This template should not be used for HSLR trim. Use template L965 for HSLR trim.

For Case and Strike dimensions, see Template L1

Left Hand (LH) Door Shown

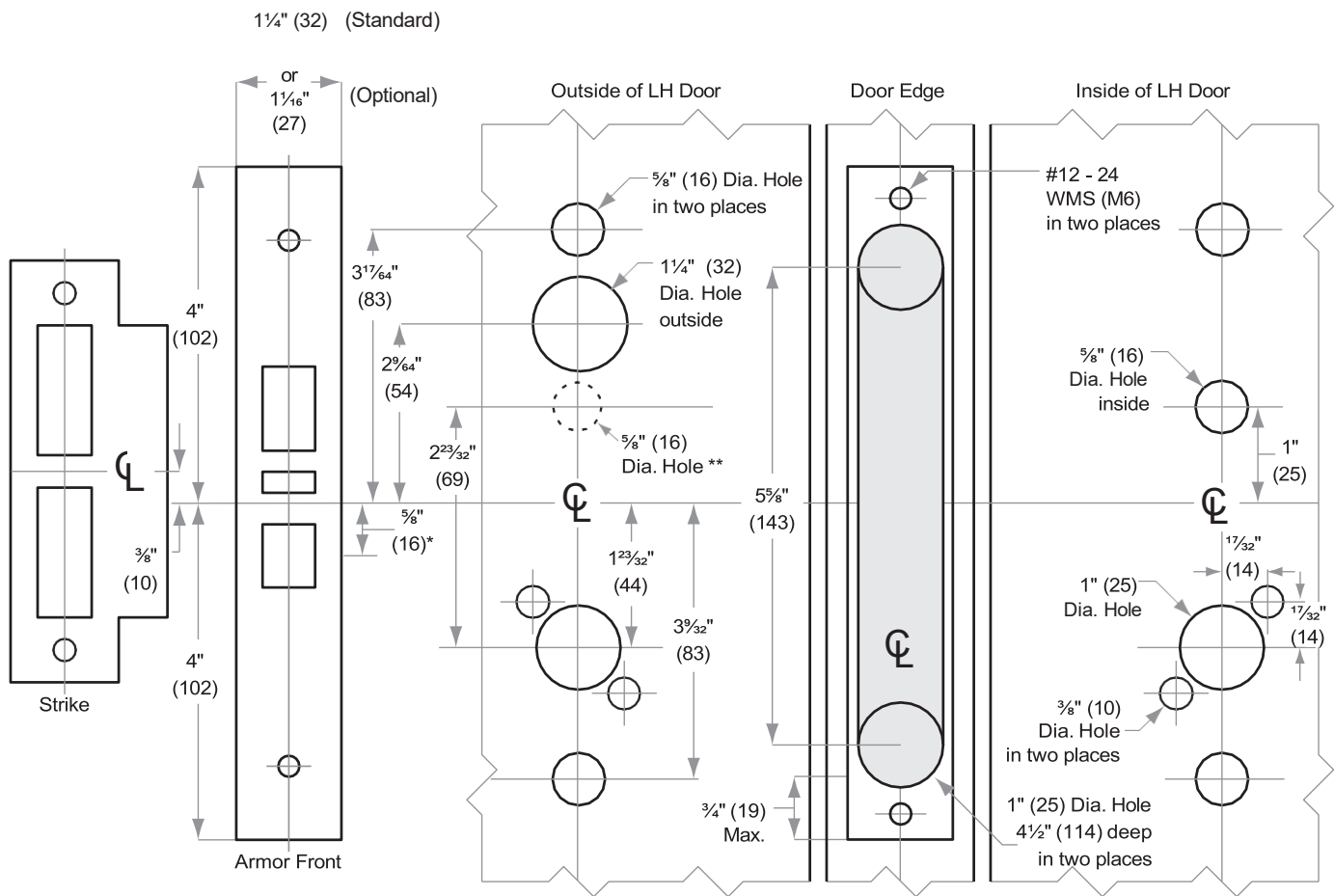

* Centerline of Armor Front to Centerline of Latch dimension

** Additional preparation for L283-721, L283-722, L283-723, L283-724

Dimensions shown in parentheses () are in millimeters.

DRAWING IS NOT TO SCALE!

Customer service: 877-671-7011

Door preparation
template

L/LV/LM/LMV-Series

ALLEGION™

Model L/LV/LM/LMV9050, L/LV/LM/LMV9056, L/LV9453,
L/LV9456, L9473, L/LV9480, L/LV9485, LM/LMV9350,
LM/LMV9356

Door Type: Metal, flat or beveled
Trim: Escutcheon

This template should not be used for HSLR trim. Use template L966 for HSLR trim.

For Case and Strike dimensions, see Template L1

Left Hand (LH) Door Shown

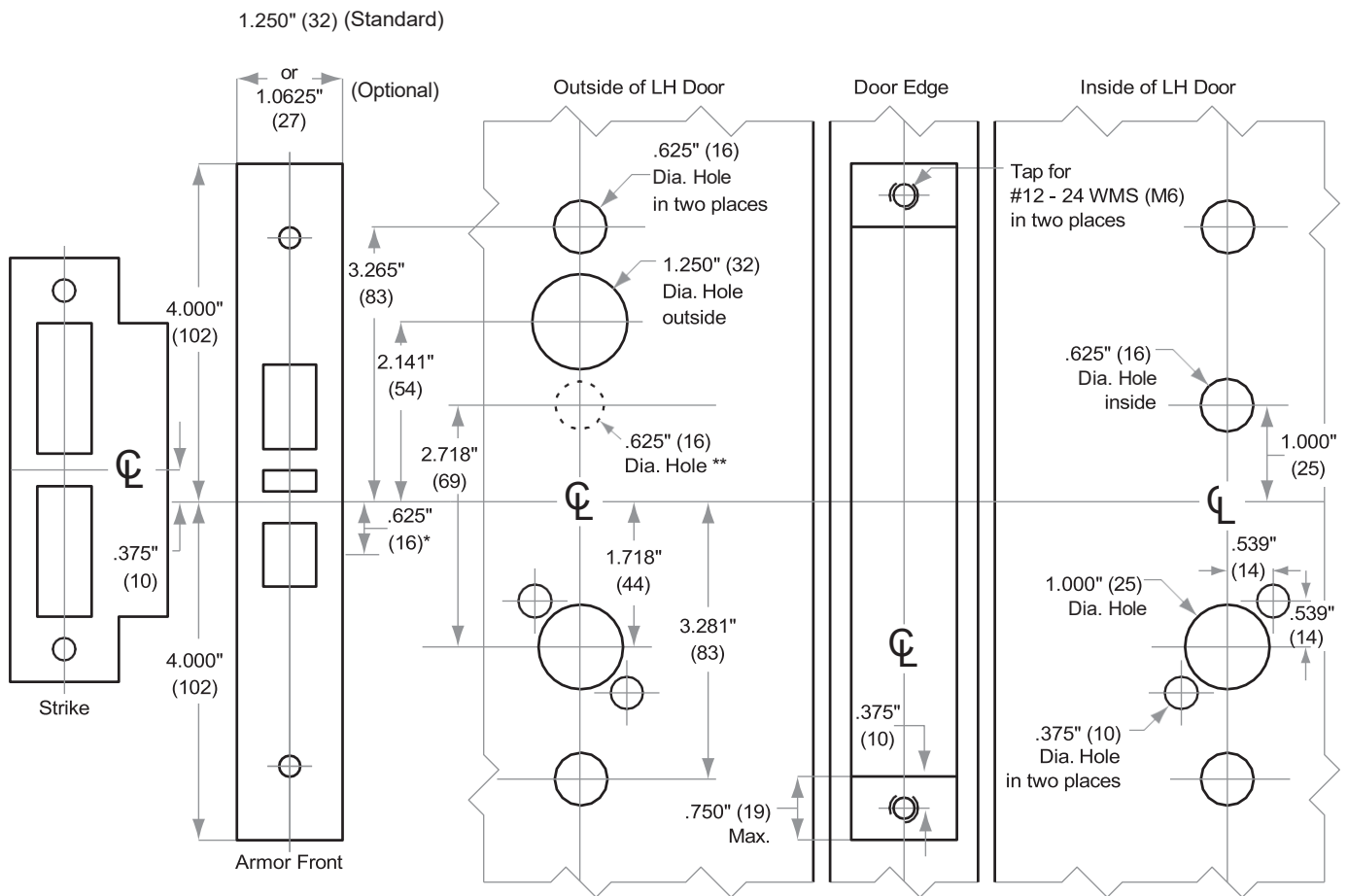

* Centerline of Armor Front to Centerline of Latch dimension
** Additional preparation for L283-721, L283-722, L283-723, L283-724

Door preparation
template

L/LV/LM/LMV-Series

ALLEGION™

Model L/LV9060, L/LV9071, L/LV9077, L/LV9082/EL/EU,
L/LV9457, L/LV9458, L9466, L/LV9482

Door Type: Wood or composite, flat or beveled

Trim: Escutcheon

This template should not be used for HSLR trim. Use template L965 for HSLR trim.

For Case and Strike dimensions, see Template L1
Refer to Template L1 for information to prepare
the door for wire routing

Left Hand (LH) Door Shown

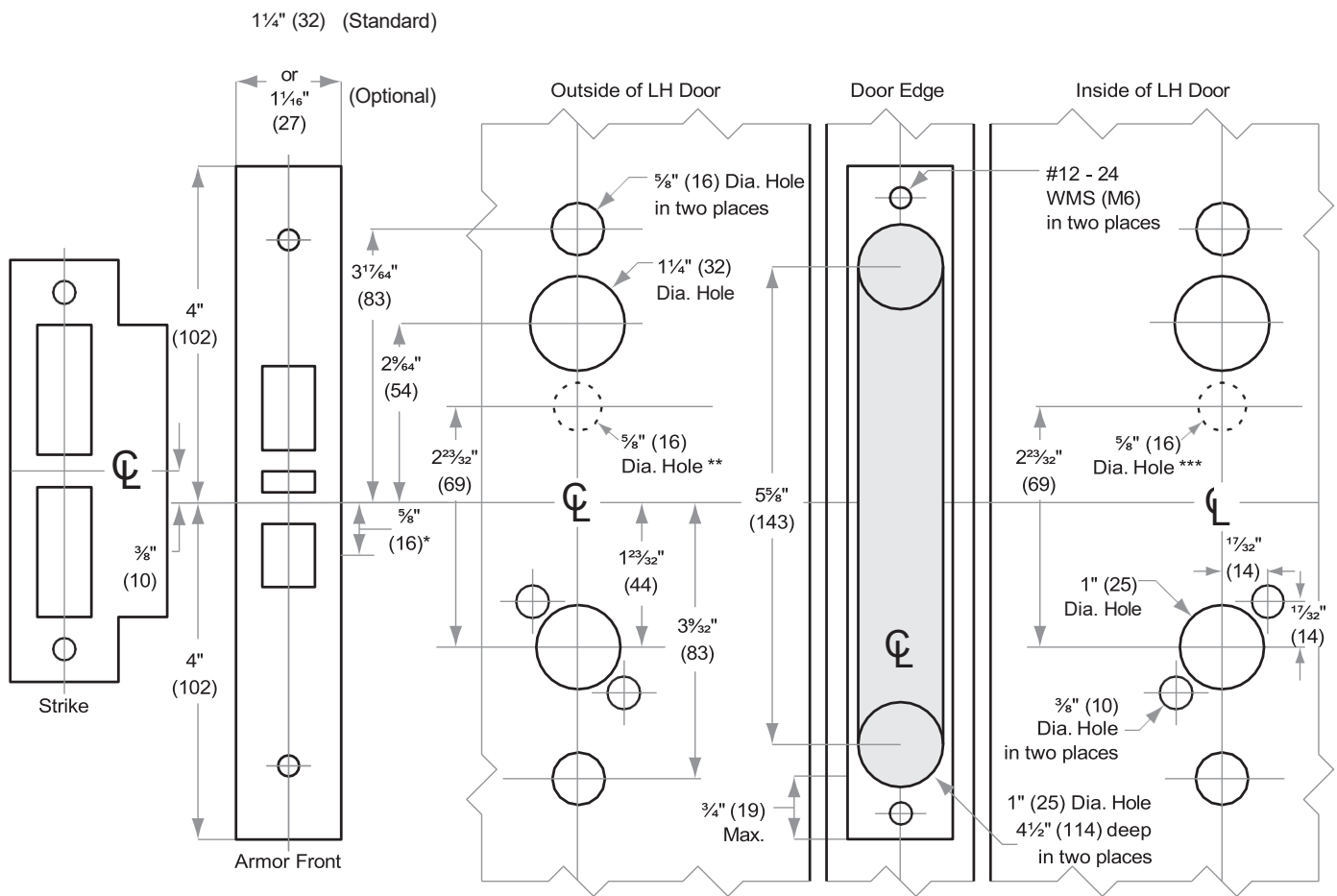

* Centerline of Armor Front to Centerline of Latch dimension

** Additional preparation for L283-721, L283-722, L283-723, L283-724

*** Additional preparation for L283-711, L283-712, L283-713, L283-714

Dimensions shown in parentheses () are in millimeters.

DRAWING IS NOT TO SCALE!

Customer service: 877-671-7011

Door preparation
template

L/LV/LM/LMV-Series

ALLEGION™

Model L/LV9060, L/LV/LM/LMV9071, L/LV9077, L/LV9082EL/EU, L/LV9457, L/LV9458, L9466, L/LV9482, LM/LMV9371

Door Type: Metal, flat or beveled

Trim: Escutcheon

This template should not be used for HSLR trim. Use template L966 for HSLR trim.

**For Case and Strike dimensions, see Template L1
Refer to Template L1 for information to prepare
the door for wire routing**

Left Hand (LH) Door Shown

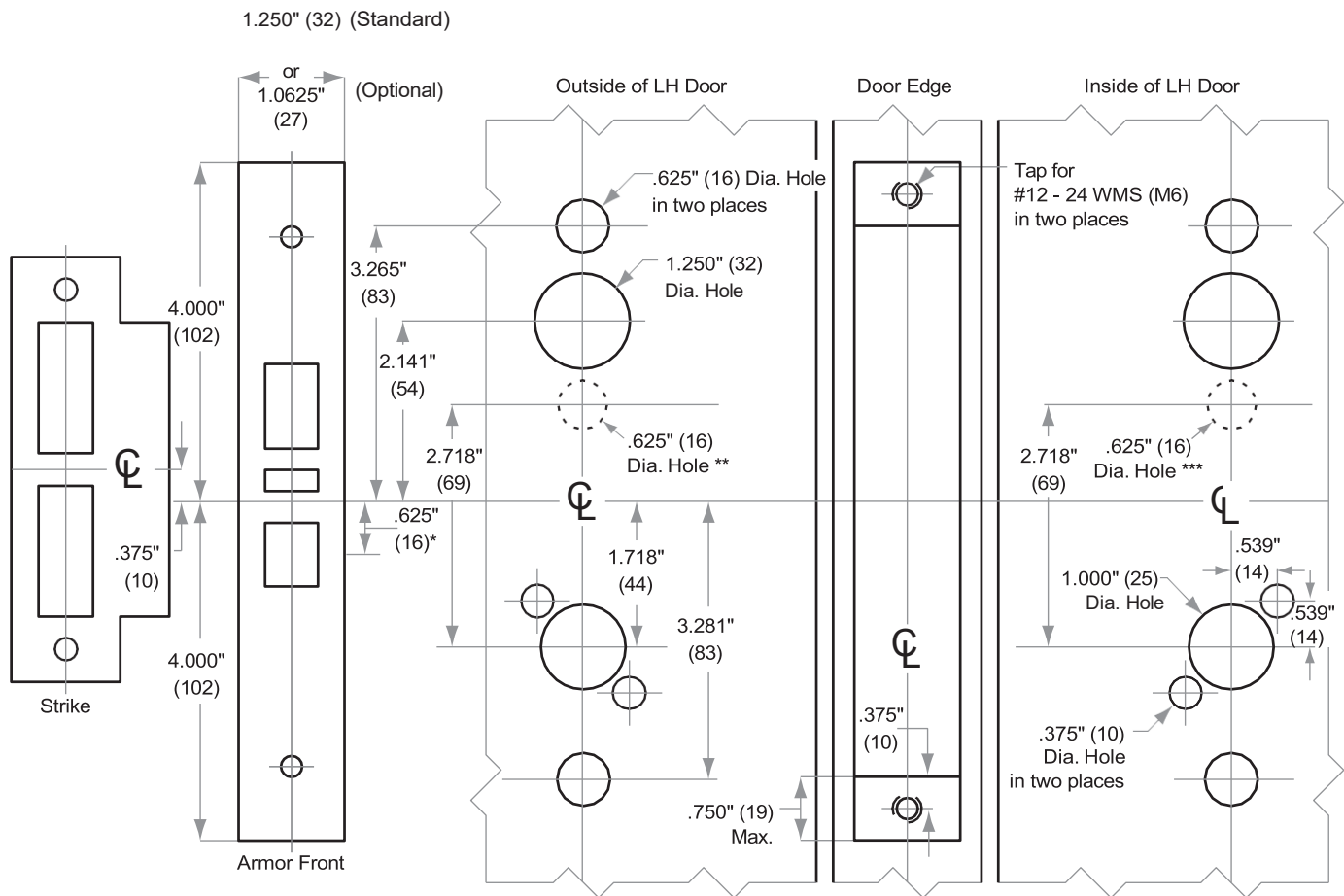

- * Centerline of Armor Front to Centerline of Latch dimension
- ** Additional preparation for L283-721, L283-722, L283-723, L283-724
- *** Additional preparation for L283-711, L283-712, L283-713, L283-714

L829 Rev. 12/21

Dimensions shown in parentheses () are in millimeters.

**DRAWING IS NOT TO SCALE!
Customer service: 877-671-7011**

**We can help you find the
correct guide for**

Door preparation template

L829

L/LV/LM/LMV-Series

Model L9175

ALLEGION™

Door Type: Wood or composite, flat or beveled
Trim: Rose

For Case dimensions see Template L1

Left Hand (LH) Door Shown

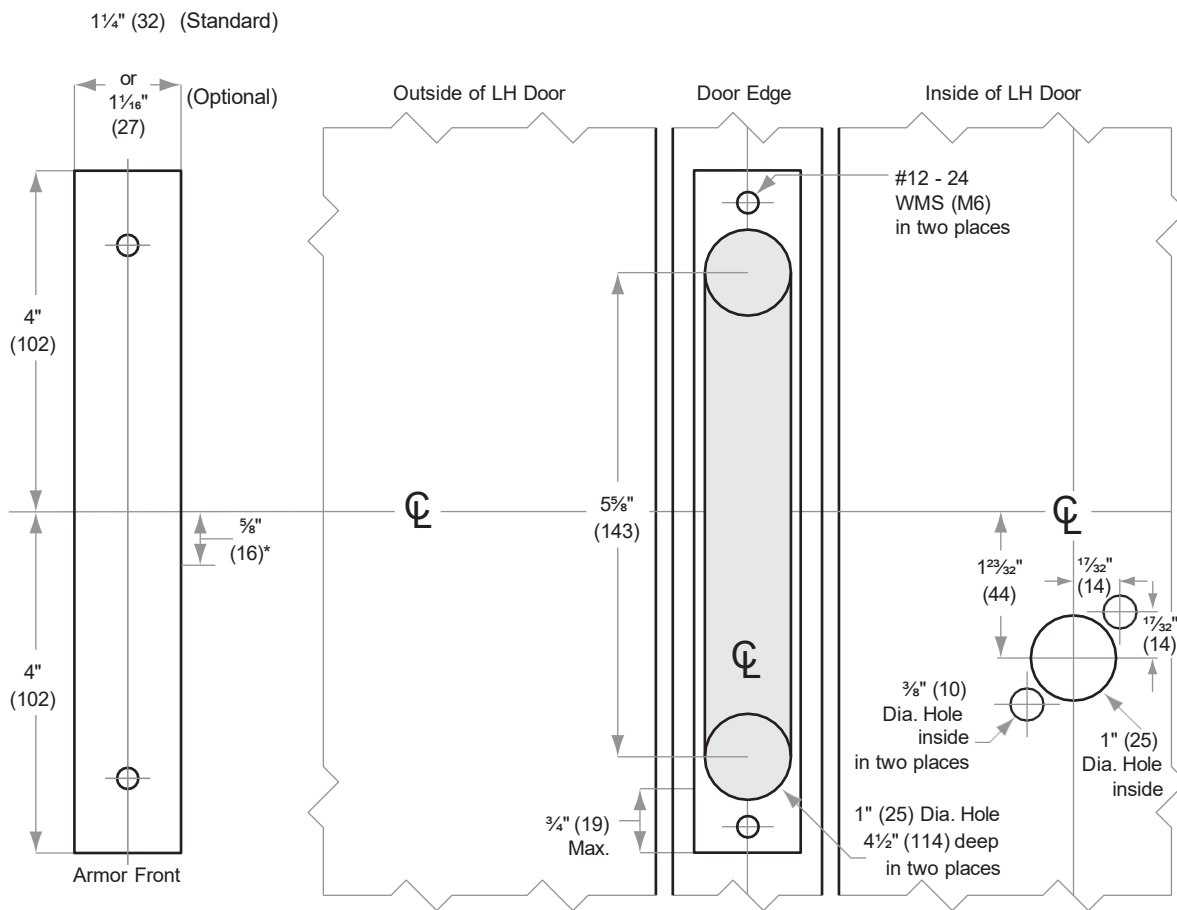

* Centerline of Armor Front to Centerline of Latch dimension

L851 Rev. 12/21

Dimensions shown in parentheses () are in millimeters.

© 2021 Allegion

DRAWING IS NOT TO SCALE!
Customer service: 877-671-7011

**We can help you find the
correct guide for**

Door preparation template

L851

L/LV/LM/LMV-Series

Model L9176

ALLEGION™

Door Type: Wood or composite, flat or beveled
Trim: Rose

For Case and Strike dimensions, see Template L1

Left Hand (LH) Door Shown

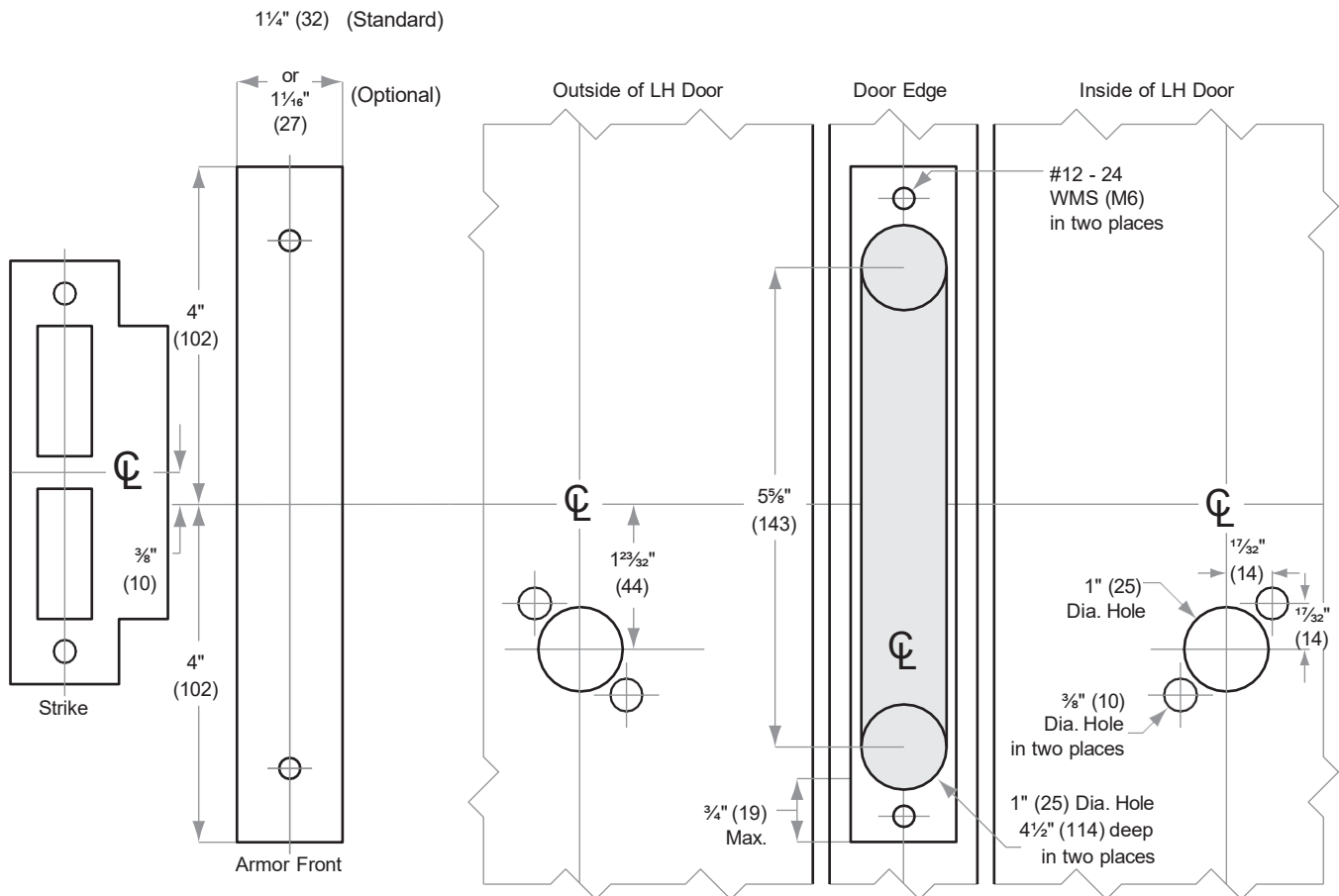

Dimensions shown in parentheses () are in millimeters.

L852 Rev. 12/21

DRAWING IS NOT TO SCALE!
Customer service: 877-671-7011

© 2021 Allegion

**We can help you find the
correct guide for**

Door preparation template

L852

L/LV/LM/LMV-Series

Model L9175, LM9325

ALLEGION™

Door Type: Metal, flat or beveled
 Trim: Escutcheon

For Case and Strike dimensions, see Template L1

Left Hand (LH) Door Shown

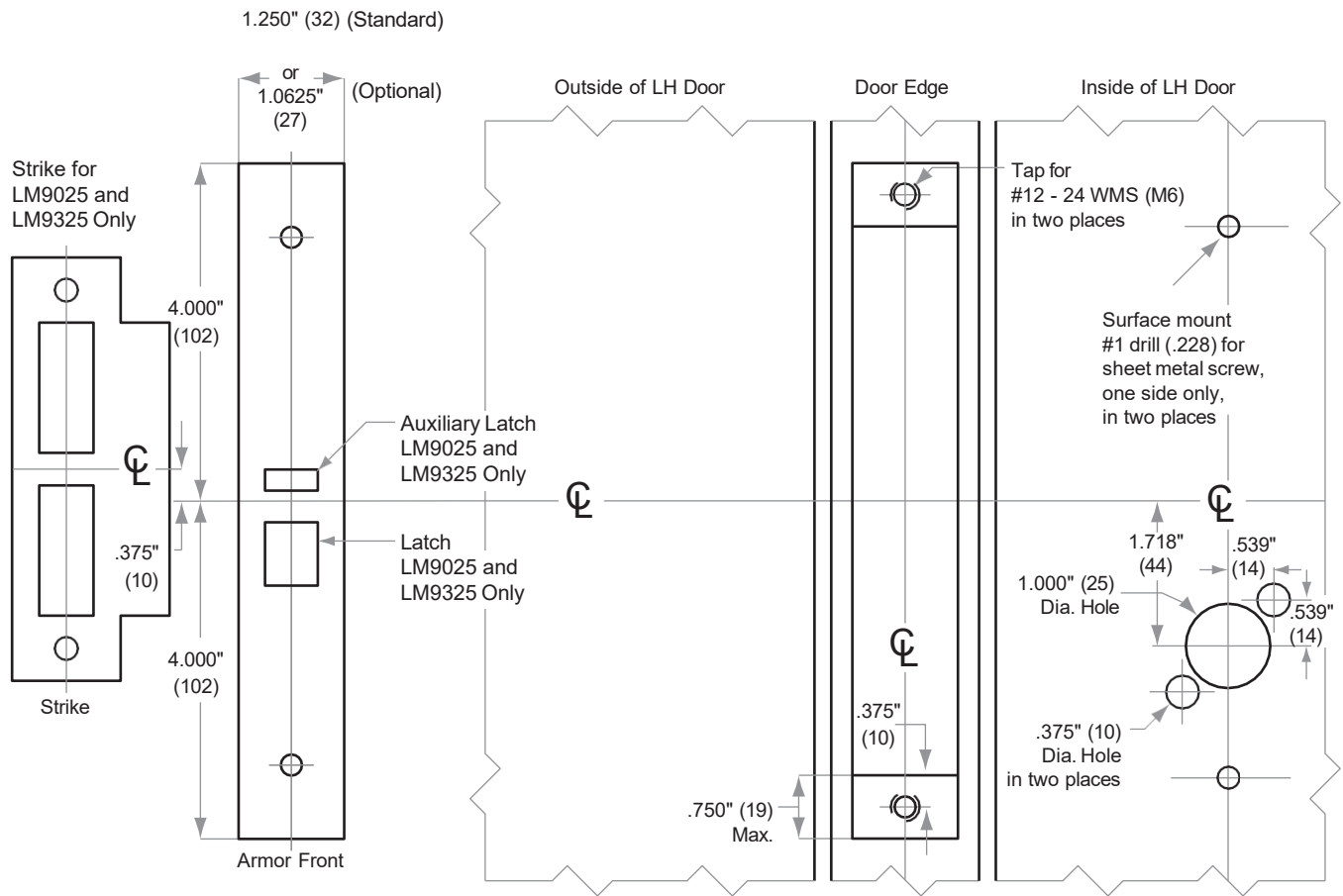

Dimensions shown in parentheses () are in millimeters.

L855 Rev. 12/21

© 2021 Allegion

DRAWING IS NOT TO SCALE!
Customer service: 877-671-7011

**We can help you find the
correct guide for**

Door preparation template

L855

L/LV/LM/LMV-Series

Model L9176

ALLEGION™

Door Type: Metal, flat or beveled
 Trim: Escutcheon

For Case and Strike dimensions, see Template L1

Left Hand (LH) Door Shown

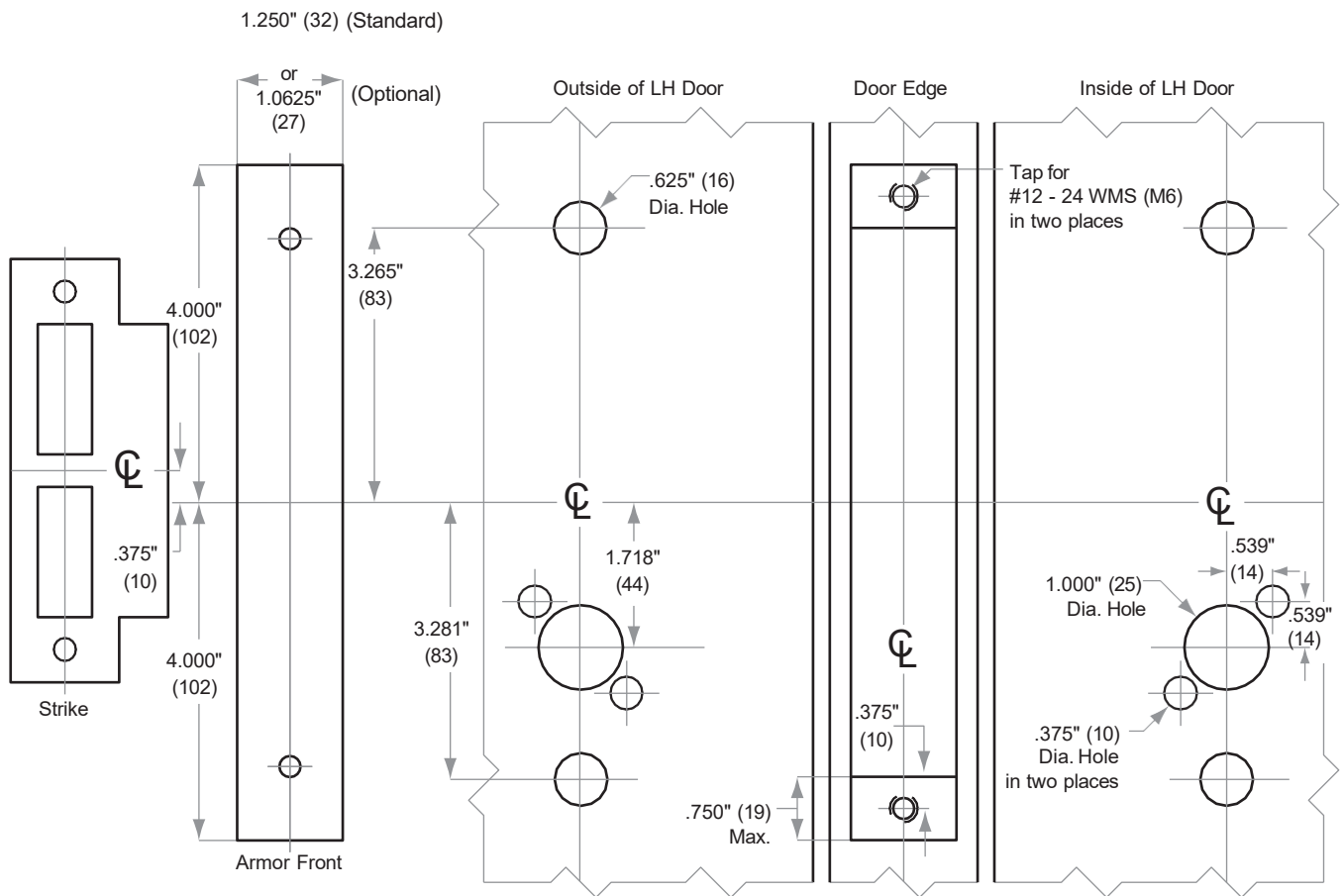

Dimensions shown in parentheses () are in millimeters.

DRAWING IS NOT TO SCALE!

Customer service: 877-671-7011

Door preparation
template

L/LV/LM/LMV-Series

Model L9175

ALLEGION™

Door Type: Wood or composite, flat or beveled
Trim: Escutcheon

For Case and Strike dimensions, see Template L1

Left Hand (LH) Door Shown

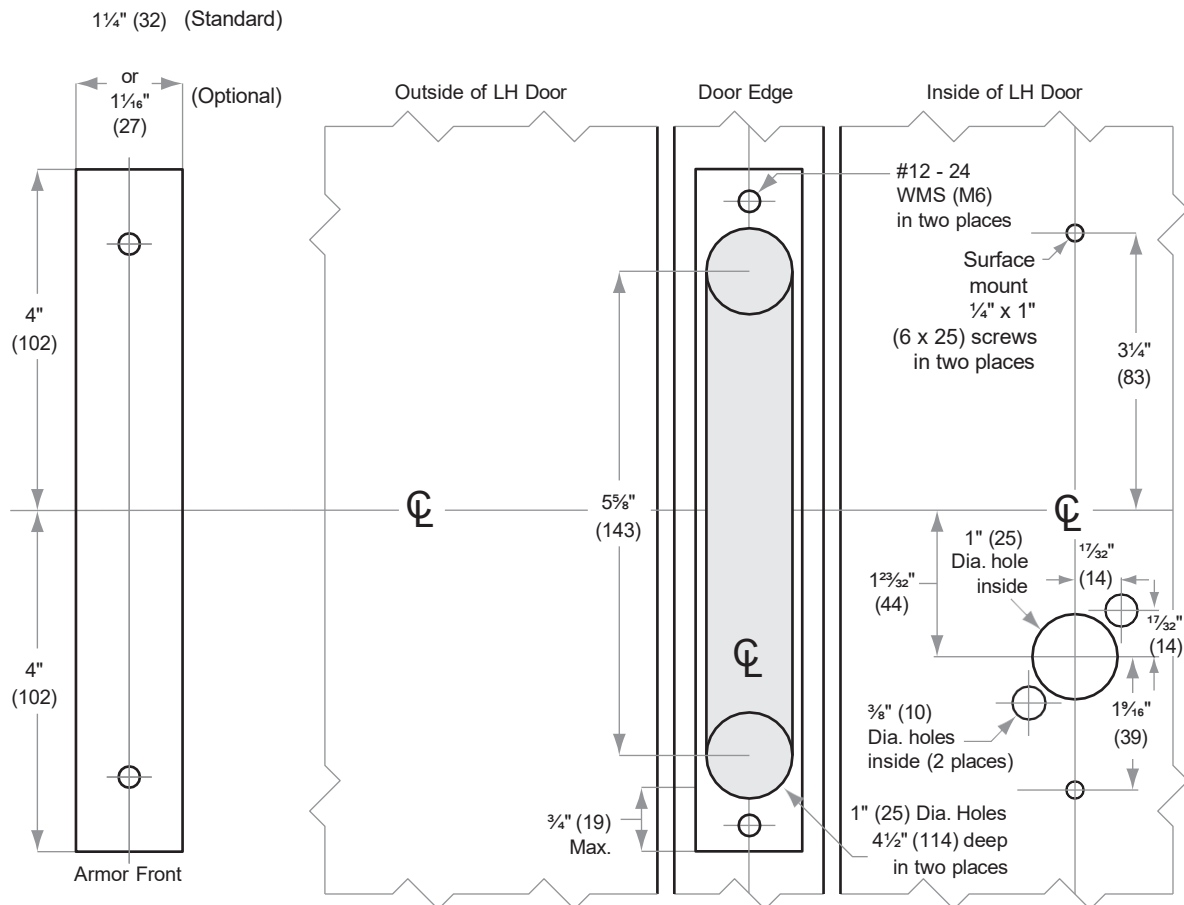

Dimensions shown in parentheses () are in millimeters.

L859 Rev. 12/21

DRAWING IS NOT TO SCALE!
Customer service: 877-671-7011

**We can help you find the
correct guide for**

Door preparation template

L859

L/LV/LM/LMV-Series

Model L9176

ALLEGION™

Door Type: Wood or composite, flat or beveled
Trim: Escutcheon

For Case and Strike dimensions, see Template L1

Left Hand (LH) Door Shown

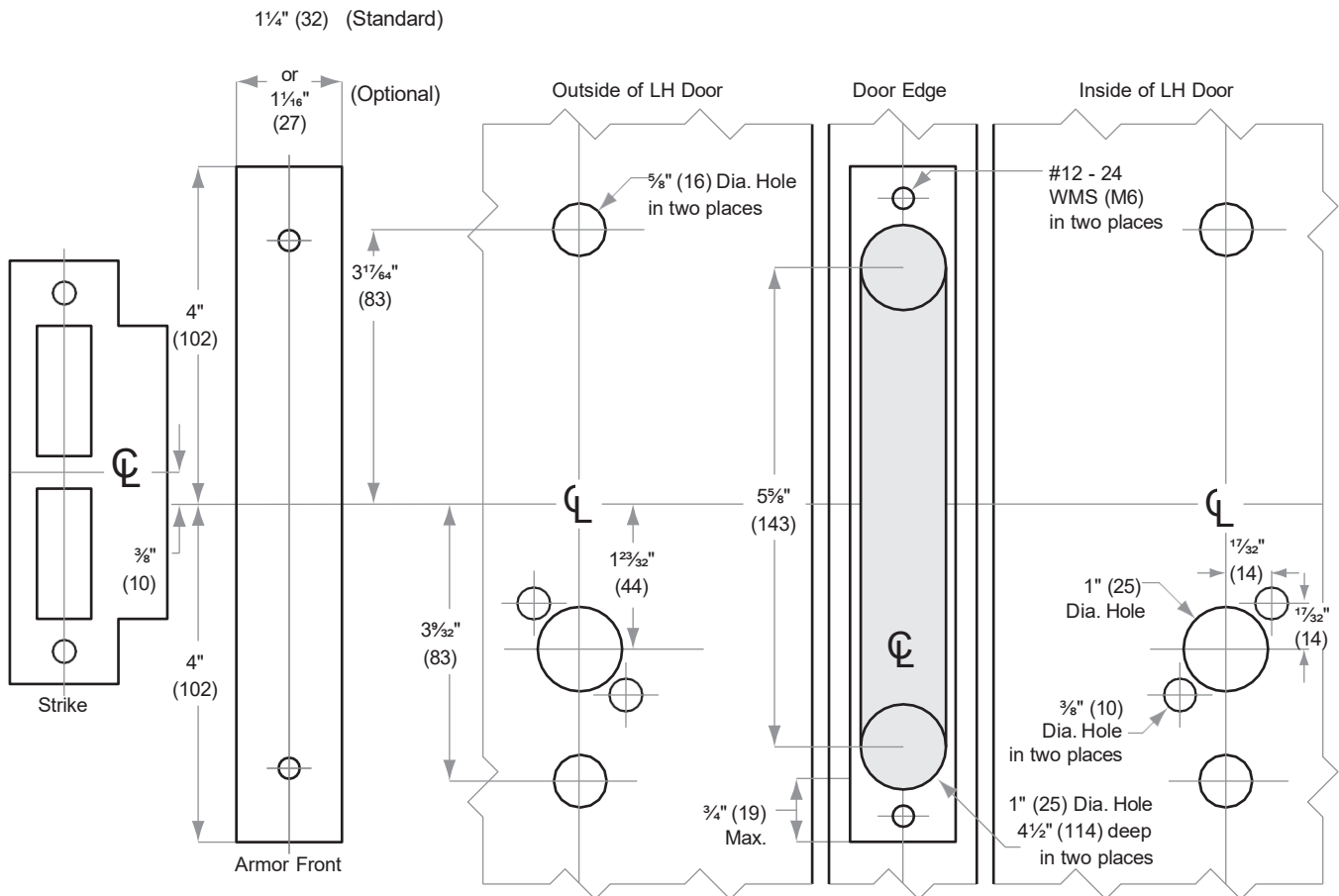

Dimensions shown in parentheses () are in millimeters.

DRAWING IS NOT TO SCALE!

Customer service: 877-671-7011

Door preparation
template

L/LV/LM/LMV-Series

Model L9010, L9110

ALLEGION™

Door Type: Wood or composite, flat or beveled
Trim: Rose

This template should not be used for HSLR trim. Use template L965 for HSLR trim.

For Case and Strike dimensions, see Template L1

Left Hand (LH) Door Shown

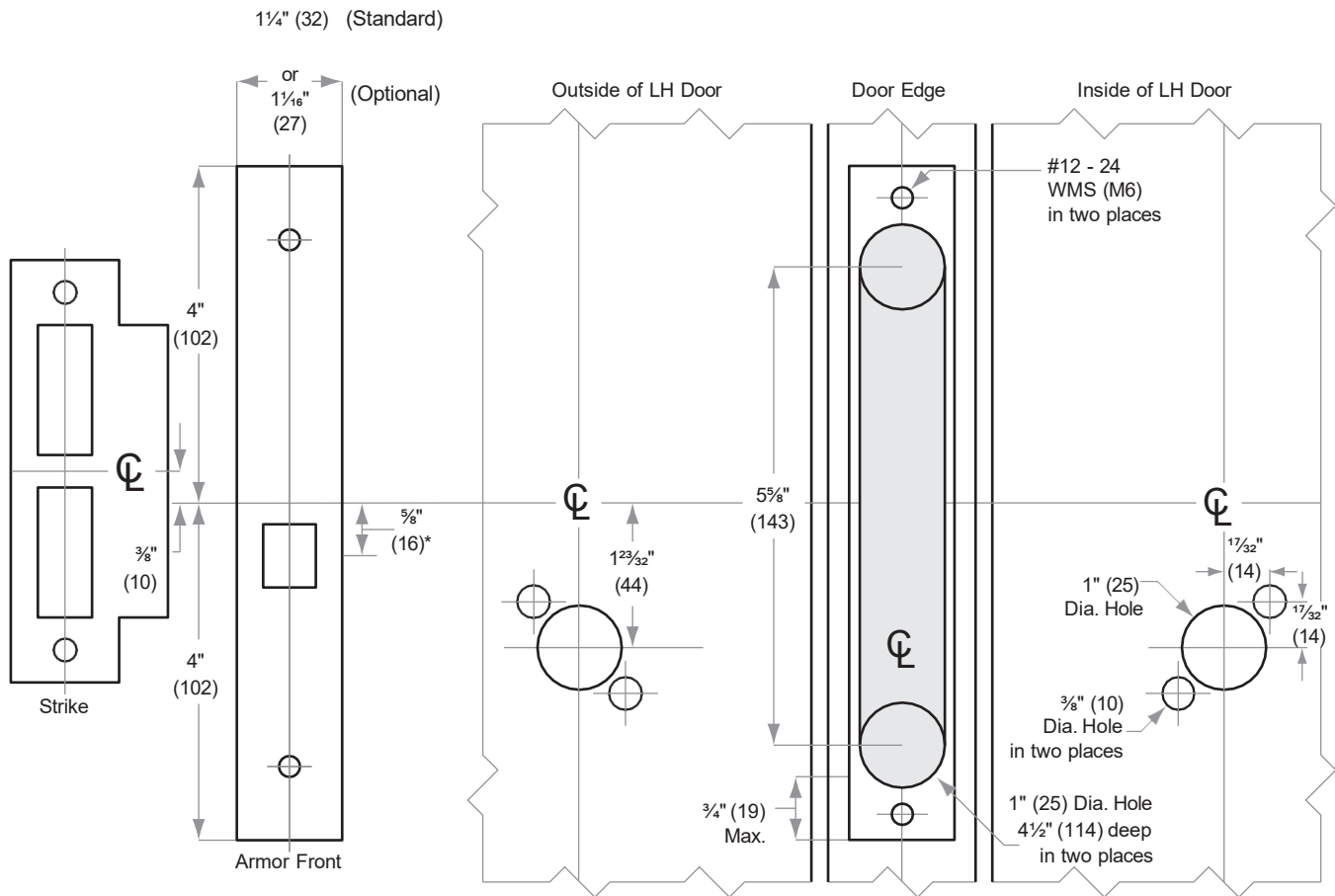

Dimensions shown in parentheses () are in millimeters.

DRAWING IS NOT TO SCALE!

Customer service: 877-671-7011

Door preparation
template

L/LV/LM/LMV-Series

Model L9010, L9110, LM9310

ALLEGION™

Door Type: Metal, flat or beveled
 Trim: Rose

This template should not be used for HSLR trim. Use template L966 for HSLR trim.

For Case and Strike dimensions, see Template L1

Left Hand (LH) Door Shown

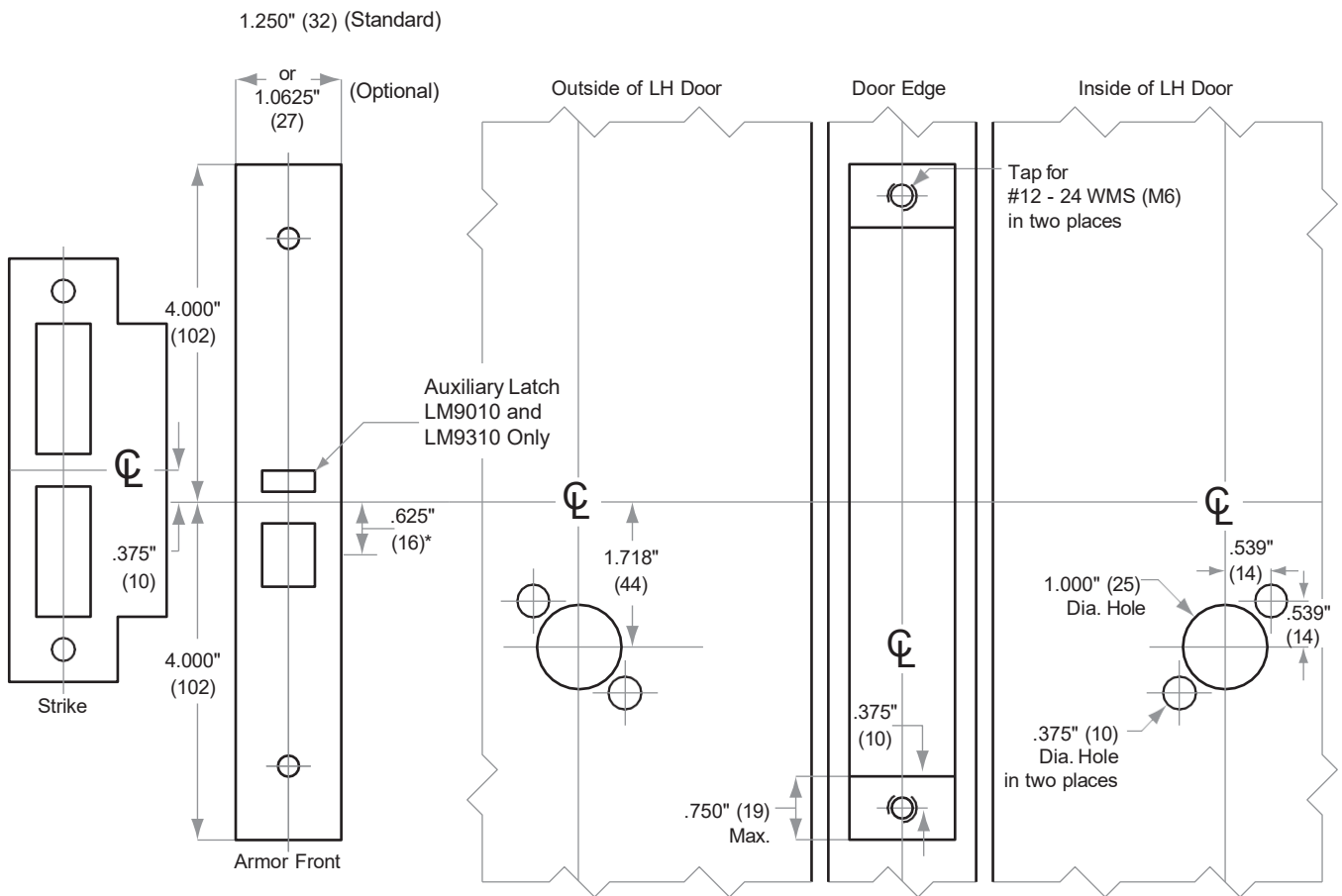

*Centerline of Armor Front to Centerline of Latch dimension

Dimensions shown in parentheses () are in millimeters.

DRAWING IS NOT TO SCALE!

Customer service: 877-671-7011

Door preparation
template

L/LV/LM/LMV-Series

ALLEGION™

Model L/LV9040, L/LV9044, L/LV9440, L/LV9444

Door Type: Wood or composite, flat or beveled

Trim: Rose

This template should not be used for HSLR trim. Use template L965 for HSLR trim.

For Case and Strike dimensions, see Template L1

Left Hand (LH) Door Shown

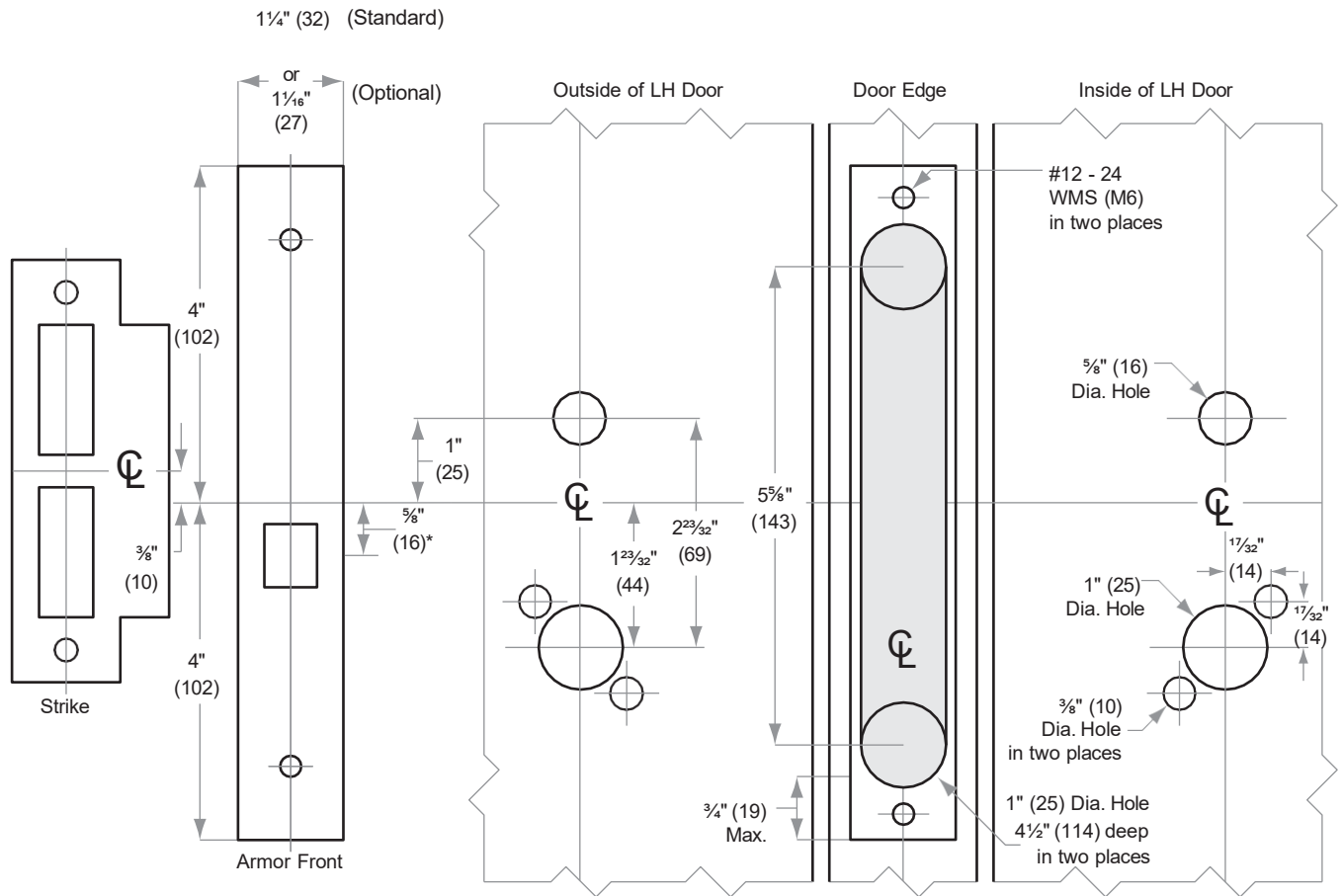

*Centerline of Armor Front to Centerline of Latch dimension

Dimensions shown in parentheses () are in millimeters.

DRAWING IS NOT TO SCALE!

Customer service: 877-671-7011

Door preparation
template

L/LV/LM/LMV-Series

ALLEGION™

Model L/LV9040, L/LV9044, L/LV9440, L/LV9444

Door Type: Metal flat or beveled

Trim: Rose

This template should not be used for HSLR trim. Use template L966 for HSLR trim.

For Case and Strike dimensions, see Template L1

Left Hand (LH) Door Shown

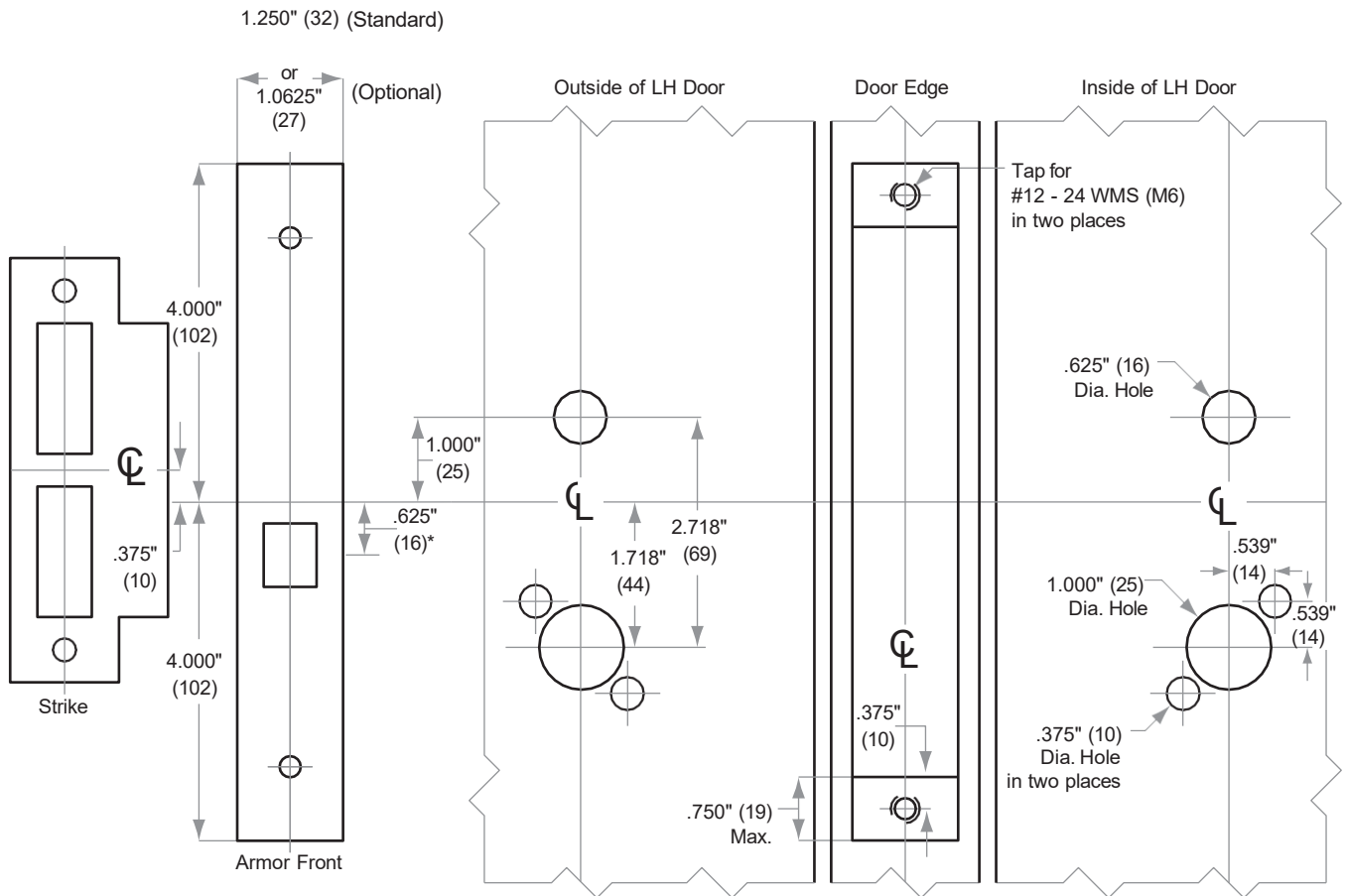

*Centerline of Armor Front to Centerline of Latch dimension

Dimensions shown in parentheses () are in millimeters.

DRAWING IS NOT TO SCALE!

Customer service: 877-671-7011

Door preparation
template

L/LV/LM/LMV-Series

ALLEGION™

Model L/LV9050, L/LV9056, L/LV9453, L/LV9456, L9473,
L/LV9480, L/LV9485

Door Type: Wood or composite, flat or beveled

Trim: Rose

This template should not be used for HSLR trim. Use template L965 for HSLR trim.

For Case and Strike dimensions, see Template L1

Left Hand (LH) Door Shown

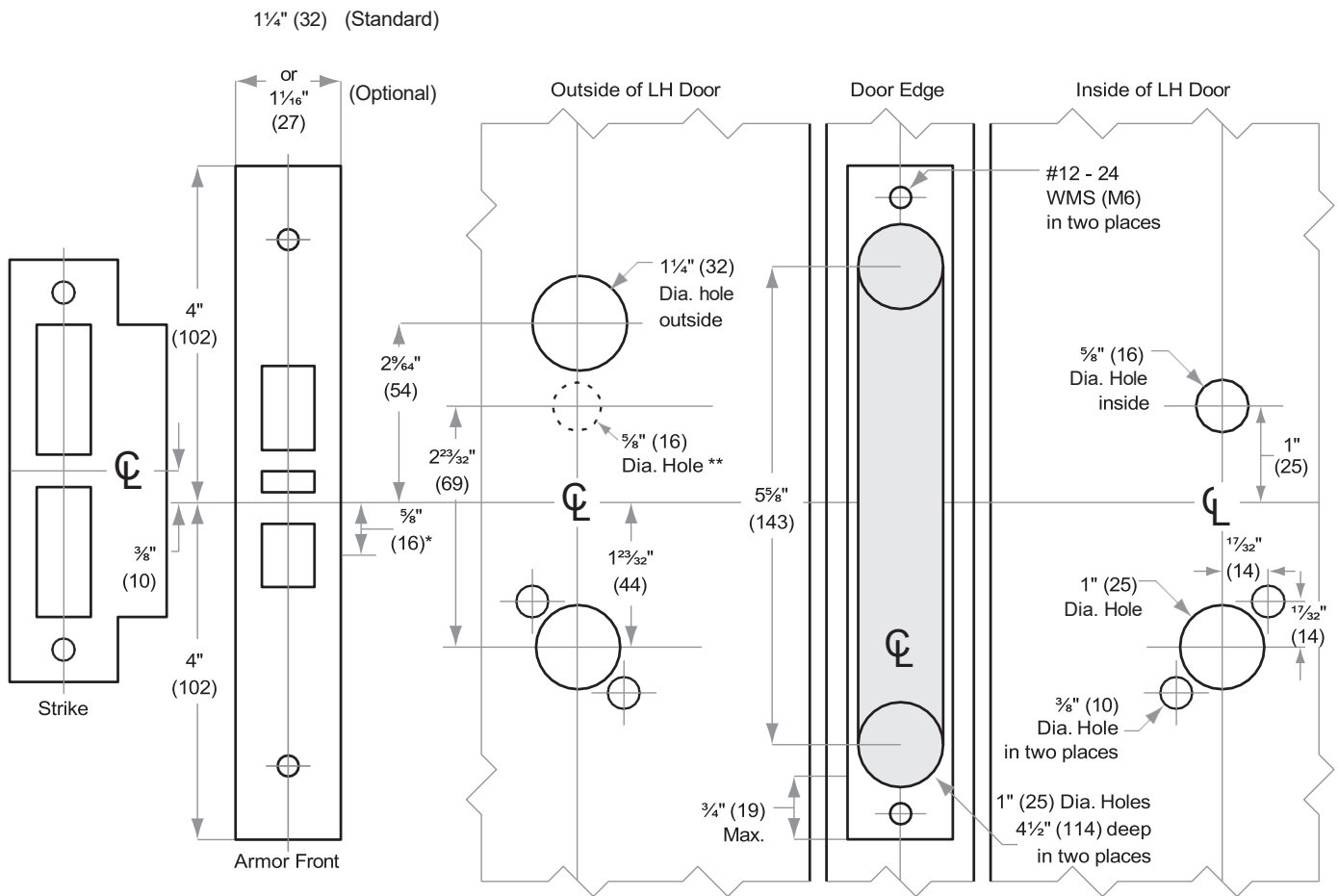

* Centerline of Armor Front to Centerline of Latch dimension

** Additional preparation for L283-721, L283-722, L283-723, L283-724

Dimensions shown in parentheses () are in millimeters.

DRAWING IS NOT TO SCALE!

Customer service: 877-671-7011

Door preparation
template

L/LV/LM/LMV-Series

ALLEGION™

Model L/LV/LM/LMV9050, L/LV/LM/LMV9056, L/LV9453,
L/LV9456, L9473, L/LV9480, L/LV9485, LM/LMV9350,
LM/LMV9356

Door Type: Metal, flat or beveled
Trim: Rose

This template should not be used for HSLR trim. Use template L966 for HSLR trim.

For Case and Strike dimensions, see Template L1

Left Hand (LH) Door Shown

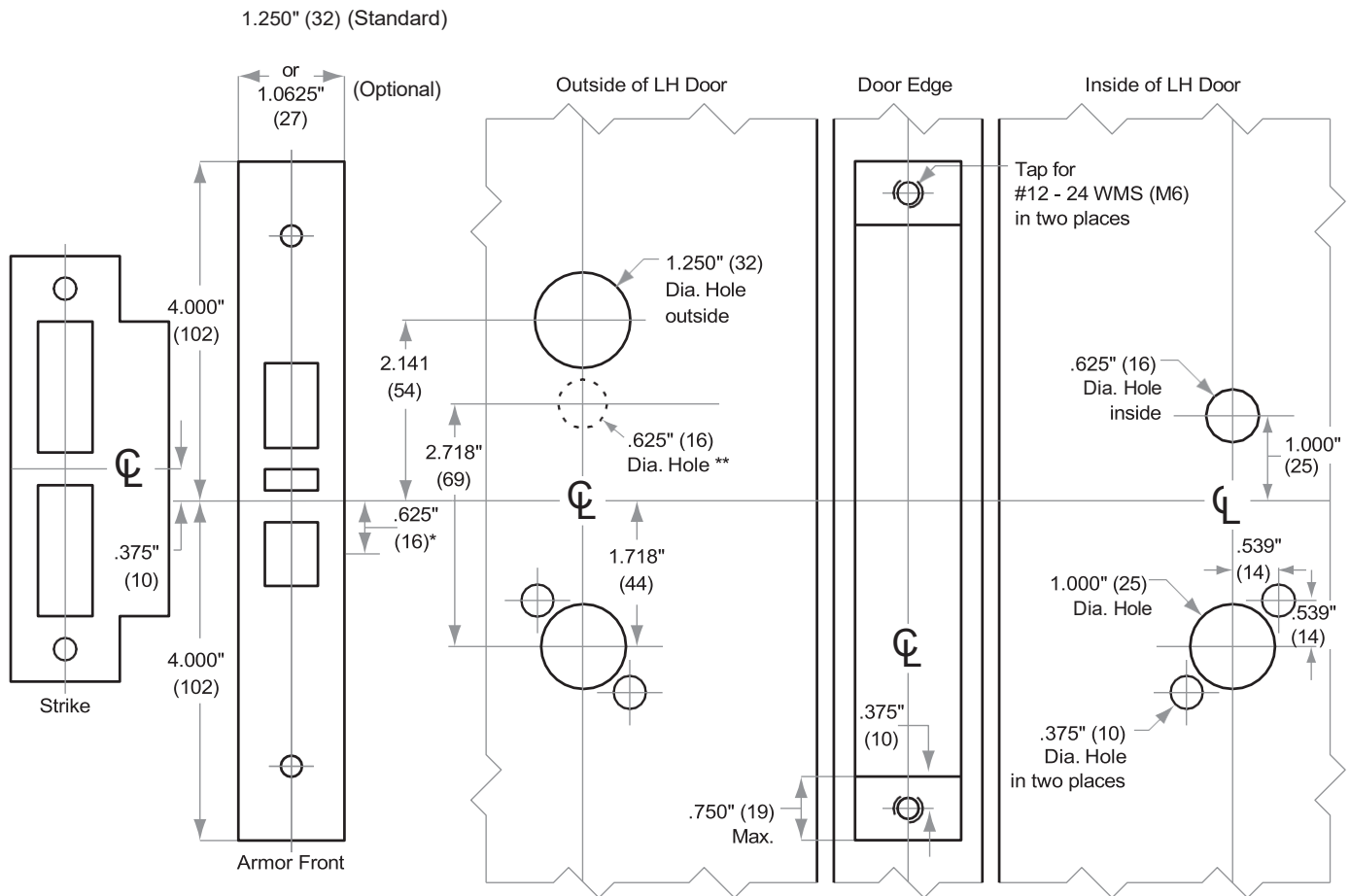

* Centerline of Armor Front to Centerline of Latch dimension
** Additional preparation for L283-721, L283-722, L283-723, L283-724

Door preparation
template

L/LV/LM/LMV-Series

Model L9010, L9110

ALLEGION™

Door Type: Wood or composite, flat or beveled
Trim: Escutcheon

This template should not be used for HSLR trim. Use template L965 for HSLR trim.

For Case and Strike dimensions, see Template L1

Left Hand (LH) Door Shown

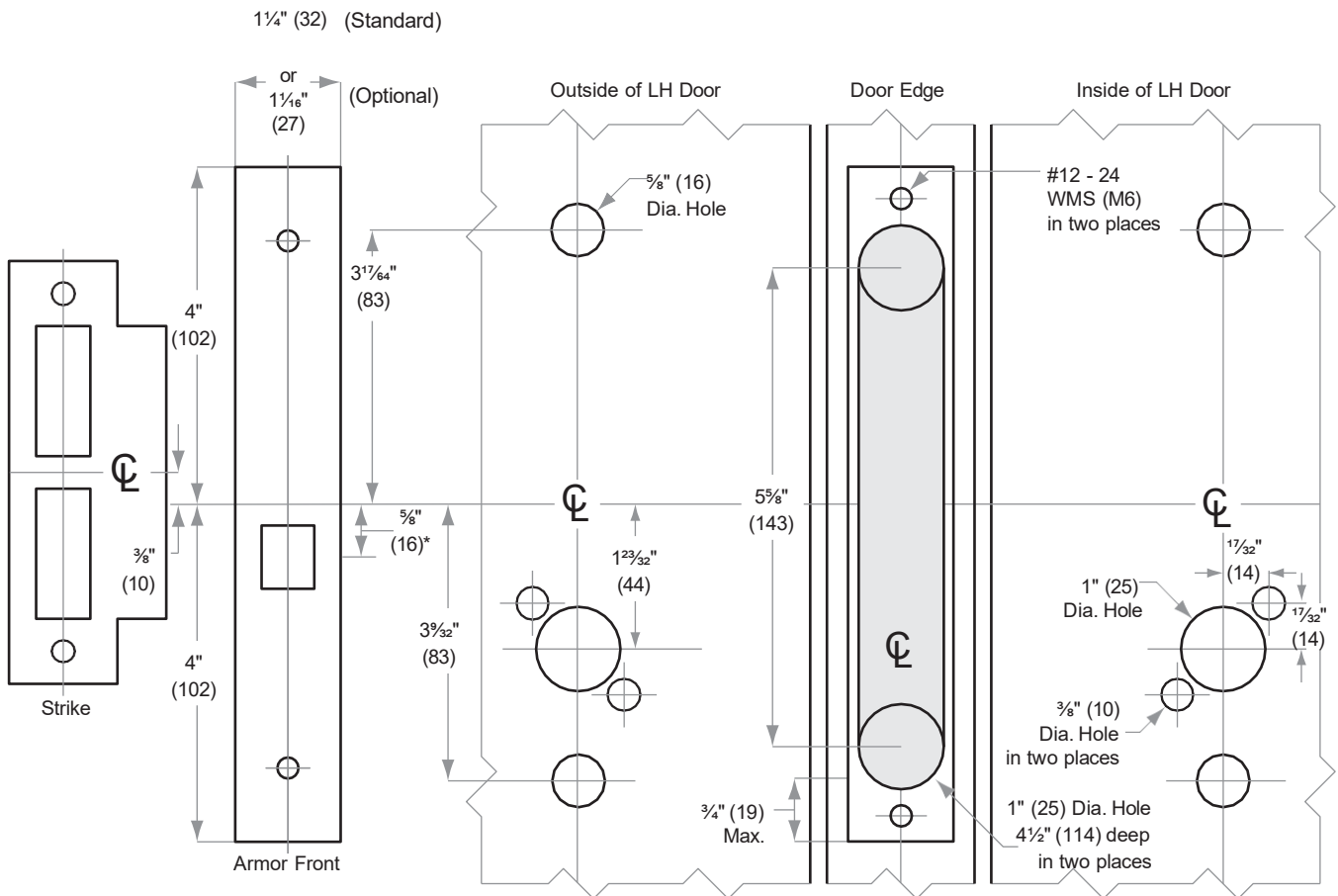

*Centerline of Armor Front to Centerline of Latch dimension

Dimensions shown in parentheses () are in millimeters.

DRAWING IS NOT TO SCALE!

Customer service: 877-671-7011

Door preparation
template

L/LV/LM/LMV-Series

Model L9010, L9110, LM9310

ALLEGION™

Door Type: Metal, flat or beveled
 Trim: Escutcheon

This template should not be used for HSLR trim. Use template L966 for HSLR trim.

For Case and Strike dimensions, see Template L1

Left Hand (LH) Door Shown

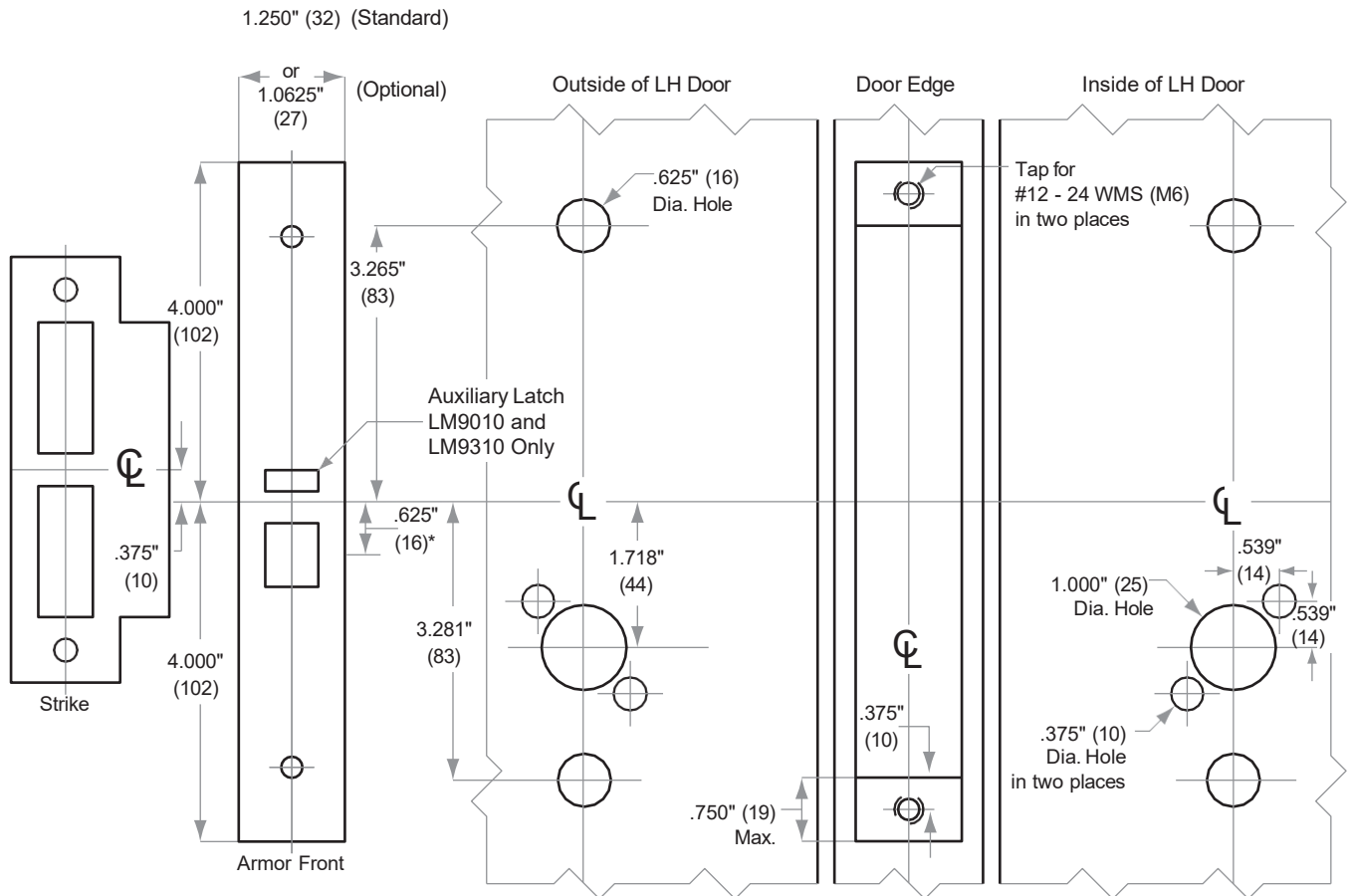

*Centerline of Armor Front to Centerline of Latch dimension

Dimensions shown in parentheses () are in millimeters.

L899 Rev. 12/21

© 2021 Allegion

DRAWING IS NOT TO SCALE!
 Customer service: 877-671-7011

**We can help you find the
correct guide for**

Door preparation template

L899

L/LV/LM/LMV-Series

Model L/LV9040, L/LV9440, L/LV9444

ALLEGION™

Door Type: Wood or composite, flat or beveled

Trim: Escutcheon

This template should not be used for HSLR trim. Use template L965 for HSLR trim.

For Case and Strike dimensions, see Template L1

Left Hand (LH) Door Shown

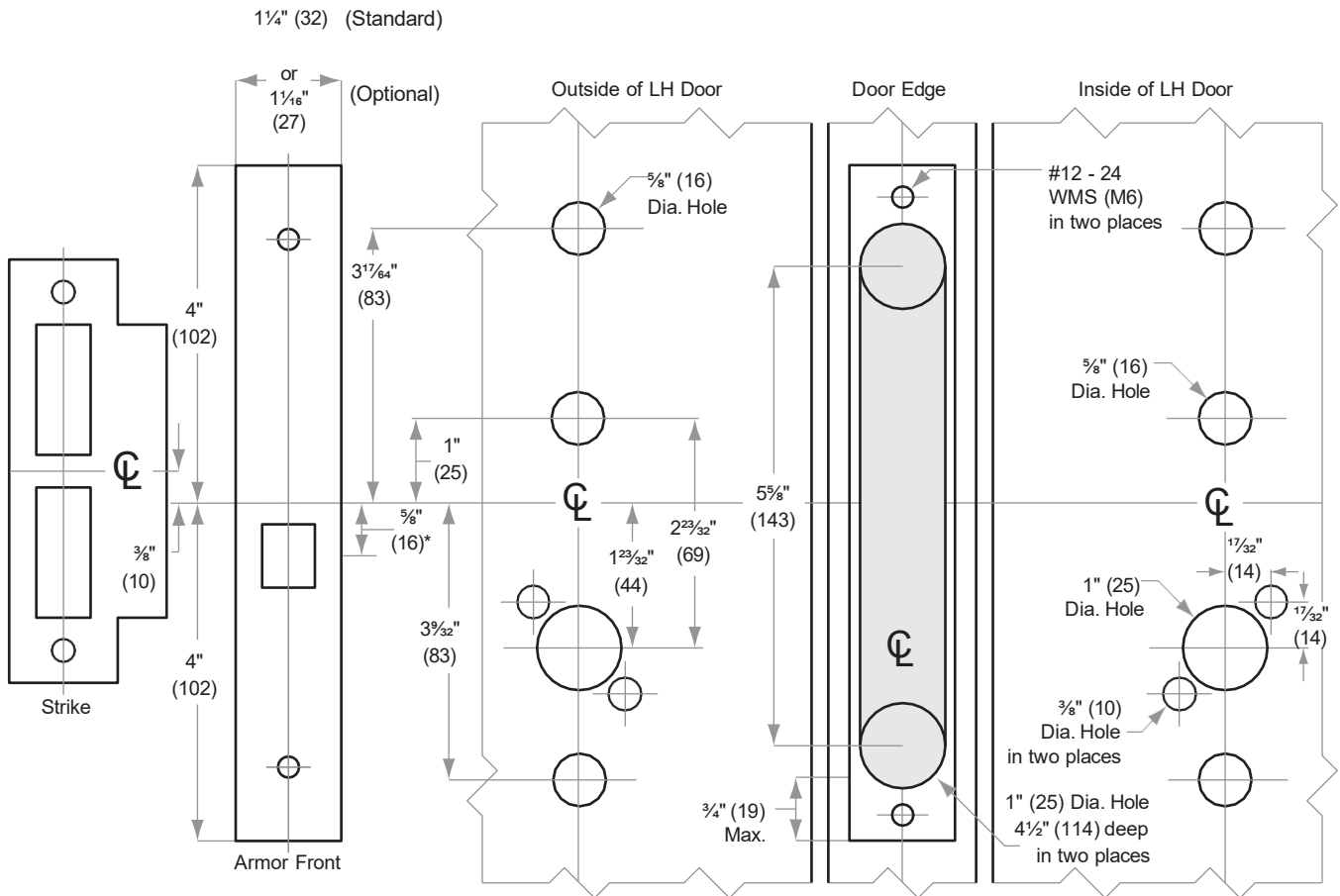

*Centerline of Armor Front to Centerline of Latch dimension

L900 Rev. 12/21

Dimensions shown in parentheses () are in millimeters.

© 2021 Allegion

DRAWING IS NOT TO SCALE!
Customer service: 877-671-7011

**We can help you find the
correct guide for**

Door preparation template

L900

L/LV/LM/LMV-Series

Model L/LV9040, L/LV9440, L/LV9444

Door Type: Metal, flat or beveled

Trim: Escutcheon

This template should not be used for HSLR trim. Use template L966 for HSLR trim.

For Case and Strike dimensions, see Template L1

Left Hand (LH) Door Shown

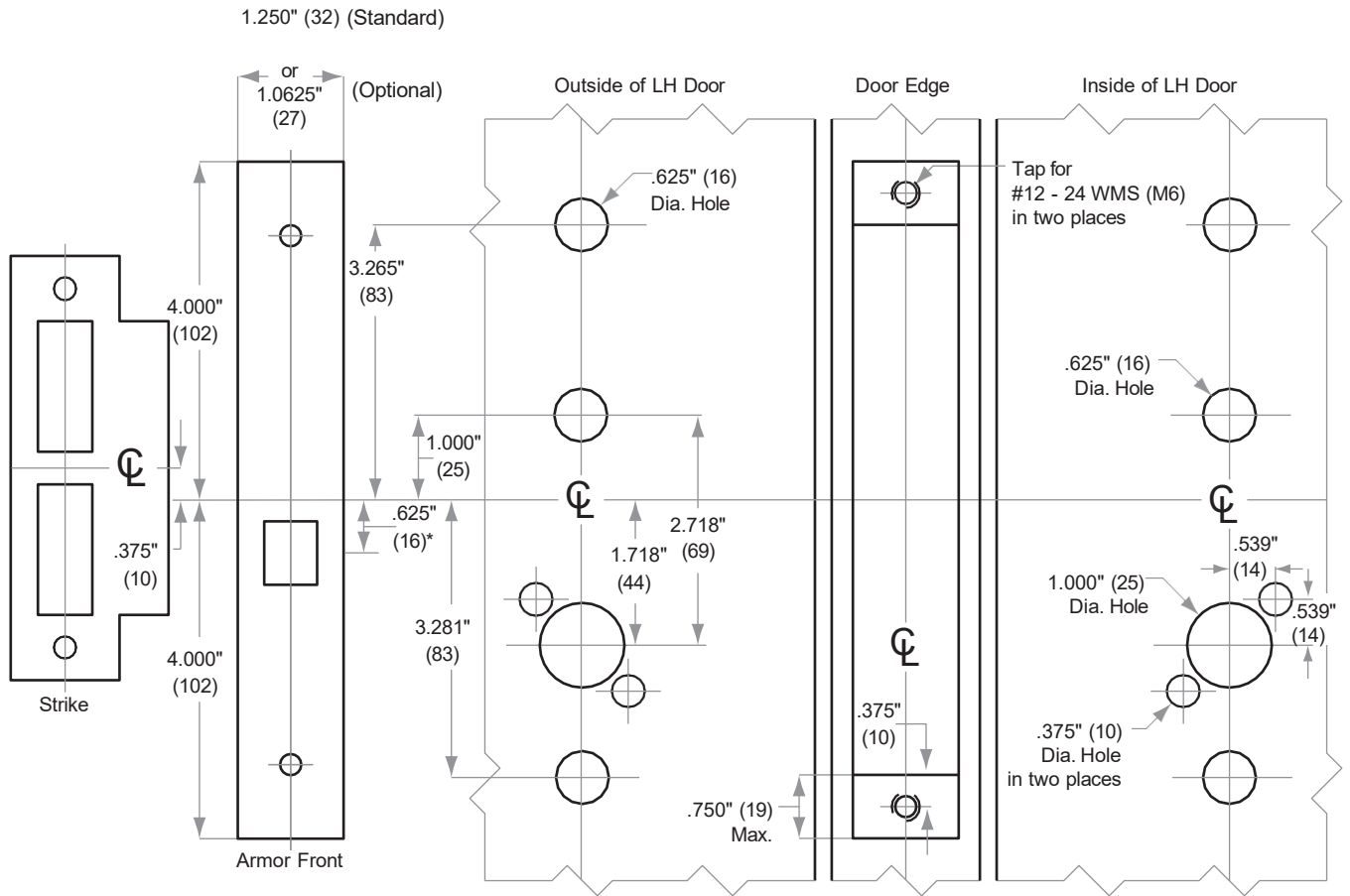

*Centerline of Armor Front to Centerline of Latch dimension

**We can help you find the
correct guide for**

Door preparation template

L901

L/LV/LM/LMV-Series

Model L9460, L9462, L9463, L9464

ALLEGION™

Door Type: Wood or composite, flat or beveled
 Trim: Deadbolt

For Case dimensions, see Template L1

FUNCTION	DRILL HOLE		
	1	2	3
L9460	X		X
L9462, L9463	X	X	***
L9464	X		

Left Hand (LH) Door Shown

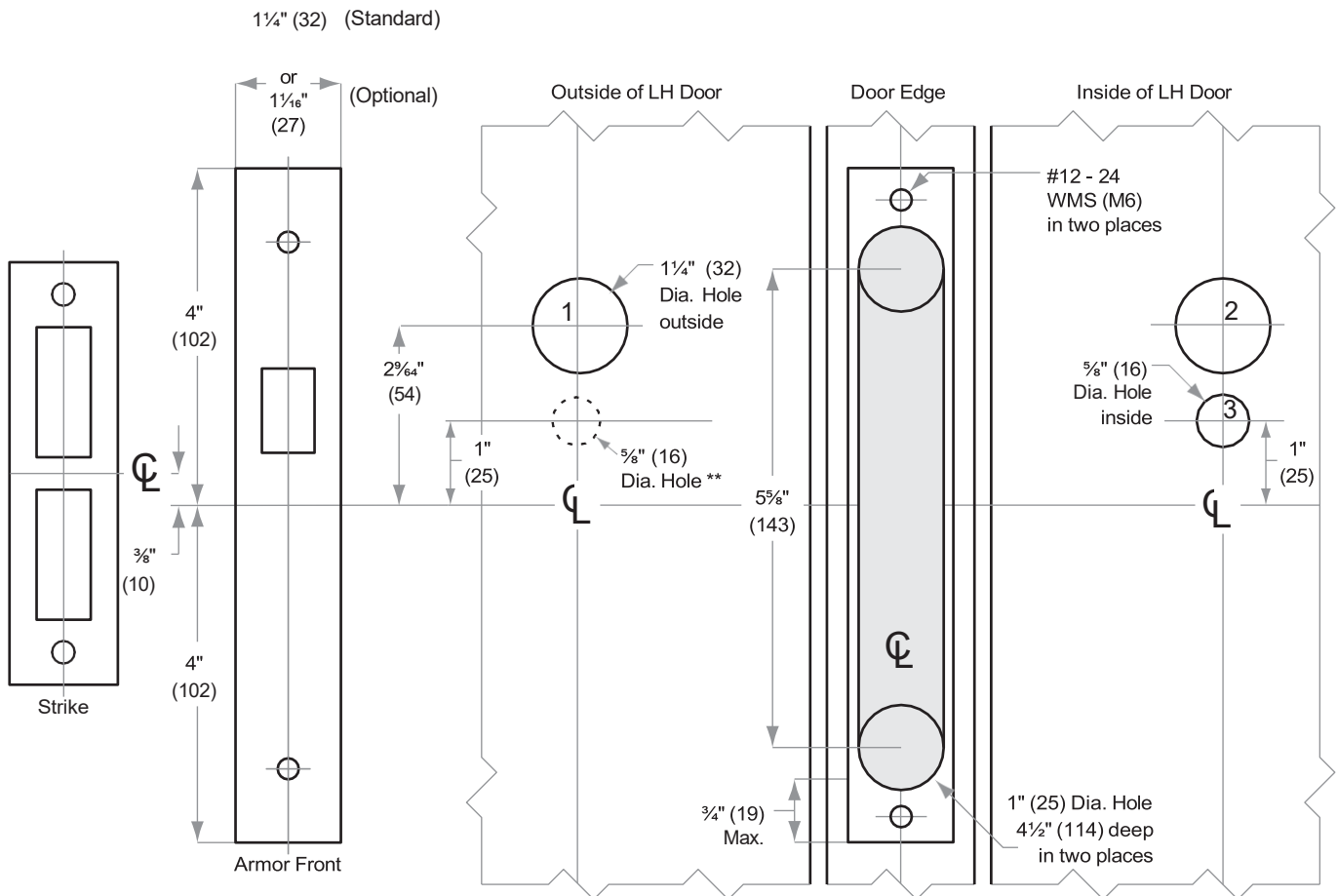

- * Centerline of Armor Front to Centerline of Latch dimension
- ** Additional preparation for L283-721, L283-722, L283-723, L283-724
- *** Additional preparation for L283-711, L283-712, L283-713, L283-714

L902 Rev. 12/21

Dimensions shown in parentheses () are in millimeters.

DRAWING IS NOT TO SCALE!
 Customer service: 877-671-7011

**We can help you find the
correct guide for**

Door preparation template

L902

L/LV/LM/LMV-Series

Model L9460, L9462, L9463, L9464

Door Type: Metal, flat or beveled
 Trim: Deadbolt

For Case and Strike dimensions, see Template L1

FUNCTION	DRILL HOLE		
	1	2	3
L9460	X		X
L9462, L9463	X	X	***
L9464	X		

Left Hand (LH) Door Shown

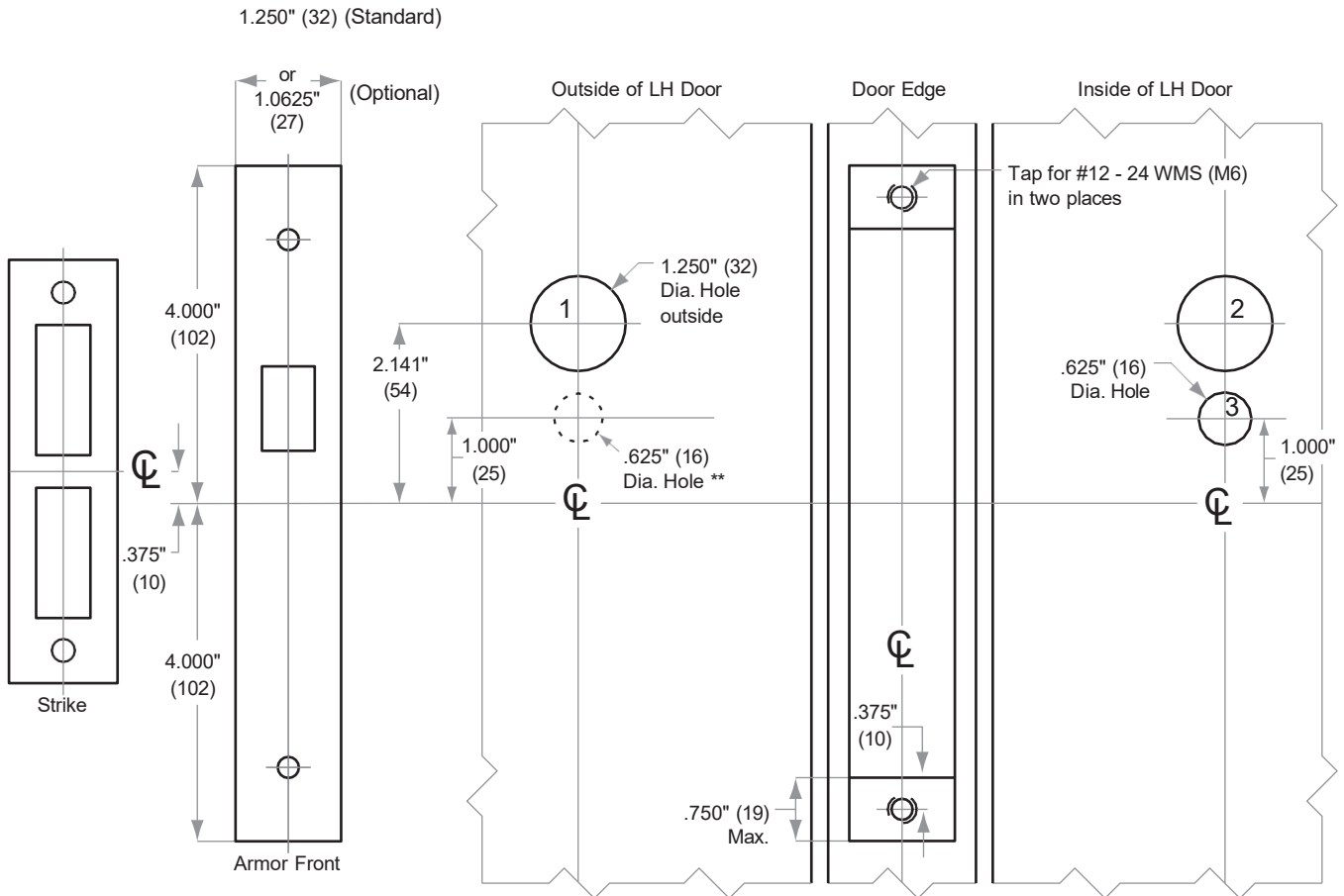

* Centerline of Armor Front to Centerline of Latch dimension
 ** Additional preparation for L283-721, L283-722, L283-723, L283-724
 *** Additional preparation for L283-711, L283-712, L283-713, L283-714

L903 Rev. 12/21

Dimensions shown in parentheses () are in millimeters.

© 2021 Allegion

DRAWING IS NOT TO SCALE!
 Customer service: 877-671-7011

**We can help you find the
correct guide for**

Door preparation template

L903

L/LV/LM/LMV-Series

Model L283-150

ALLEGION™

Door Type: Any
Trim: Mounting plate, rose, one side only

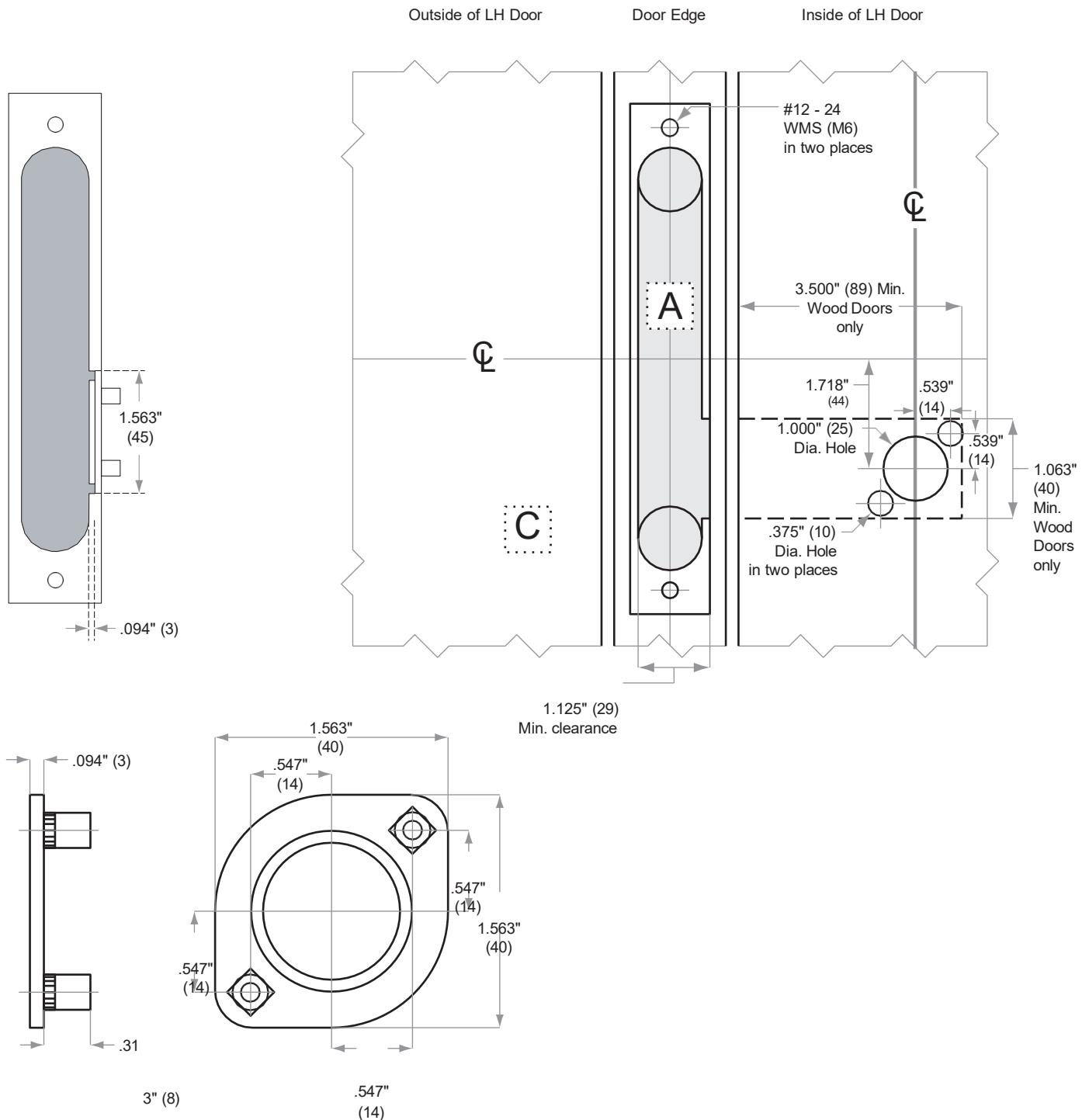

Dimensions shown in
parentheses () are in millimeters.

© 2021 Allegion
L904 Rev. 12/21

DRAWING IS NOT TO SCALE!
Customer service: 877-671-7011
We can help you find the correct guide
for

Door preparation template

L904

L/LV/LM/LMV-Series

ALLEGION™

Model L/LV9070, L/LV9076, L/LV9080,
L/LV9080EL/EU, L9465

Door Type: Wood or composite, flat or beveled

Trim: Rose

This template should not be used for HSLR trim. Use template L965 for HSLR trim.

**For Case and Strike dimensions, see Template L1
Refer to Template L1 for information to prepare
the door for wire routing**

Left Hand (LH) Door Shown

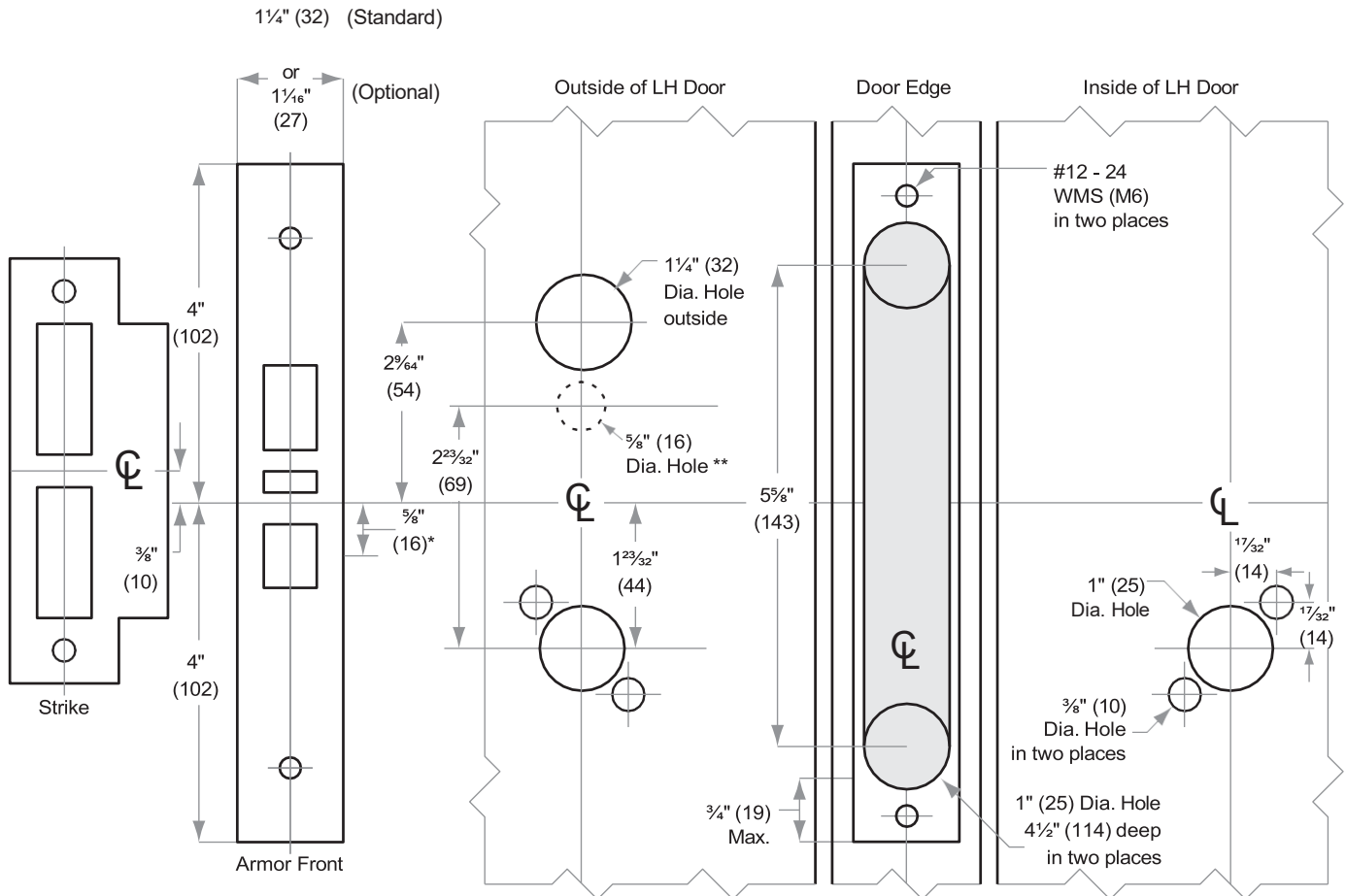

Dimensions shown in parentheses () are in millimeters.

L905 Rev. 12/21

**DRAWING IS NOT TO SCALE!
Customer service: 877-671-7011**

**We can help you find the
correct guide for**

Door preparation template

L905

L/LV/LM/LMV-Series

ALLEGION™

Model L/LV9070, L/LV9076, L/LV9080,
L/LV9080EL/EU, L9465, LM/LMV9370, LM/LMV9380

Door Type: Metal, flat or beveled

Trim: Rose

This template should not be used for HSLR trim. Use template L966 for HSLR trim.

**For Case and Strike dimensions, see Template L1
Refer to Template L1 for information to prepare
the door for wire routing**

Left Hand (LH) Door Shown

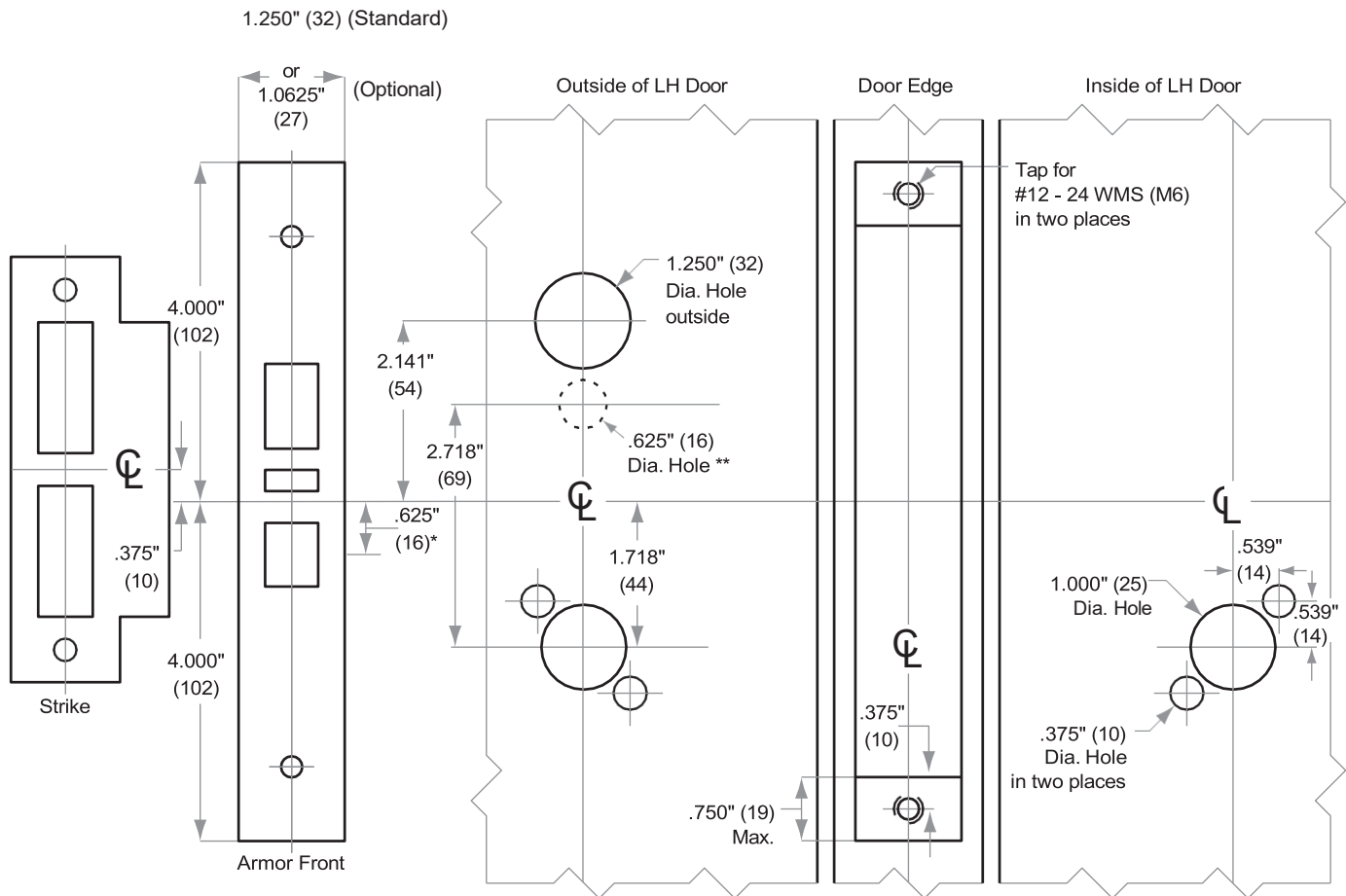

* Centerline of Armor Front to Centerline of Latch dimension

** Additional preparation for L283-721, L283-722, L283-723, L283-724

Dimensions shown in parentheses () are in millimeters.

DRAWING IS NOT TO SCALE!

Customer service: 877-671-7011

Door preparation
template

L/LV/LM/LMV-Series

ALLEGION™

Model L/LV9070, L/LV9076, L/LV9080,
L/LV9080EL/EU, L9465

Door Type: Wood or composite, flat or beveled

Trim: Escutcheon

This template should not be used for HSLR trim. Use template L965 for HSLR trim.

**For Case and Strike dimensions, see Template L1
Refer to Template L1 for information to prepare
the door for wire routing**

Left Hand (LH) Door Shown

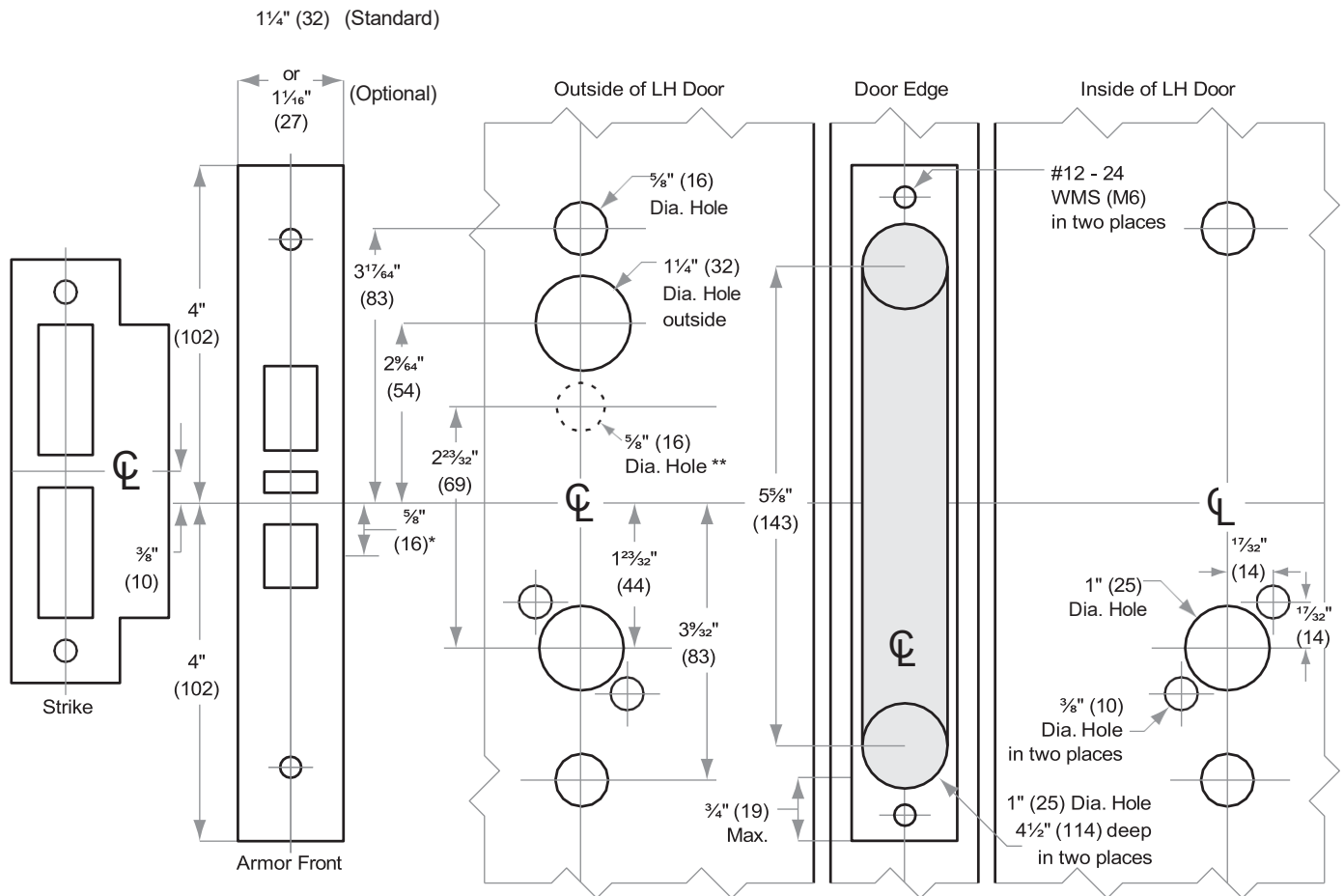

* Centerline of Armor Front to Centerline of Latch dimension

** Additional preparation for L283-721, L283-722, L283-723, L283-724

Dimensions shown in parentheses () are in millimeters.

DRAWING IS NOT TO SCALE!

Customer service: 877-671-7011

Door preparation
template

L/LV/LM/LMV-Series

ALLEGION™

Model L/LV9070, L/LV9076, L/LV9080, L/LV9080EL/EU,
L9465, LM/LMV9370, LM/LMV9380

Door Type: Metal, flat or beveled

Trim: Escutcheon

This template should not be used for HSLR trim. Use template L966 for HSLR trim.

For Case and Strike dimensions, see Template L1
Refer to Template L1 for information to prepare
the door for wire routing

Left Hand (LH) Door Shown

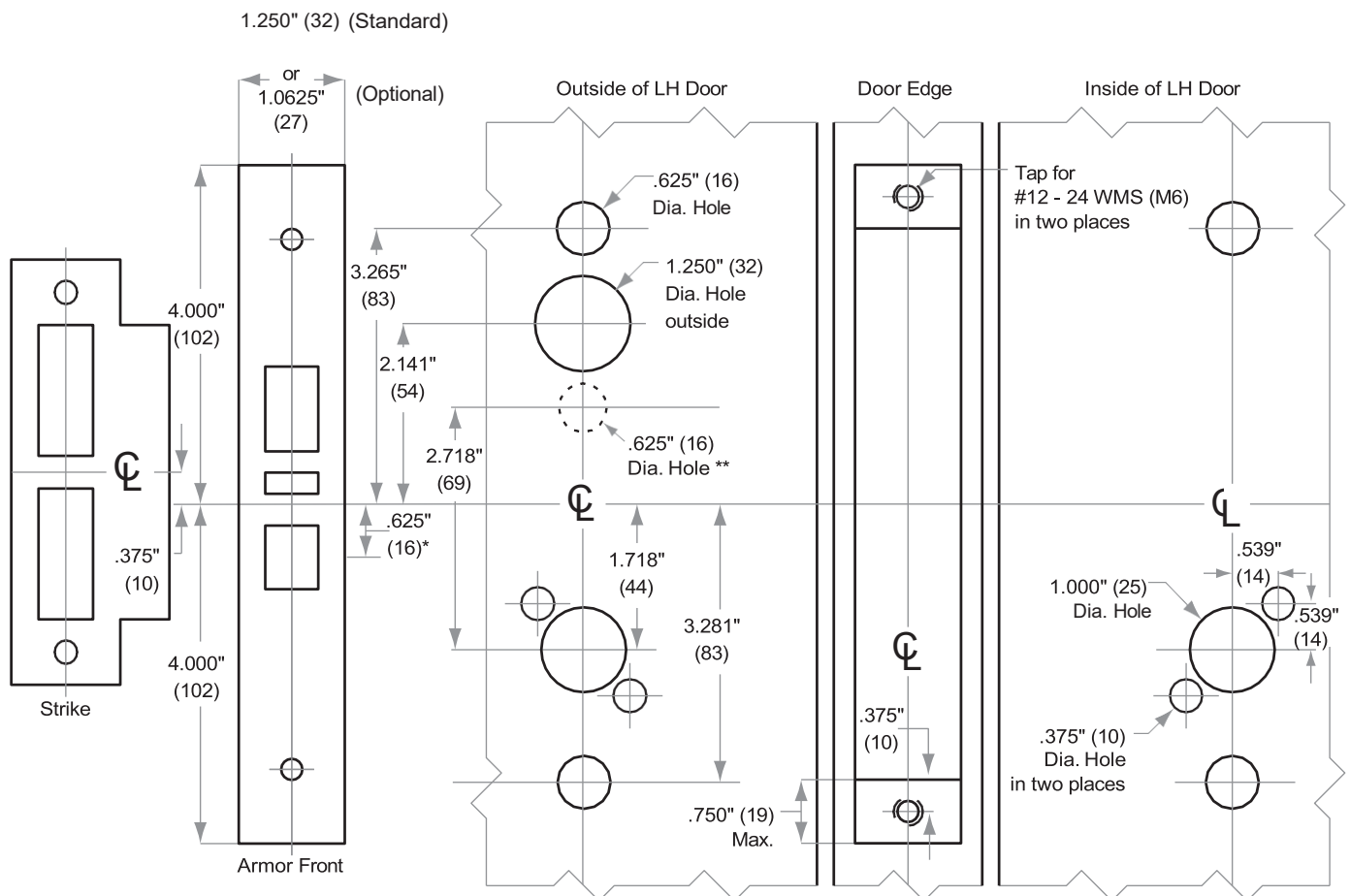

* Centerline of Armor Front to Centerline of Latch dimension

** Additional preparation for L283-721, L283-722, L283-723, L283-724

Dimensions shown in parentheses () are in millimeters.

DRAWING IS NOT TO SCALE!

Customer service: 877-671-7011

Door preparation
template

Dimensions shown in
parentheses () are in millimeters.

© 2021 Allegion
L909 Rev. 12/21

DRAWING IS NOT TO SCALE!
Customer service: 877-671-7011
We can help you find the correct guide
for

Door preparation template

L909

L/LV/LM/LMV-Series

Model L460, L462, L463, L464, L480, L496

ALLEGION™

Door Type: Metal, flat or beveled

Trim: Small case deadbolt

For case and strike dimensions, see Template L2.

FUNCTION	DRILL			
	1	2	3	4
L460	X		X	**
L462, L463	X	X	***	**
L464	X			**
L480			X	
L496*	X		X	X

* Drill through-hole from 3 to 4 for L496

** Additional preparation for L283-721, L283-722, L283-723, L283-724

*** Additional preparation for L283-711, L283-712, L283-713, L283-714

Left Hand (LH) Door Shown

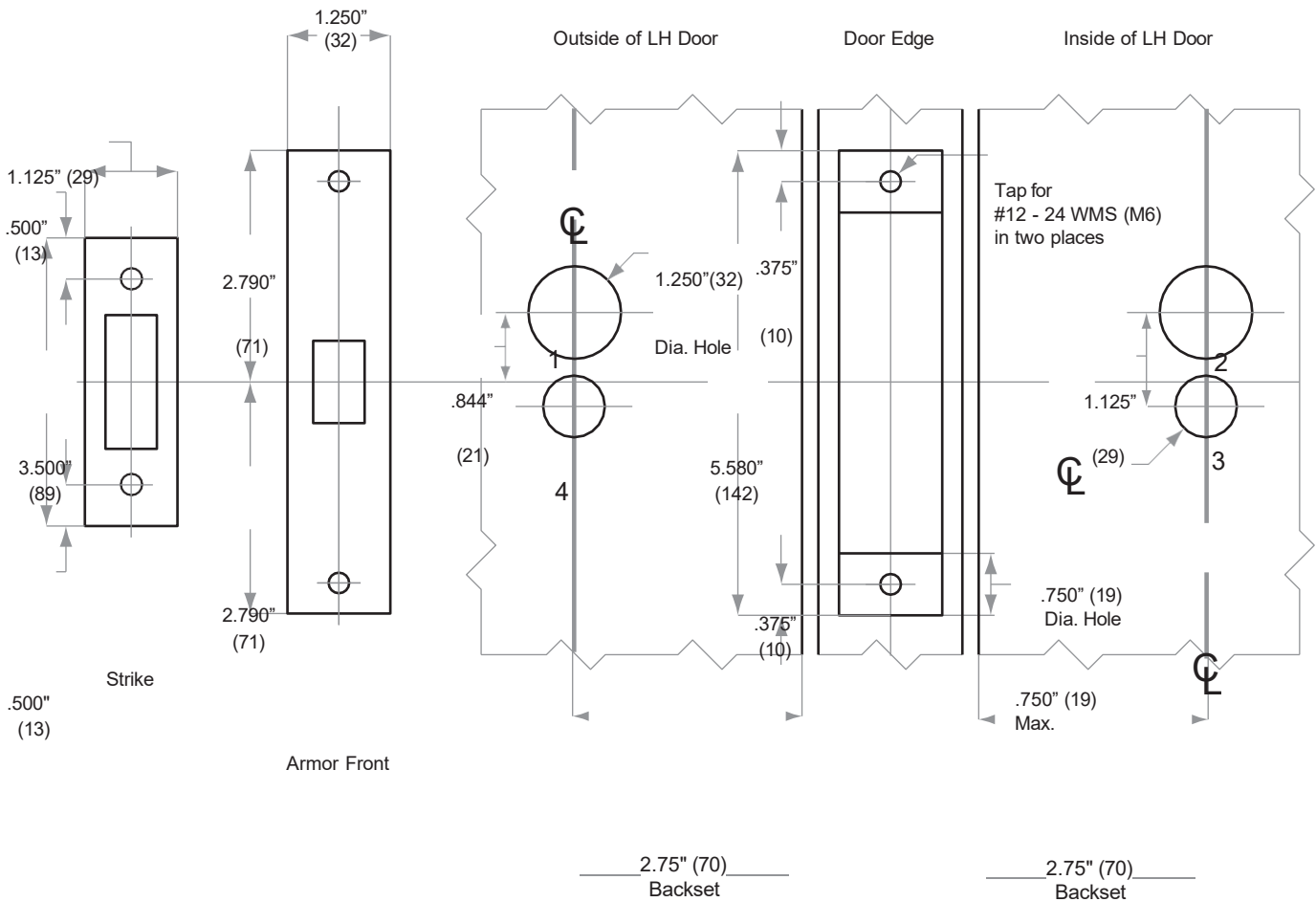

Dimensions shown in parentheses () are in millimeters.

© 2021 Allegion
L910 Rev. 12/21

DRAWING IS NOT TO SCALE!
Customer service: 877-671-7011
**We can help you find the correct guide
for**

Door preparation template

L910

L/LV/LM/LMV-Series

Model L9412

ALLEGION™

Door Type: Wood or composite, flat or beveled
Trim: Escutcheon

For Case and Strike dimensions, see Template L1

Left Hand (LH) Door Shown

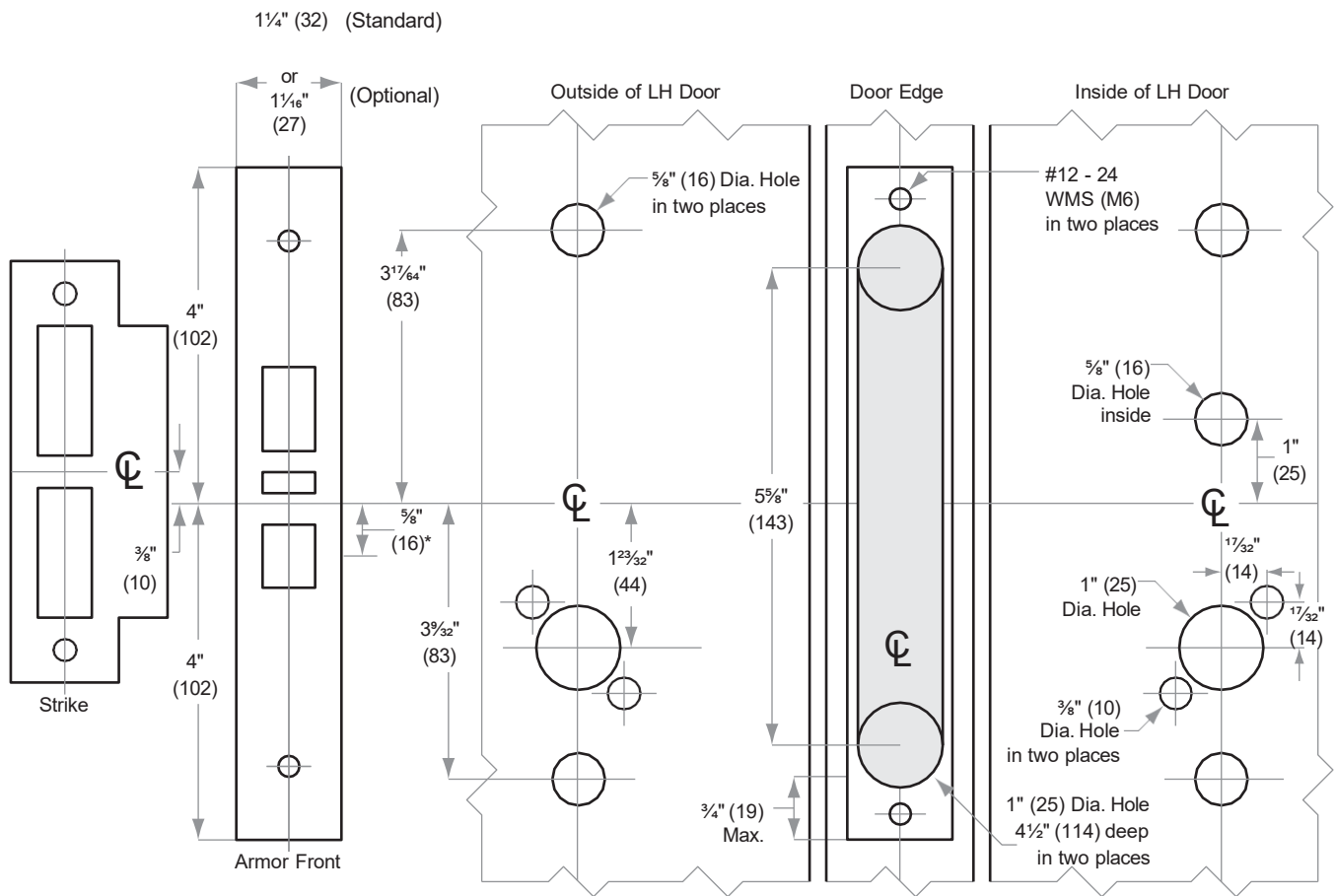

*Centerline of Armor Front to Centerline of Latch dimension

L911 Rev. 12/21

Dimensions shown in parentheses () are in millimeters.

© 2021 Allegion

DRAWING IS NOT TO SCALE!
Customer service: 877-671-7011

**We can help you find the
correct guide for**

Door preparation template

L911

L/LV/LM/LMV-Series

Model L9412

ALLEGION™

Door Type: Metal, flat or beveled

Trim: Escutcheon

For Case and Strike dimensions, see Template L1

Left Hand (LH) Door Shown

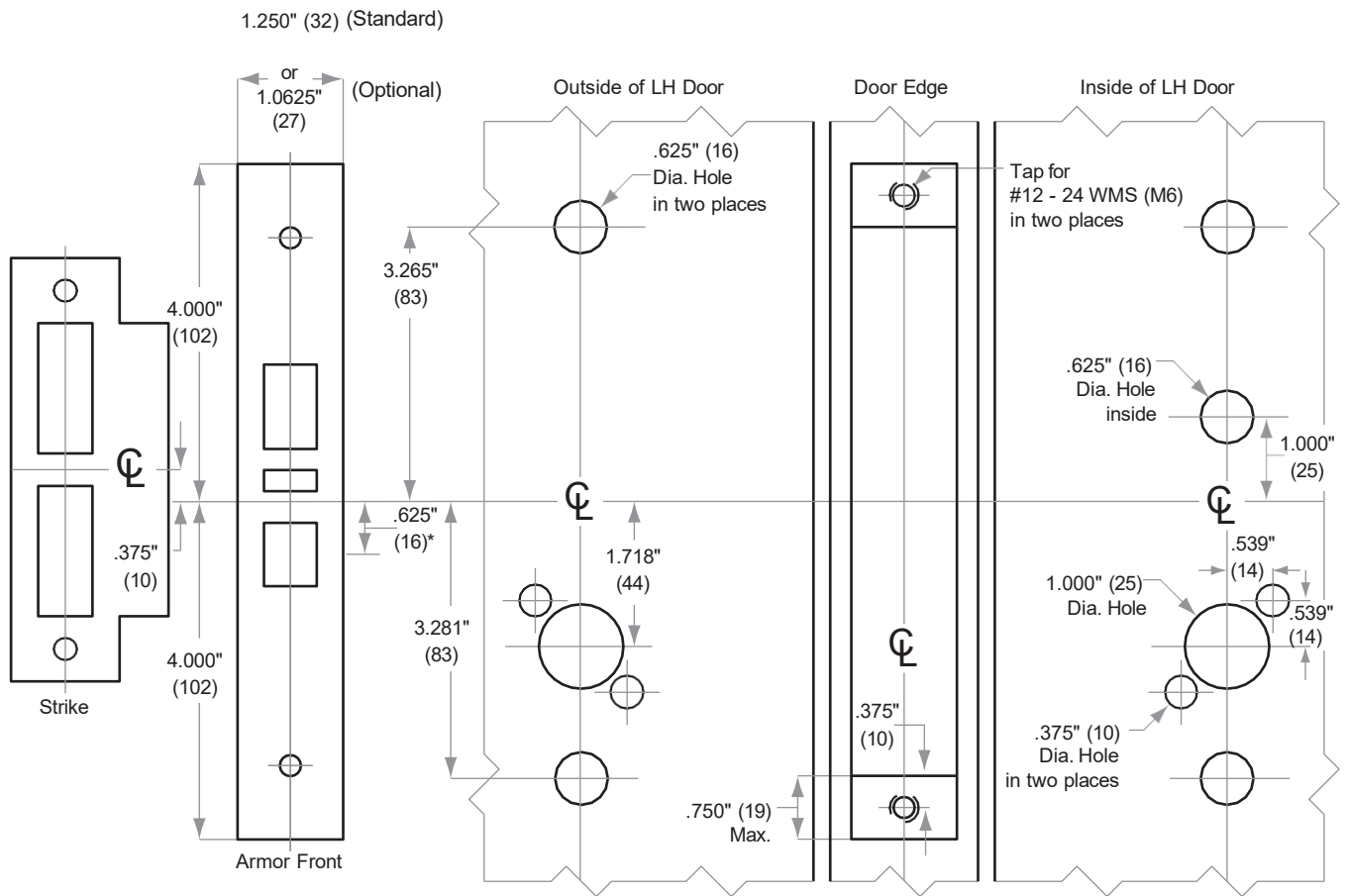

*Centerline of Armor Front to Centerline of Latch dimension

Dimensions shown in parentheses () are in millimeters.

L912 Rev. 12/21

DRAWING IS NOT TO SCALE!
Customer service: 877-671-7011

© 2021 Allegion

**We can help you find the
correct guide for**

Door preparation template

L912

L/LV/LM/LMV-Series

Models L9090, L9091 Electrified Locks

ALLEGION™

Door Type: Metal, flat or beveled
 Trim: Escutcheon

**For Case and Strike dimensions, see Template L1
 Refer to Template L1 (revised October 2014 or
 later) for information to prepare the door for
 wire routing**

Left Hand (LH) Door Shown

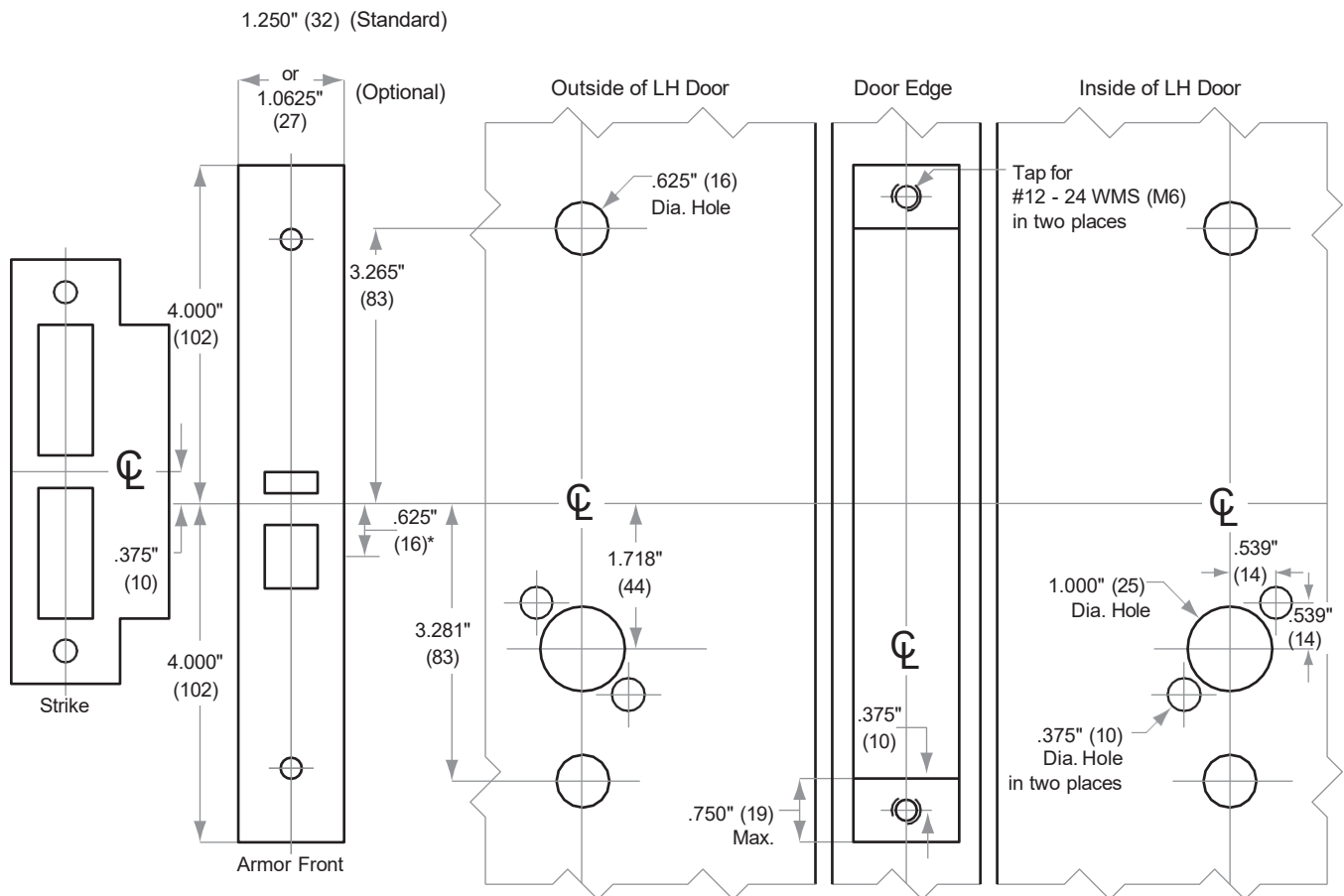

*Centerline of Armor Front to Centerline of Latch dimension

Dimensions shown in parentheses () are in millimeters.

L915 Rev. 12/21

© 2021 Allegion

DRAWING IS NOT TO SCALE!
Customer service: 877-671-7011

**We can help you find the
correct guide for**

Door preparation template

L915

L/LV/LM/LMV-Series

Models L9090, L9091 Electrified Locks

ALLEGION™

Door Type: Metal, flat or beveled

Trim: Rose

**For Case and Strike dimensions, see Template L1
Refer to Template L1 (revised October 2014 or
later) for information to prepare the door for
wire routing**

Left Hand (LH) Door Shown

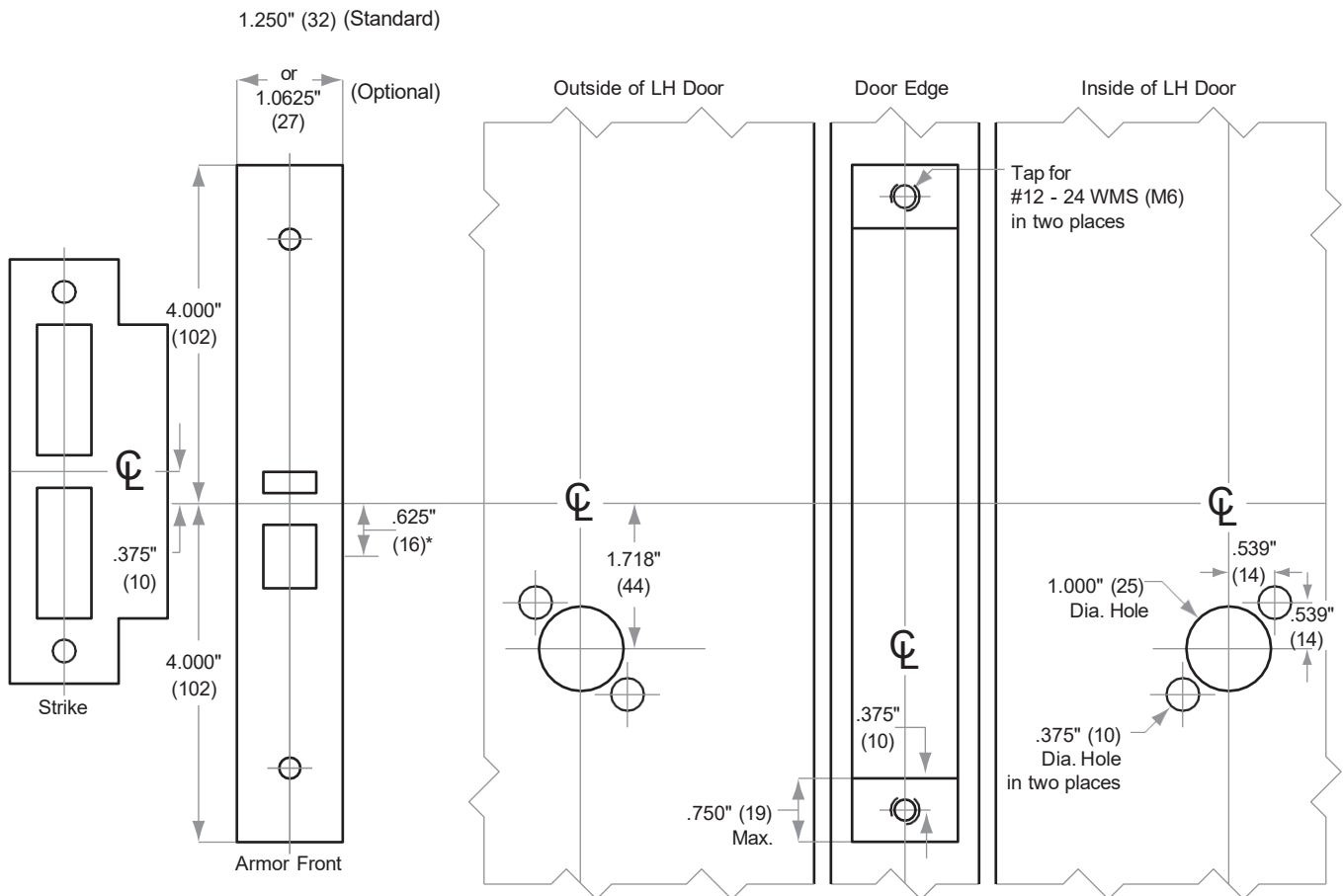

*Centerline of Armor Front to Centerline of Latch dimension

Dimensions shown in parentheses () are in millimeters.

DRAWING IS NOT TO SCALE!

Customer service: 877-671-7011

Door preparation
template

Door preparation
template

L/LV/LM/LMV-Series

Models L9090, L9091 Electrified Locks

ALLEGION™

Door Type: Wood or composite, flat or beveled
 Trim: Rose

**For Case and Strike dimensions, see Template L1
 Refer to Template L1 (revised October 2014 or
 later) for information to prepare the door for
 wire routing**

Left Hand (LH) Door Shown

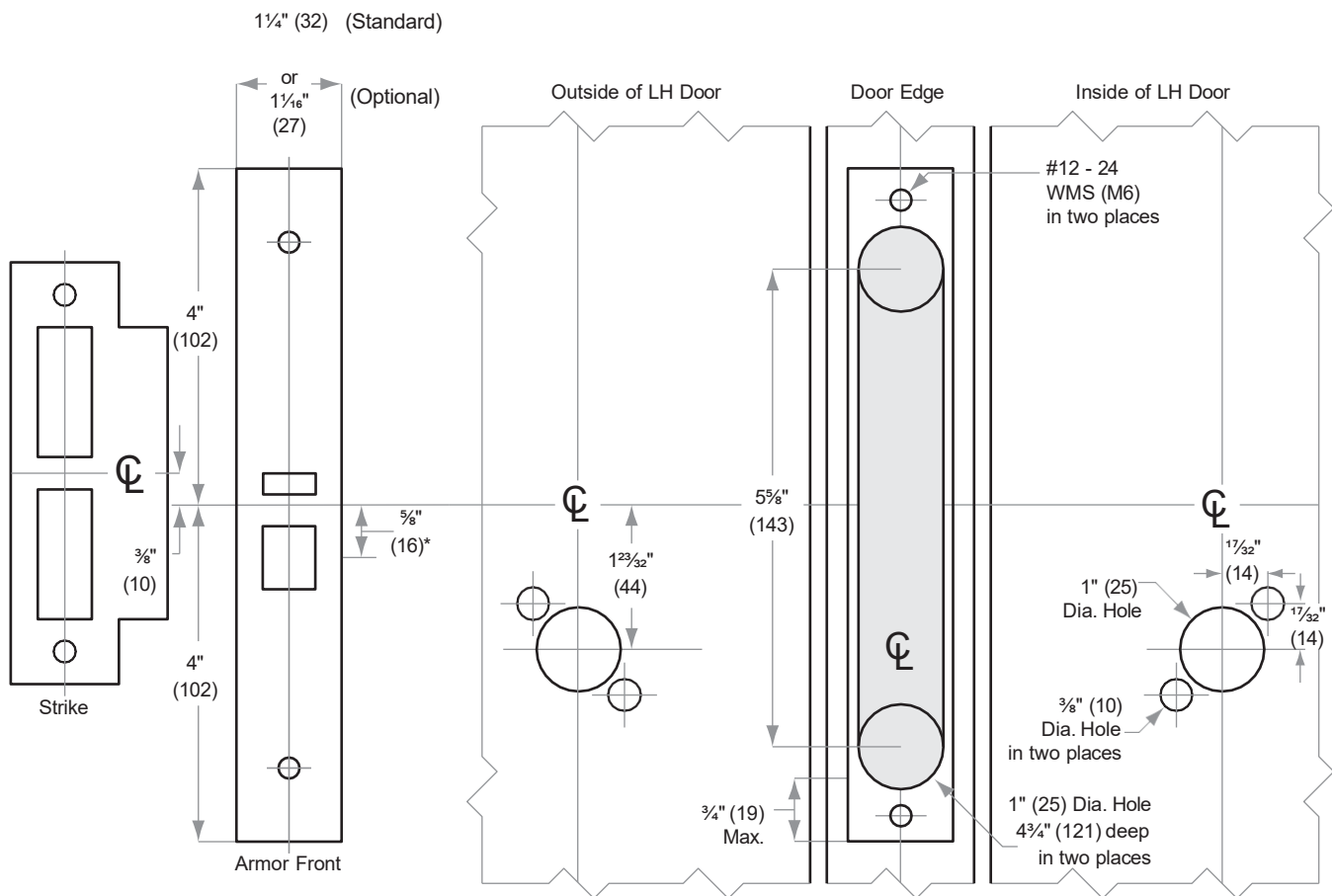

*Centerline of Armor Front to Centerline of Latch dimension

Dimensions shown in parentheses () are in millimeters.

DRAWING IS NOT TO SCALE!

Customer service: 877-671-7011

Door preparation
template

L/LV/LM/LMV-Series

Models L9092, L9093 Electrified Locks

ALLEGION™

Door Type: Metal, flat or beveled
 Trim: Escutcheon

This template should not be used for HSLR trim. Use template L966 for HSLR trim.

**For Case and Strike dimensions, see Template L1
 Refer to Template L1 (revised October 2014 or
 later) for information to prepare the door for
 wire routing**

Left Hand (LH) Door Shown

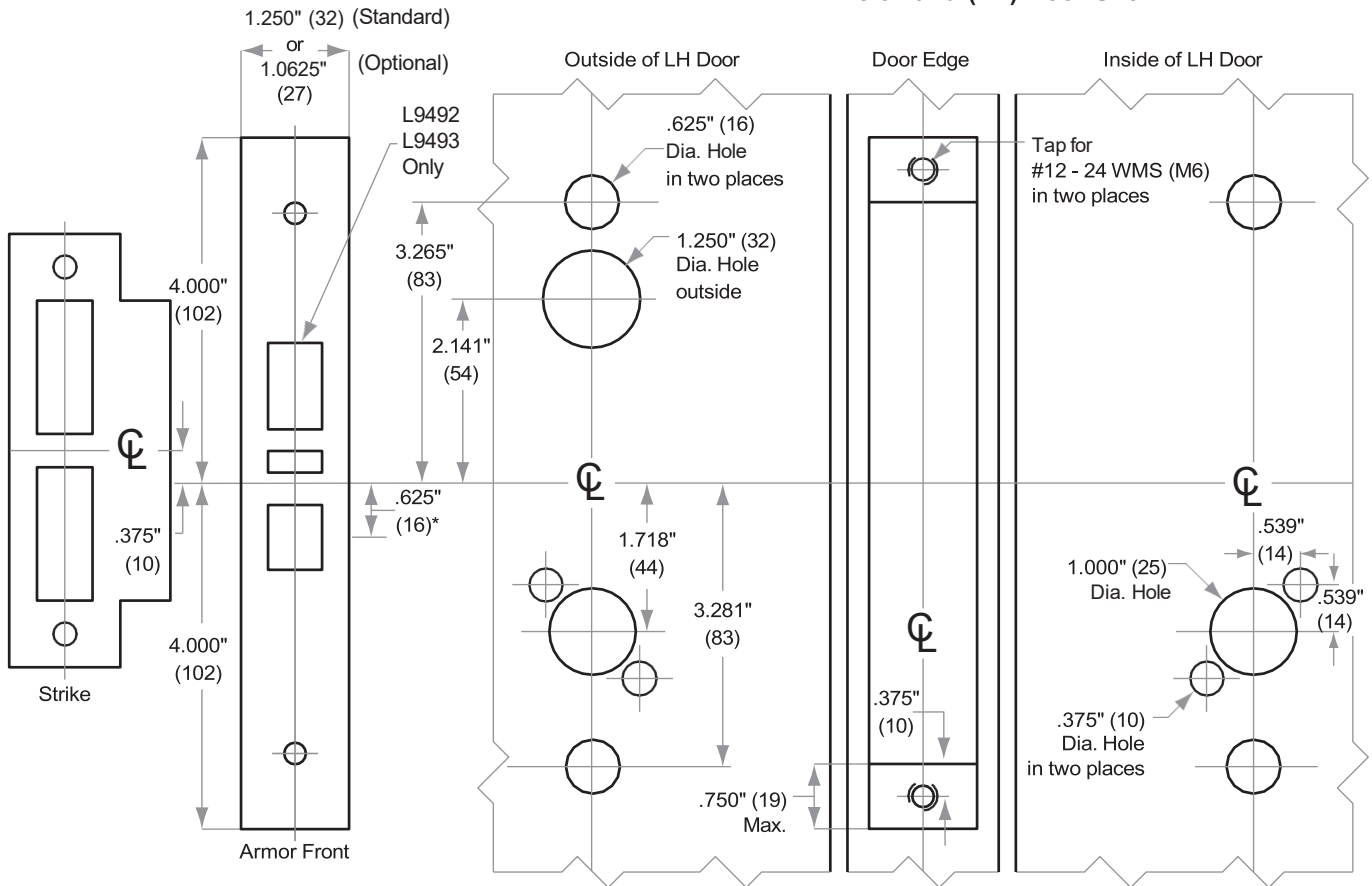

* Centerline of Armor Front to Centerline of Latch dimension

Dimensions shown in parentheses () are in millimeters.

DRAWING IS NOT TO SCALE!
 Customer service: 877-671-

7011

Door preparation
template

L/LV/LM/LMV-Series

Models L9092, L9093 Electrified Locks

ALLEGION™

Door Type: Metal, flat or beveled
 Trim: Rose

This template should not be used for HSLR trim. Use template L966 for HSLR trim.

**For Case and Strike dimensions, see Template L1
 Refer to Template L1 (revised October 2014 or
 later) for information to prepare the door for
 wire routing**

Left Hand (LH) Door Shown

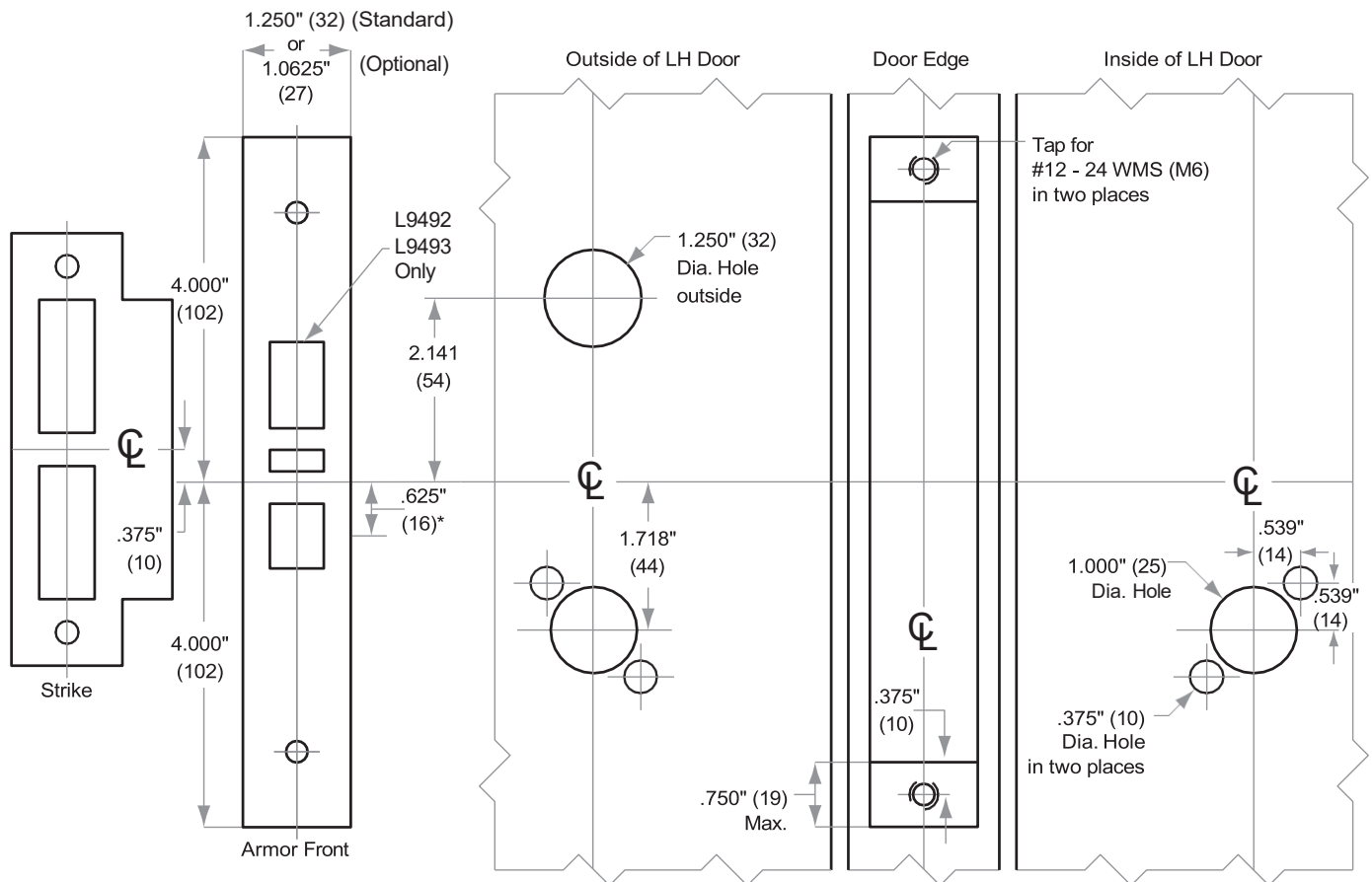

* Centerline of Armor Front to Centerline of Latch dimension

L/LV/LM/LMV-Series

Models L9092, L9093 Locks

ALLEGION™

Door Type: Wood or composite, flat or beveled
Trim: Escutcheon

This template should not be used for HSLR trim. Use template L965 for HSLR trim.

For Case and Strike dimensions, see Template L1
Refer to Template L1 (revised October 2014 or later) for information to prepare the door for wire routing

Left Hand (LH) Door Shown

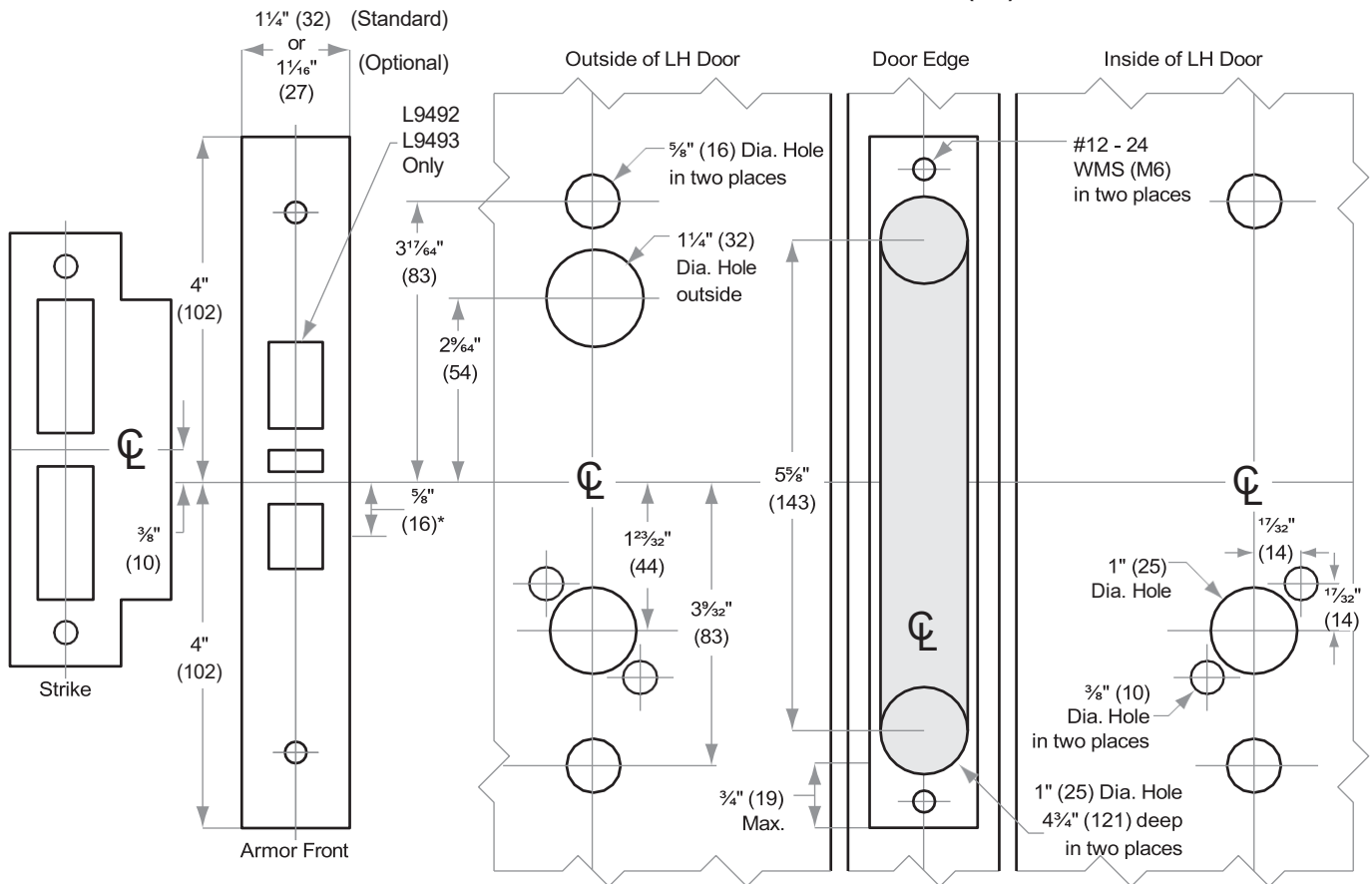

* Centerline of Armor Front to Centerline of Latch dimension

L/LV/LM/LMV-Series

Models L9092, L9093 Electrified Locks

ALLEGION™

Door Type: Wood or composite, flat or beveled
Trim: Rose

This template should not be used for HSLR trim. Use template L965 for HSLR trim.

For Case and Strike dimensions, see Template L1
Refer to Template L1 (revised October 2014 or later) for information to prepare the door for wire routing

Left Hand (LH) Door Shown

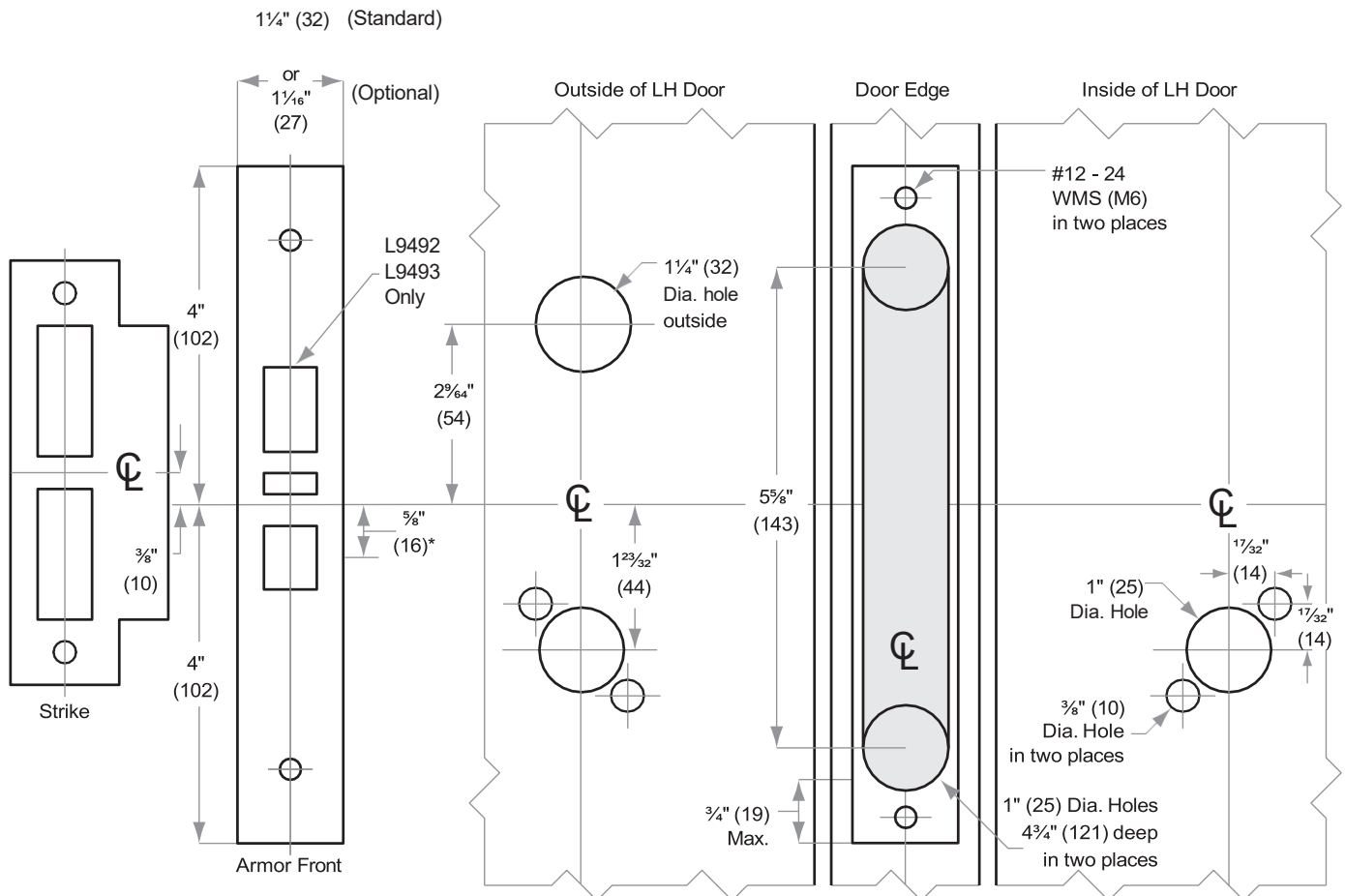

* Centerline of Armor Front to Centerline of Latch dimension

L/LV/LM/LMV-Series

ALLEGION™

Models L9094, L9095, L9494, L9495 Electrified Locks

Door Type: Metal, flat or beveled

Trim: Escutcheon

This template should not be used for HSLR trim. Use template L966 for HSLR trim.

**For Case and Strike dimensions, see Template L1
Refer to Template L1 (revised October 2014 or
later) for information to prepare the door for
wire routing**

Left Hand (LH) Door Shown

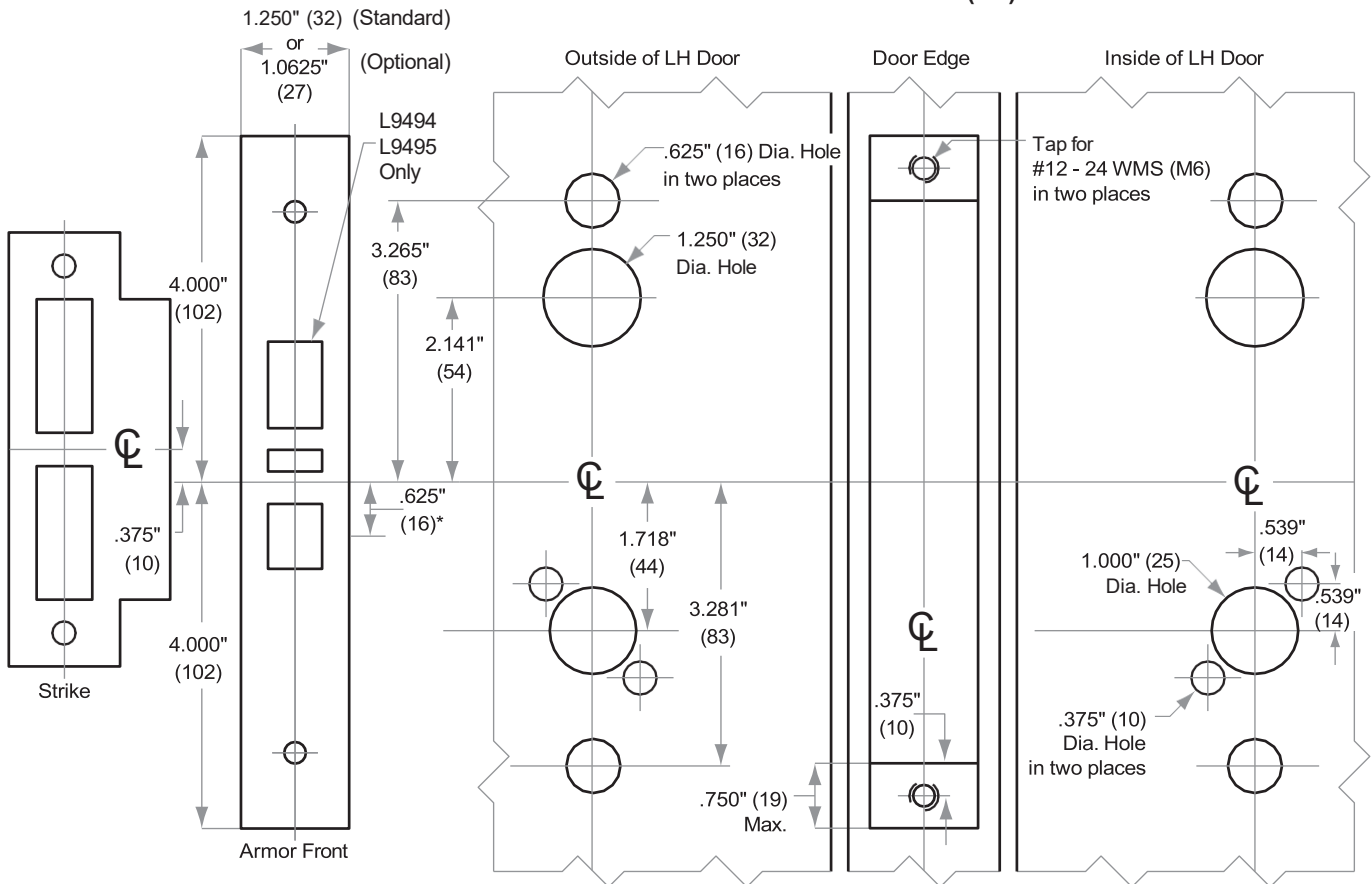

* Centerline of Armor Front to Centerline of Latch dimension

L/LV/LM/LMV-Series

ALLEGION™

Models L9094, L9095, L9494, L9495 Electrified Locks

Door Type: Metal, flat or beveled

Trim: Rose

This template should not be used for HSLR trim. Use template L966 for HSLR trim.

**For Case and Strike dimensions, see Template L1
Refer to Template L1 (revised October 2014 or
later) for information to prepare the door for
wire routing**

Left Hand (LH) Door Shown

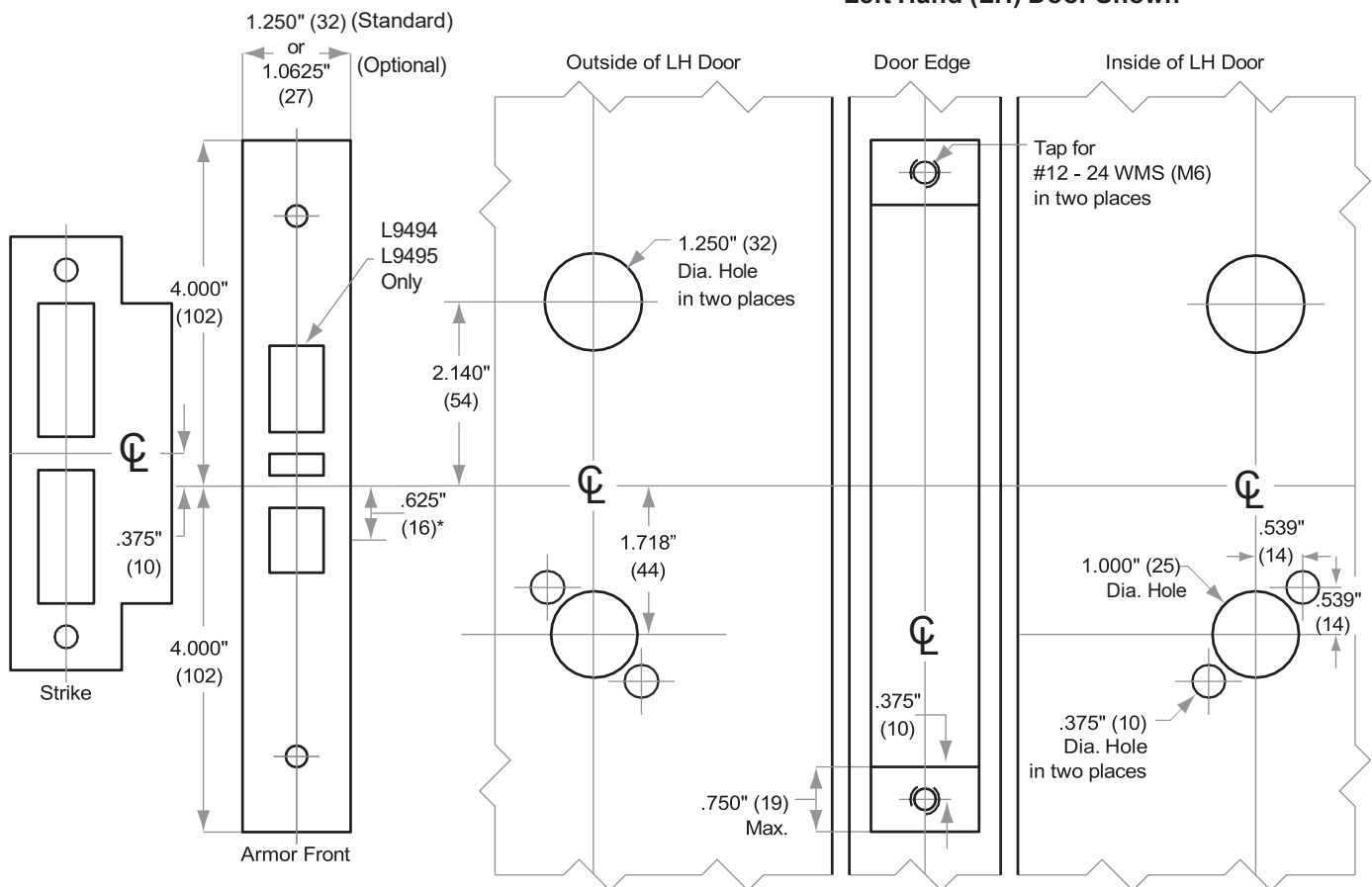

* Centerline of Armor Front to Centerline of Latch dimension

L/LV/LM/LMV-Series

ALLEGION™

Models L9094, L9095, L9494, L9495 Electrified Locks

Door Type: Wood or composite, flat or beveled

Trim: Escutcheon

This template should not be used for HSLR trim. Use template L965 for HSLR trim.

**For Case and Strike dimensions, see Template L1
Refer to Template L1 (revised October 2014 or
later) for information to prepare the door for
wire routing**

Left Hand (LH) Door Shown

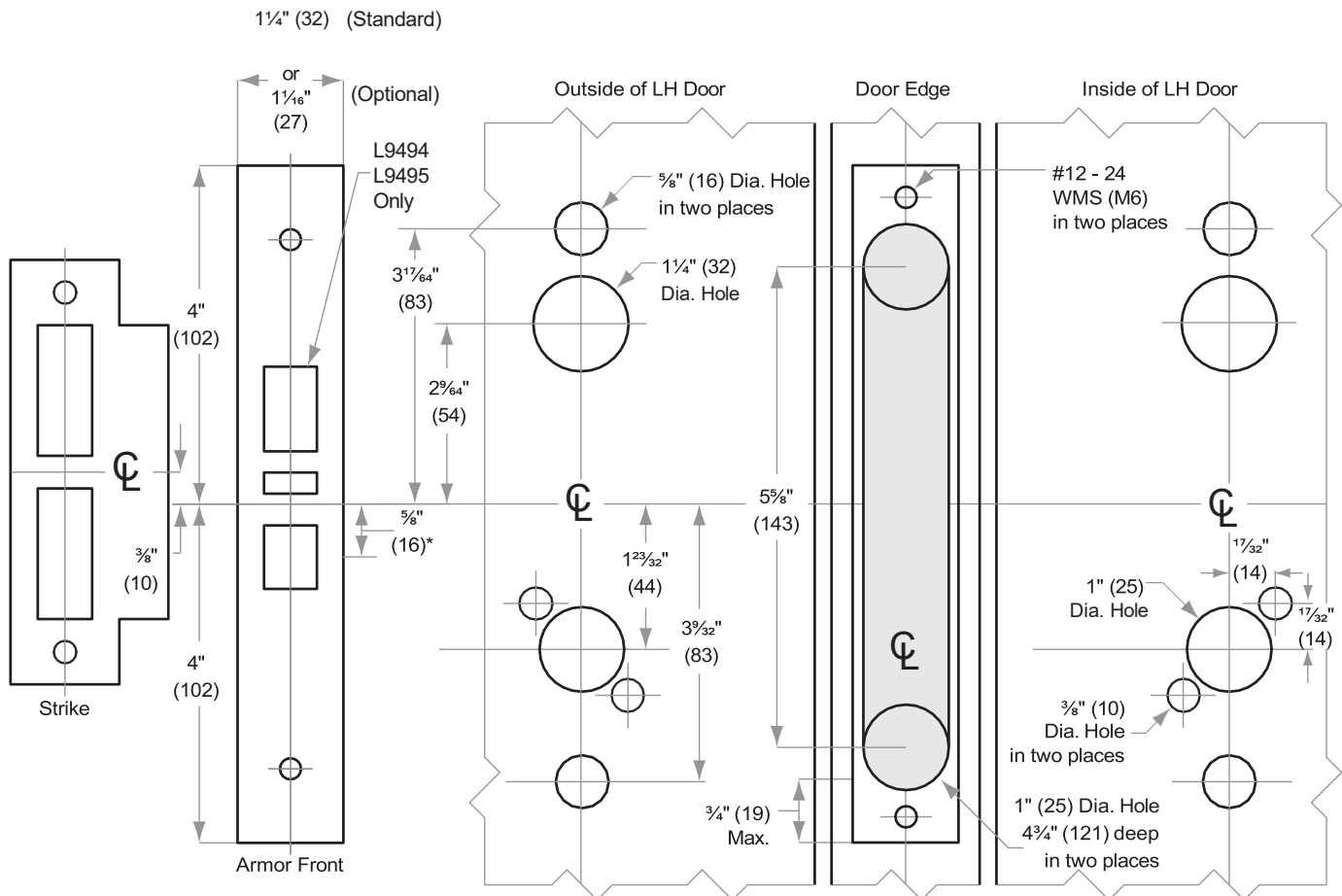

* Centerline of Armor Front to Centerline of Latch dimension

L/LV/LM/LMV-Series

ALLEGION™

Models L9094, L9095, L9494, L9495 Electrified Locks

Door Type: Wood or composite, flat or beveled

Trim: Rose

This template should not be used for HSLR trim. Use template L965 for HSLR trim.

**For Case and Strike dimensions, see Template L1
Refer to Template L1 (revised October 2014 or
later) for information to prepare the door for
wire routing**

Left Hand (LH) Door Shown

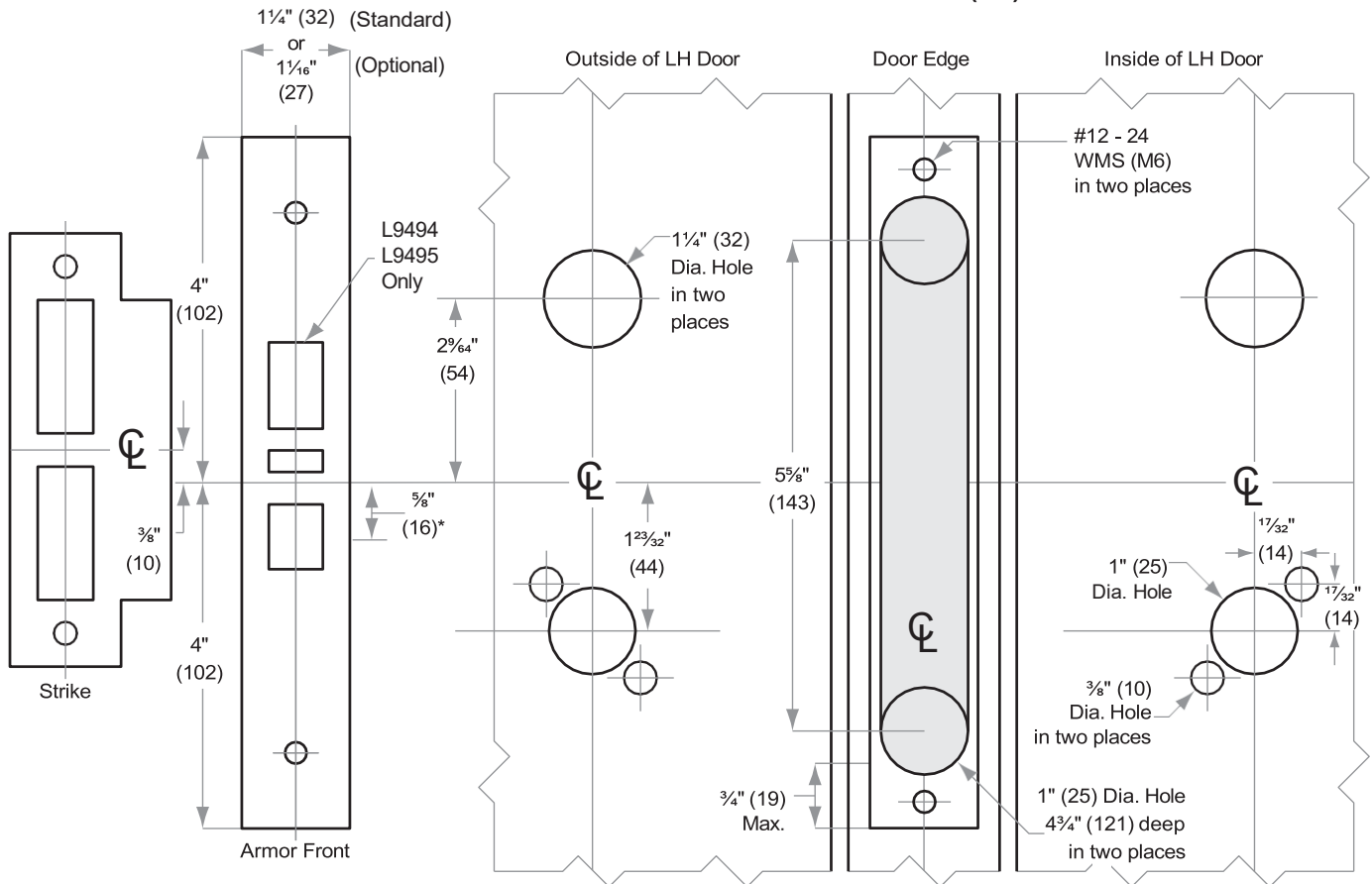

* Centerline of Armor Front to Centerline of Latch dimension

LM9200-Series

Model LM9210, LM9210F Locks

ALLEGION™

Door Type: Wood or composite, flat or beveled
 Trim: Escutcheon

For case and strike dimensions, see Template L3.

NOTE: For fire-rated locks less bottom latch (LBL), refer to template #L959 for additional door preparation instructions.

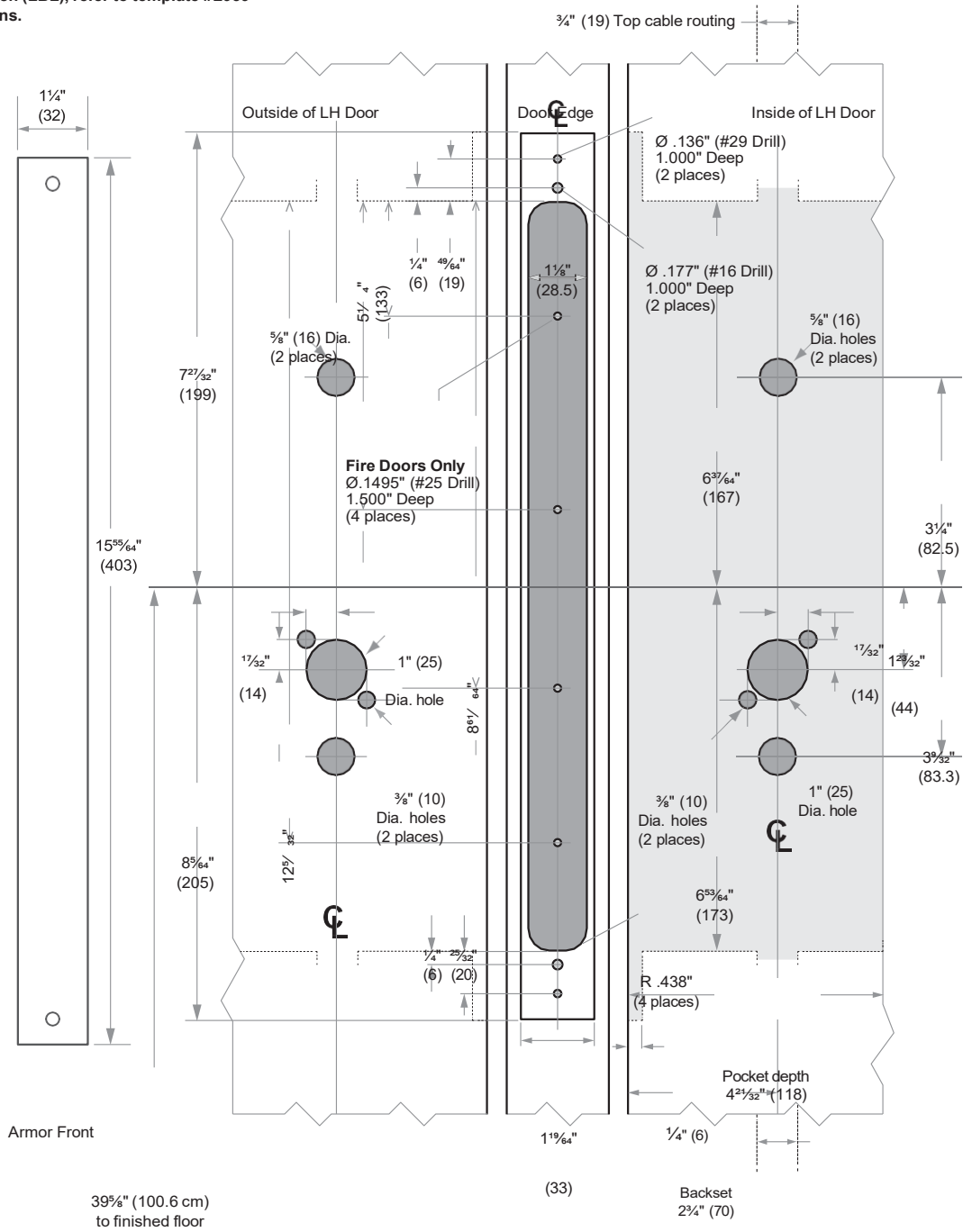
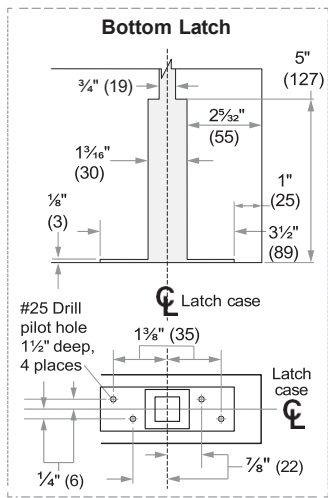
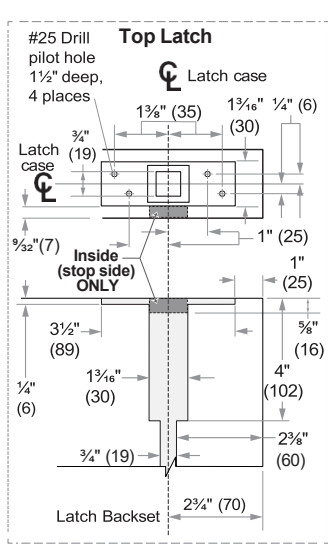



¾" (19) Bottom
cable routing
(exclude for
LBL application)

LM9200-Series

Model LM9210, LM9210F Locks

ALLEGION™

Door Type: Wood or composite, flat or beveled
 Trim: Rose

For case and strike dimensions, see Template L3.

NOTE: For fire-rated locks less bottom latch (LBL), refer to template #L959 for additional door preparation instructions.

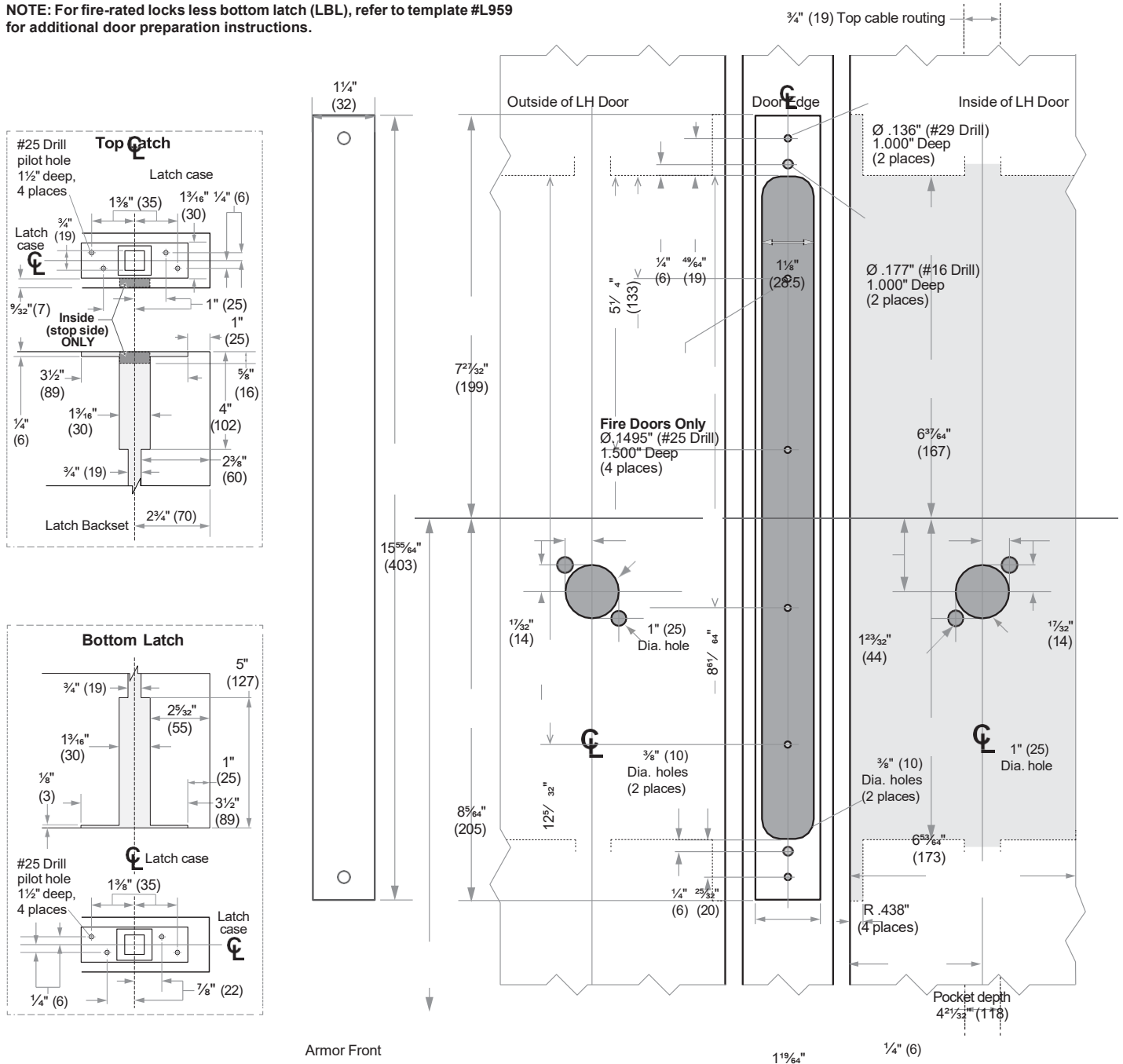

39 $\frac{3}{4}$ " (100.6 cm)
to finished floor

(33)

Backset
2 $\frac{3}{4}$ " (70)

$\frac{3}{4}$ " (19) Bottom
cable routing
(exclude for
LBL application)

LM9200-Series

Model LM9225, LM9225F Locks

ALLEGION™

Door Type: Wood or composite, flat or beveled
 Trim: Rose

For case and strike dimensions, see Template L3.

NOTE: For fire-rated locks less bottom latch (LBL), refer to template #L959 for additional door preparation instructions.

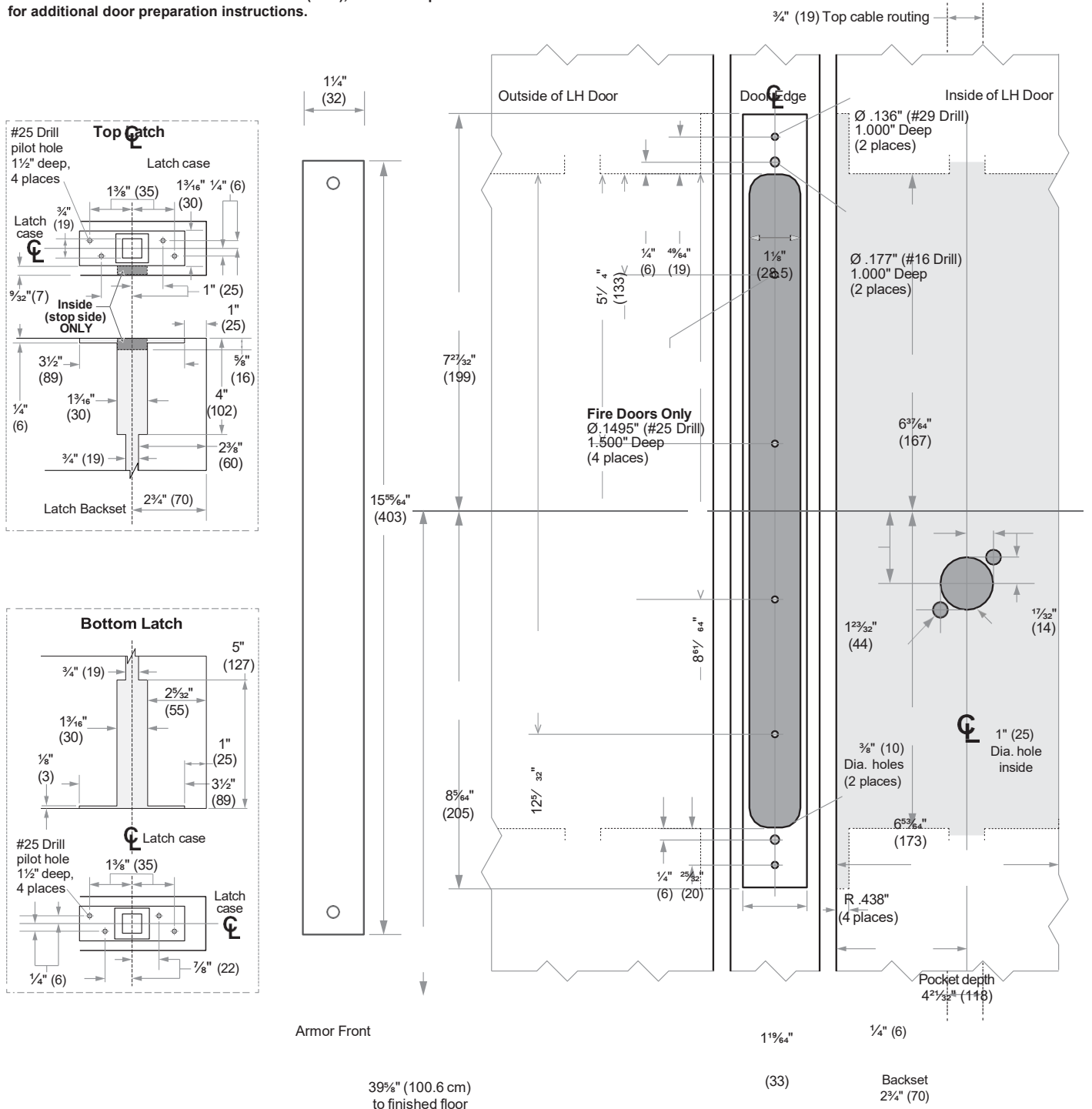

¾" (19) Bottom cable routing
(exclude for LBL application)

Dimensions shown in
parentheses () are in millimeters.

© 2021 Allegion
L930 Rev. 12/21

DRAWING IS NOT TO SCALE!
Customer service: 877-671-7011
We can help you find the correct guide
for

Door preparation template

L930

LM9200-Series

Models LM9250, LM9250F, LM9256, LM9256F Locks

ALLEGION™

Door Type: Wood or composite, flat or beveled

Trim: Escutcheon

For case and strike dimensions, see Template L3.

NOTE: For fire-rated locks less bottom latch (LBL), refer to template #L959 for additional door preparation instructions.

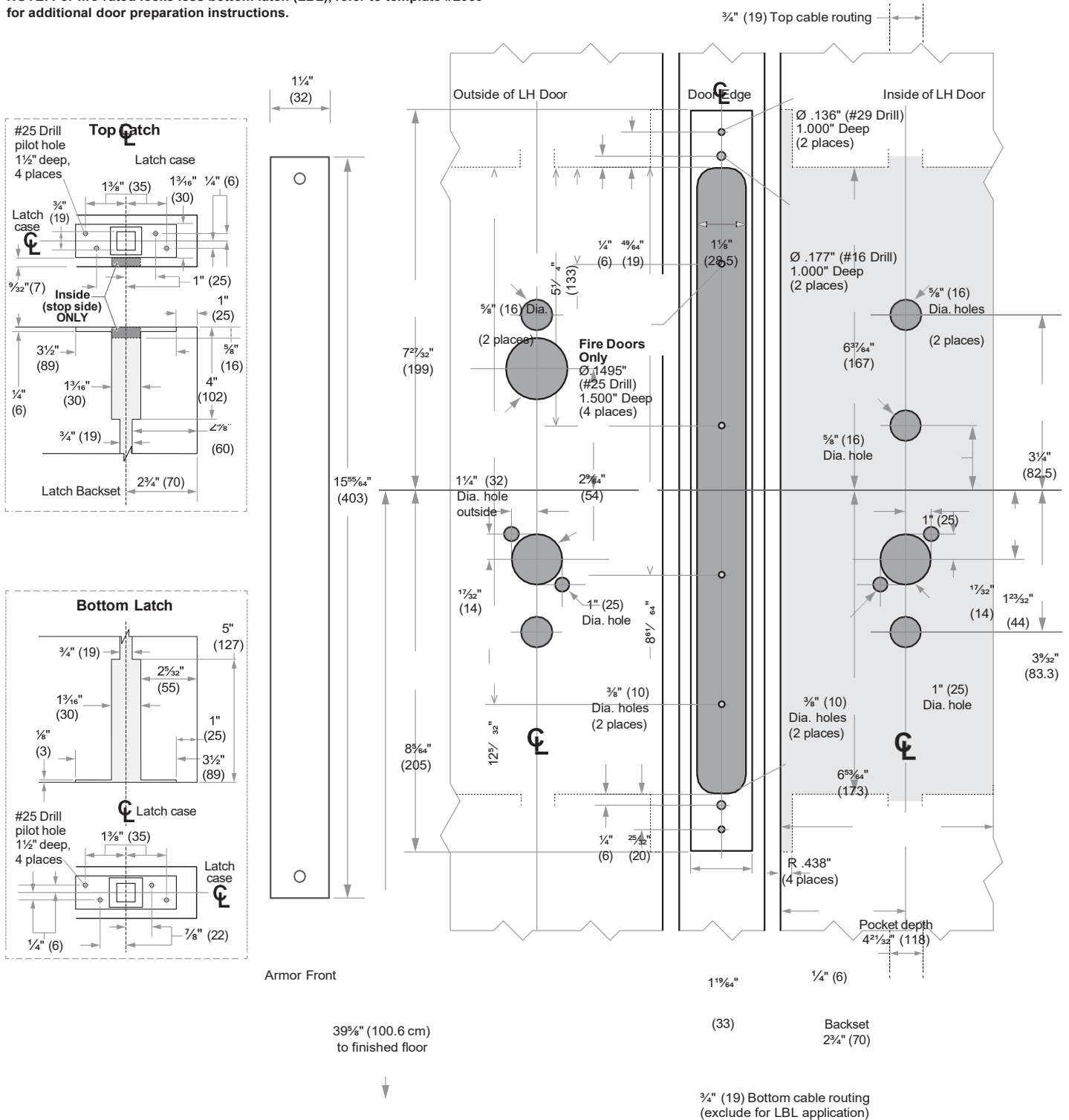

Dimensions shown in
parentheses () are in millimeters.

© 2021 Allegion
L931 Rev. 12/21

DRAWING IS NOT TO SCALE!
Customer service: 877-671-7011
We can help you find the correct guide
for

Door preparation template

L931

Dimensions shown in
parentheses () are in millimeters.

© 2021 Allegion
L932 Rev. 12/21

DRAWING IS NOT TO SCALE!
Customer service: 877-671-7011
We can help you find the correct guide
for

Door preparation template

L932

LM9200-Series

Models LM9270, LM9270F, LM9280, LM9280F Locks

ALLEGION™

Door Type: Wood or composite, flat or beveled

Trim: Escutcheon

For case and strike dimensions, see Template L3.

NOTE: For fire-rated locks less bottom latch (LBL), refer to template #L959 for additional door preparation instructions.

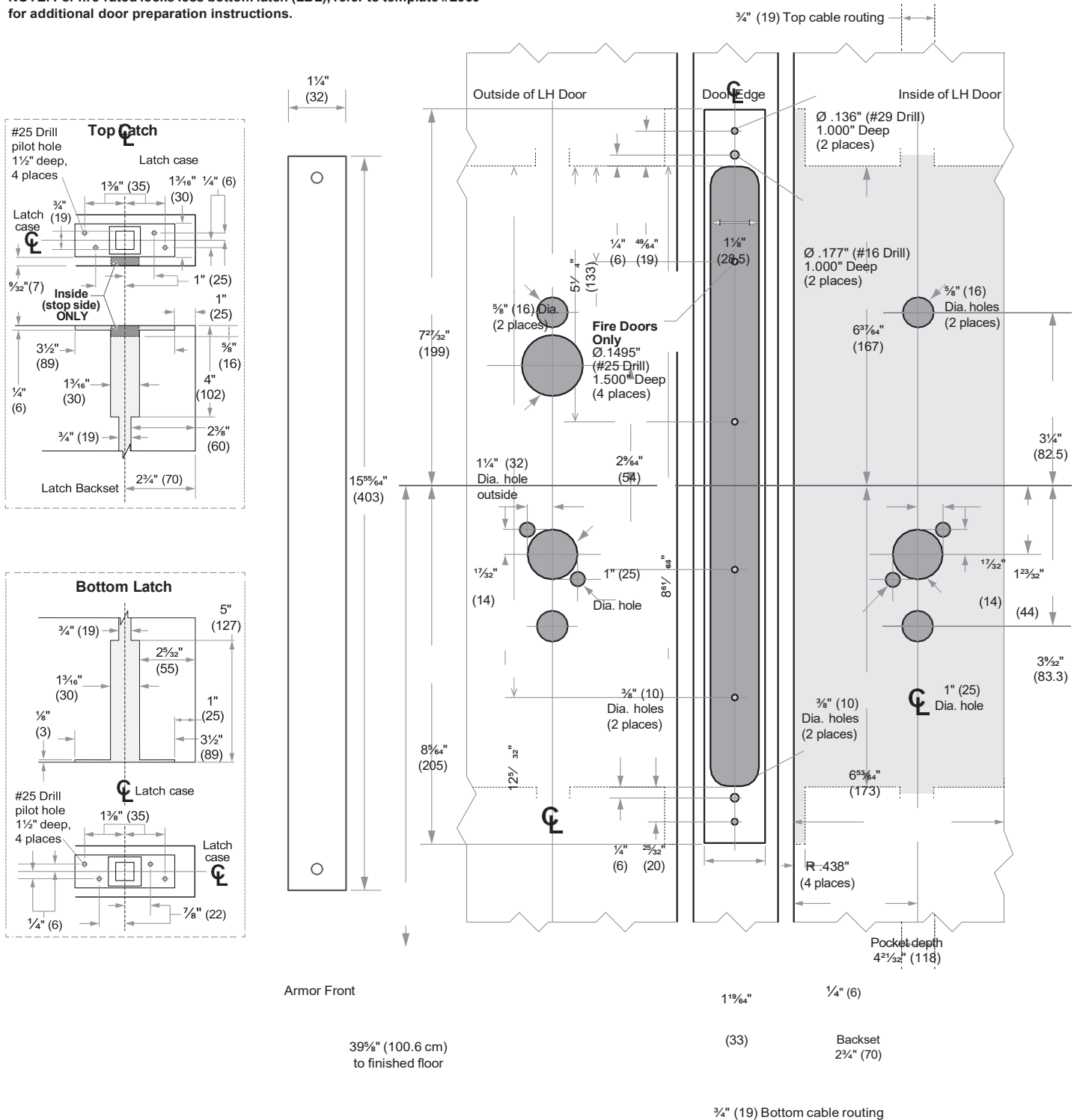

(exclude for LBL application)

Dimensions shown in
parentheses () are in millimeters.

© 2021 Allegion
L933 Rev. 12/21

DRAWING IS NOT TO SCALE!
Customer service: 877-671-7011
**We can help you find the correct guide
for**

Door preparation template

L933

LM9200-Series

Models LM9270, LM9270F, LM9280, LM9280F Locks

ALLEGION™

Door Type: Wood or composite, flat or beveled

Trim: Rose

For case and strike dimensions, see Template L3.

NOTE: For fire-rated locks less bottom latch (LBL), refer to template #L959

for additional door preparation instructions.

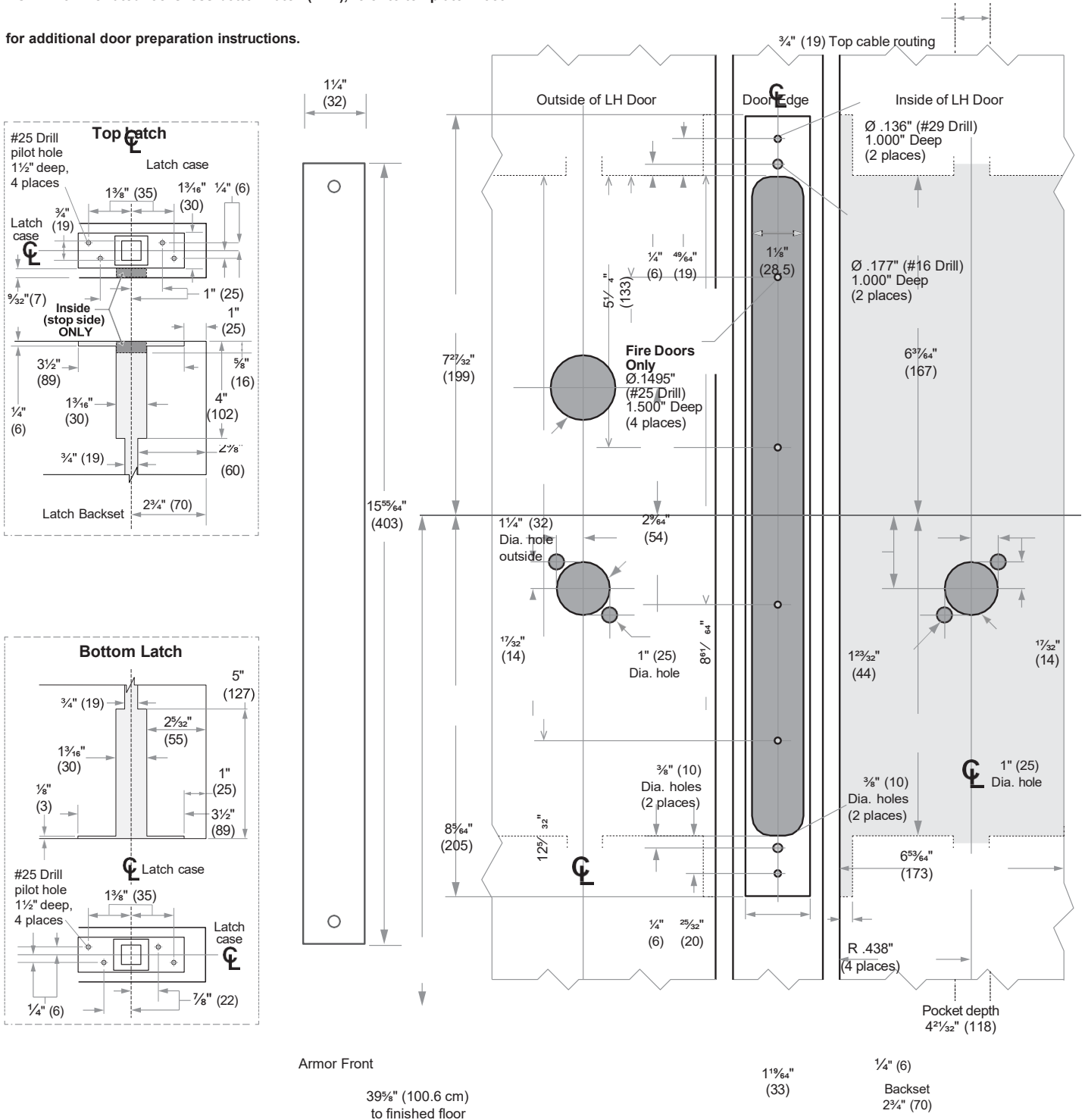

¾" (19) Bottom cable routing
(exclude for LBL application)

Dimensions shown in
parentheses () are in millimeters.

© 2021 Allegion
L934 Rev. 12/21

DRAWING IS NOT TO SCALE!
Customer service: 877-671-7011
**We can help you find the correct guide
for**

Door preparation template

L934

LM9200-Series

Model LM9271, LM9271F Locks

ALLEGION™

Door Type: Wood or composite, flat or beveled
 Trim: Escutcheon

For case and strike dimensions, see Template L3.

NOTE: For fire-rated locks less bottom latch (LBL), refer to template #L959 for additional door preparation instructions.

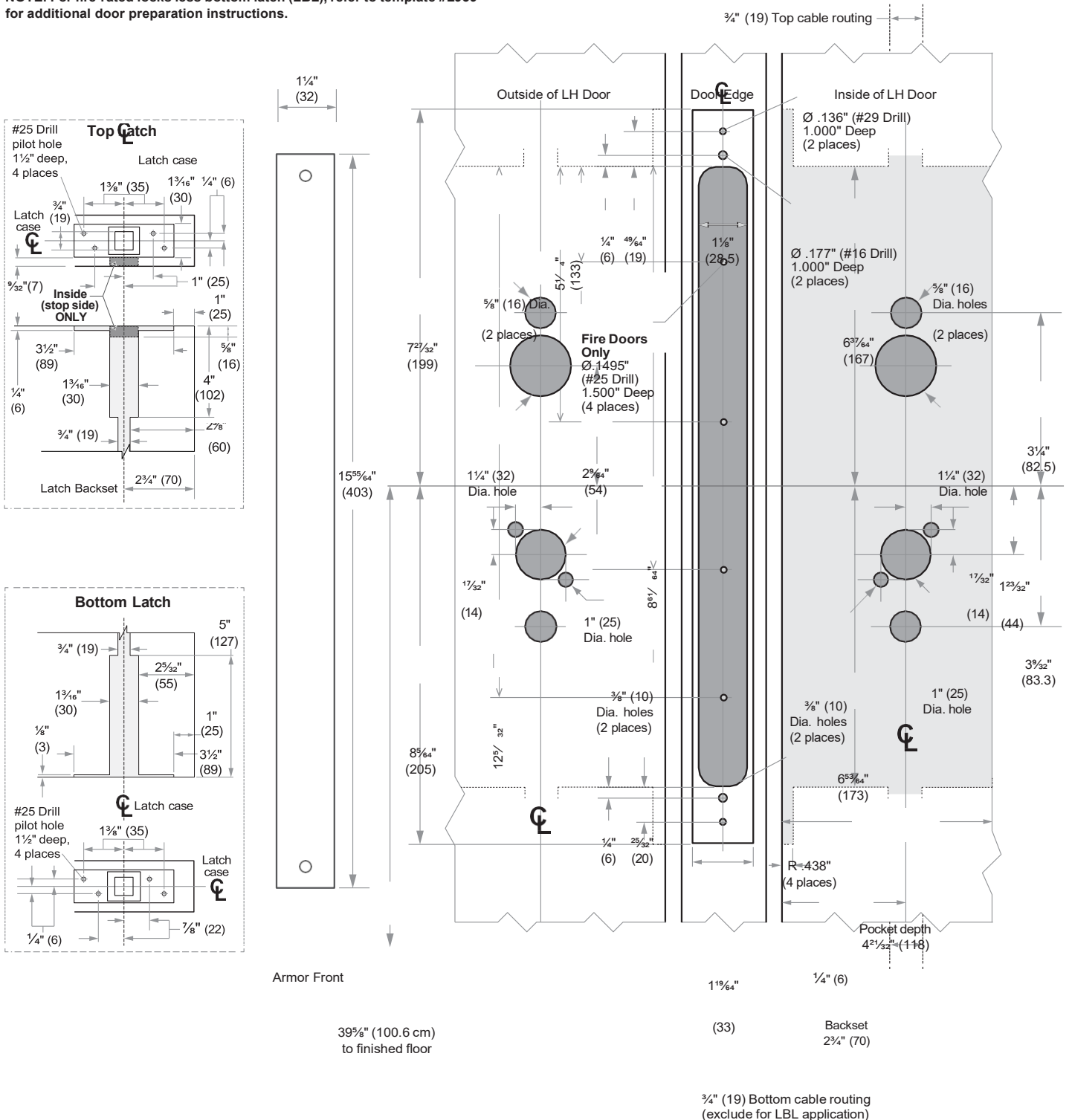

Dimensions shown in
parentheses () are in millimeters.

© 2021 Allegion
L935 Rev. 12/21

DRAWING IS NOT TO SCALE!
Customer service: 877-671-7011
**We can help you find the correct guide
for**

Door preparation template

L935

3/4" (19) Bottom cable routing
(exclude for LBL application)

Dimensions shown in
parentheses () are in millimeters.

DRAWING IS NOT TO SCALE!
**Customer service: 877-671-
7011**

Door preparation template

pilot hole 1½" deep, 4 places

Latch
case

1¾" (35)

Latch
case

39⅝" (100.6 cm)
to finished floor

¾" (19) Bottom cable routing
(exclude for LBL application)

¼" (6)

⅞" (22)

Dimensions shown in
parentheses () are in millimeters.

DRAWING IS NOT TO SCALE!
Customer service: 877-671-7011

Door preparation template

LM9200-Series

Models LM9290 EL/EU, LM9290F EL/EU, LM9291 EL/EU, LM9291F EL/EU Locks

ALLEGION™

Door Type: Wood or composite, flat or beveled

Trim: Rose

For case and strike dimensions, see Template L3.

NOTE: For fire-rated locks less bottom latch (LBL), refer to template #L959 for additional door preparation instructions.

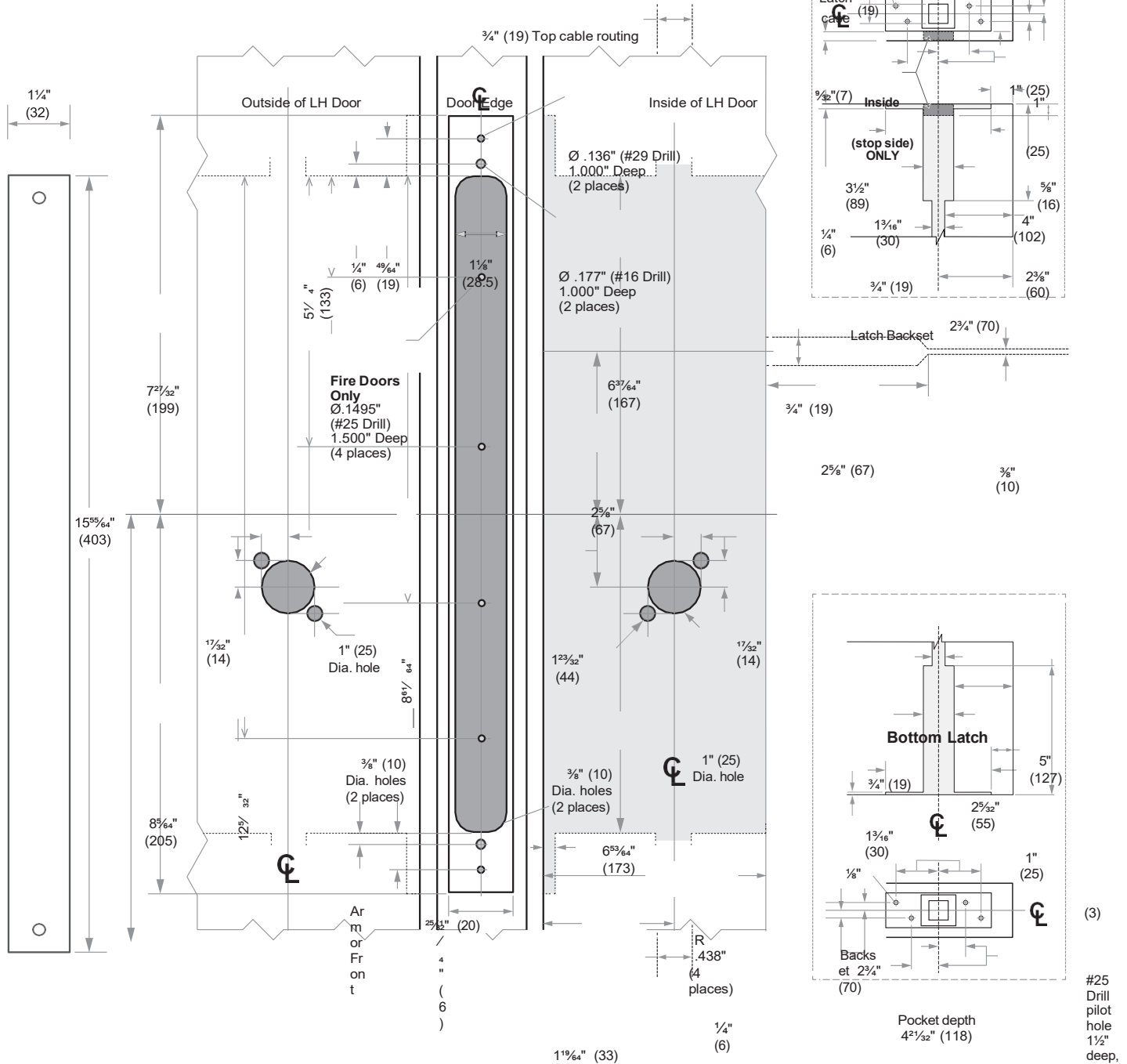

4 places

3
1
/
2
" Lat
ch (8
cas
e 9
)
1 3/8" (35)

L
a
t
c
h
c
a
s
e

39 5/8" (100.6 cm)
to finished floor

3/4" (19) Bottom cable routing
(exclude for LBL application)

1/4" (6)

7/8" (22)

Dimensions shown in
parentheses () are in millimeters.

DRAWING IS NOT TO SCALE!
Customer service: 877-671-7011

Door preparation template

LM9200-Series

ALLEGION™

Models LM9292 EL/EU, LM9292F EL/EU, LM9293 EL/EU, LM9293F EL/EU Locks

Door Type: Wood or composite, flat or beveled
Trim: Escutcheon

For case and strike dimensions, see Template L3.

NOTE: For fire-rated locks less bottom latch (LBL), refer to template #L959 for additional door preparation instructions.

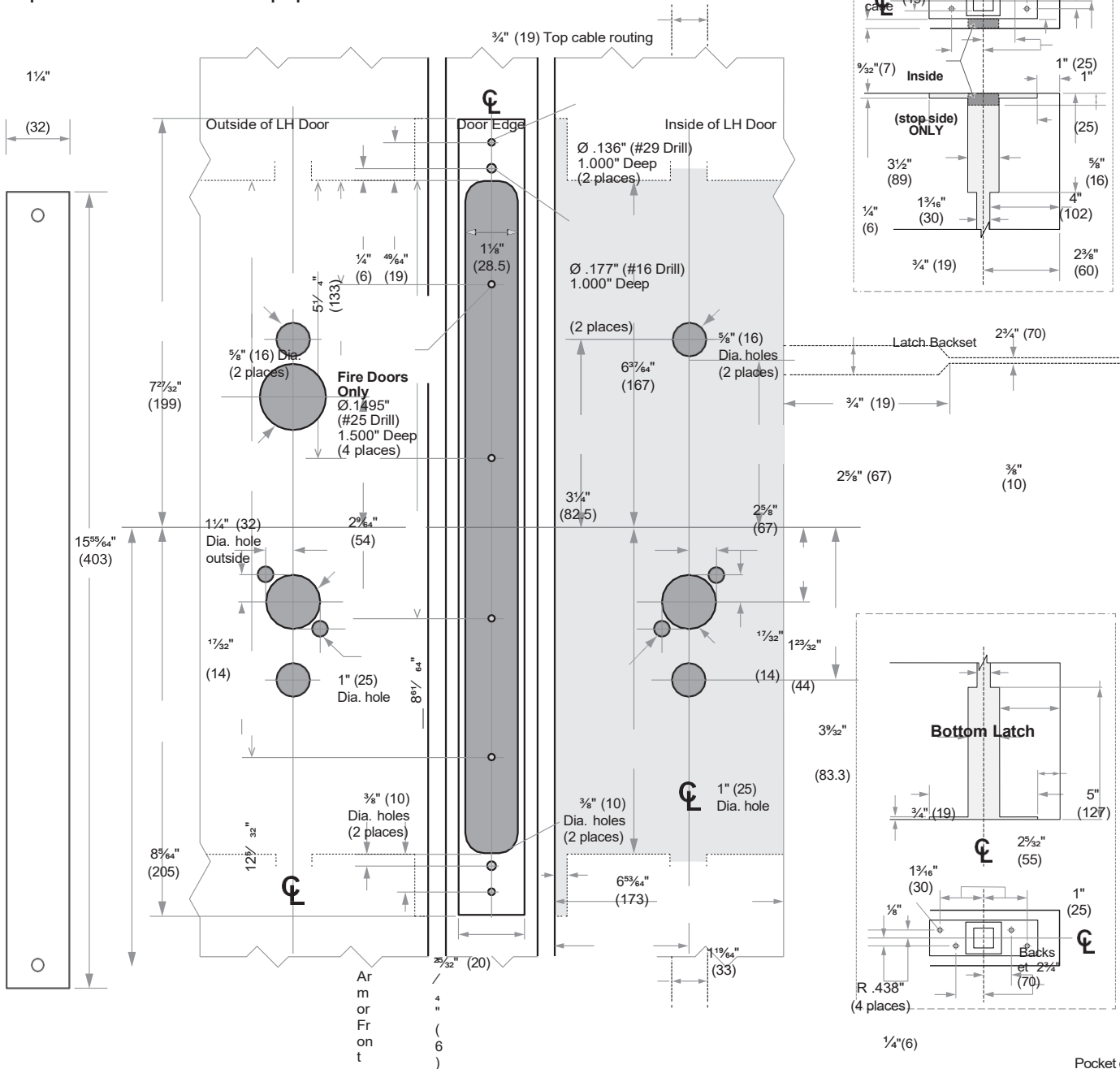

(3)

#25 Drill pilot
hole 1½"
deep, 4
places

3
,
/
2
"
L
a
t
c
h
)
c
a
s
e

1¾"
(35)

L
a
t
c
h
c
a
s
e

39¾" (100.6 cm)
to finished floor

¾" (19) Bottom cable routing
(exclude for LBL application)

¼" (6)

⅞" (22)

Dimensions shown in
parentheses () are in millimeters.

DRAWING IS NOT TO SCALE!
Customer service: 877-671-7011

Door preparation template

Armor Front	$1\frac{19}{64}$ " (33)	(6) Pocket depth $4\frac{21}{32}$ " (118)	#25 Drill pilot hole $1\frac{1}{2}$ " deep, 4 places	Latch case $1\frac{3}{8}$ " (35) Latch case
$39\frac{5}{8}$ " (100.6 cm) to finished floor	$\frac{3}{4}$ " (19) Bottom cable routing (exclude for LBL application)		$\frac{1}{4}$ " (6)	$\frac{7}{8}$ " (22)

LM9200-Series

Models LM9294 EL/EU, LM9294F EL/EU, LM9295 EL/EU, LM9295F EL/EU Locks

ALLEGION™

Door Type: Wood or composite, flat or beveled

Trim: Escutcheon

For case and strike dimensions, see Template L3.

NOTE: For fire-rated locks less bottom latch (LBL), refer to

template #L959 for additional door preparation instructions.

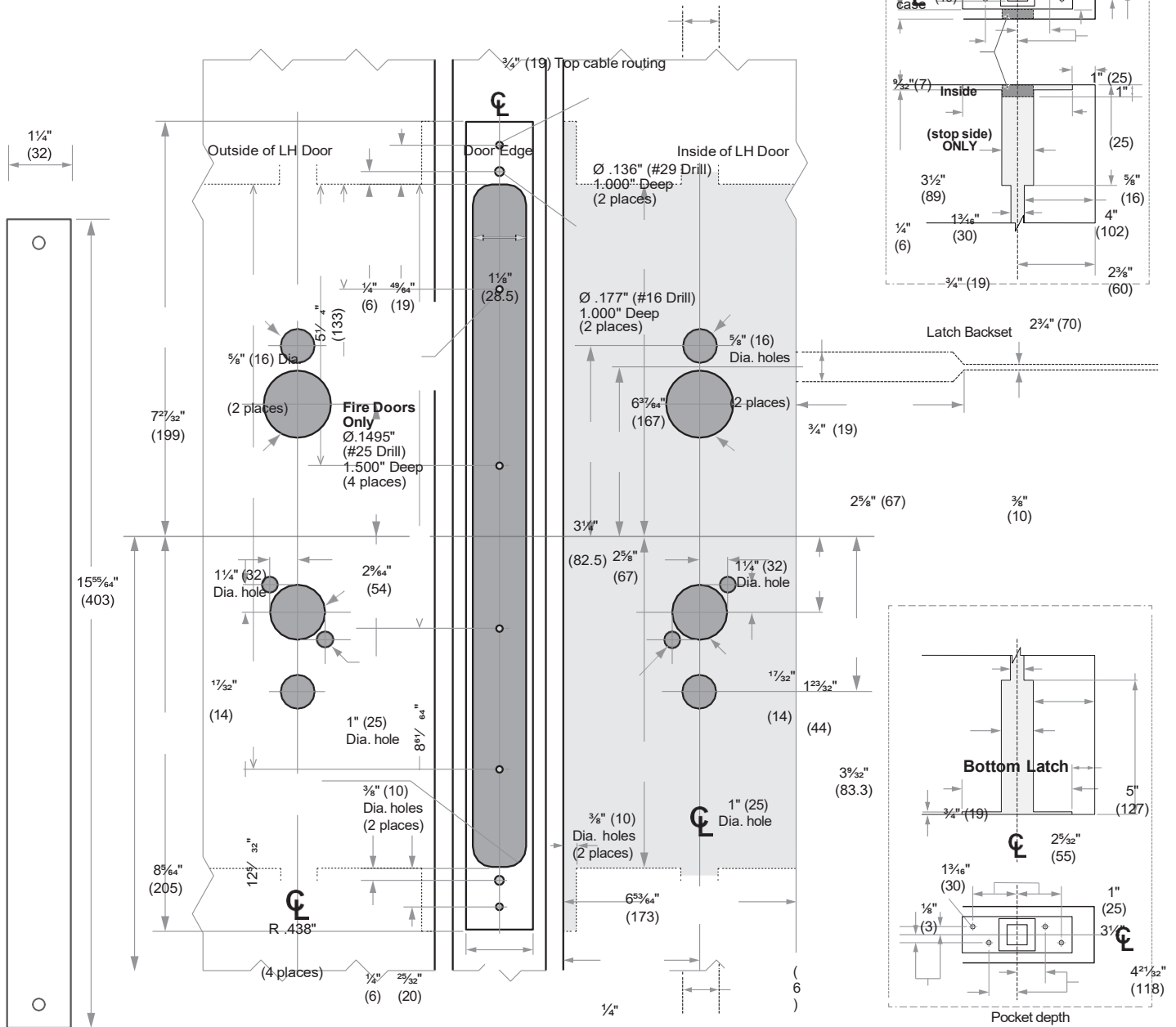

(89)

#25 Drill pilot hole 1½" deep, 4 places

L
a
t
e
s
t
c
a
b
l
e
c
o
n
f
i
g
u
r
e
s

1⅜"
(35)

Armor Front

39⅝" (100.6 cm)
to finished floor

1⅞"
(33)

Backset
2¾" (70)

¾" (19) Bottom cable
routing (exclude
for LBL application)

¼" (6)

⅞" (22)

LM9200-Series

ALLEGION™

Models LM9294 EL/EU, LM9294F EL/EU, LM9295 EL/EU, LM9295F EL/EU Locks

Door Type: Wood or composite, flat or beveled

Trim: Rose

For case and strike dimensions, see Template L3.

NOTE: For fire-rated locks less bottom latch (LBL), refer to template #L959 for additional door preparation instructions.

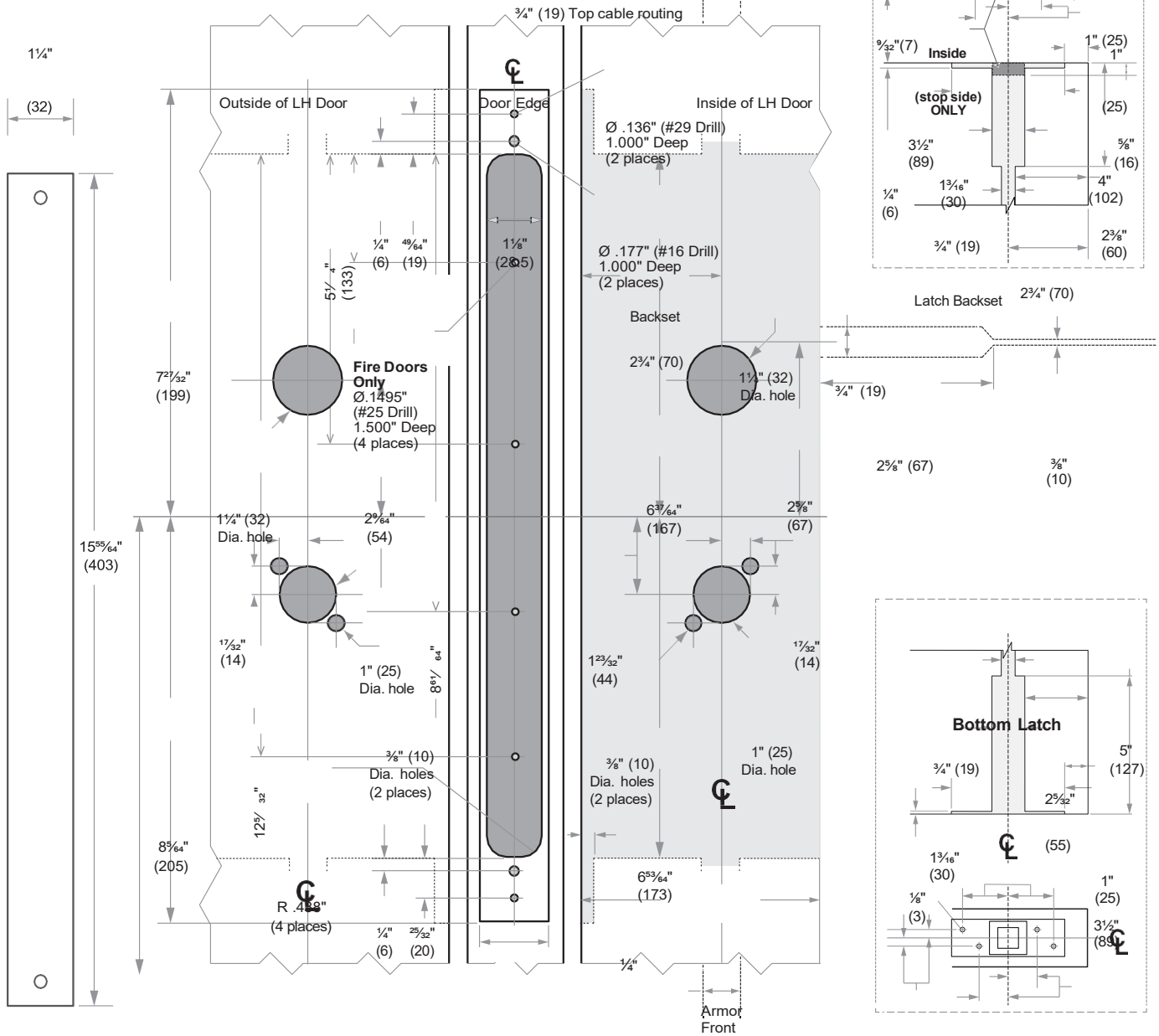

1 1/4" (33)

(6)

#25 Drill
pilot
hole
1 1/2"
deep, 4
places

Latch
case

1 3/8" (35)

Latch
case

Pocket
depth
4 2 1/2"
(118)

39 5/8" (100.6 cm)
to finished floor

3/4" (19) Bottom cable routing
(exclude for LBL application)

1/4" (6)

7/8" (22)

LM9200-Series

Models LM9210, LM9210M Locks

ALLEGION™

Door Type: Metal, flat or beveled
 Trim: Escutcheon

For case and strike dimensions, see Template L3.

NOTES:

Suitable reinforcement required for metal door installation.
 For fire-rated locks less bottom latch (LBL), refer to
 template #L960 for additional door preparation instructions.

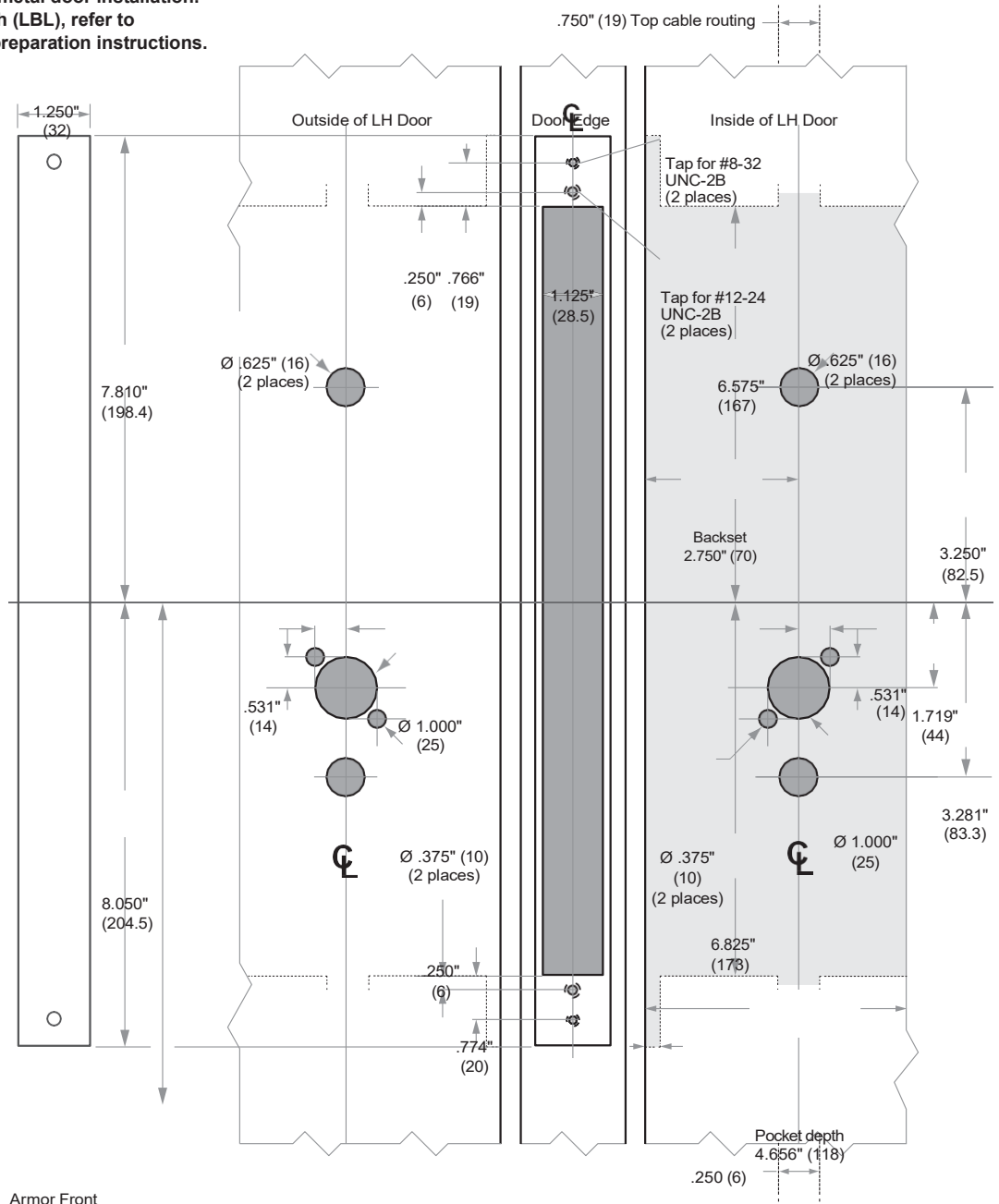
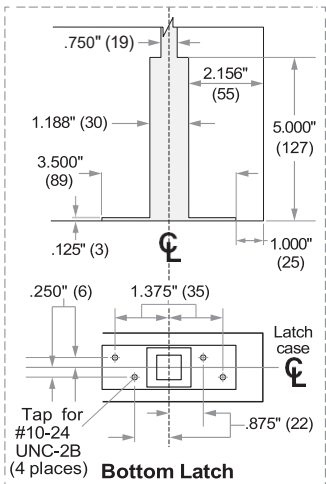
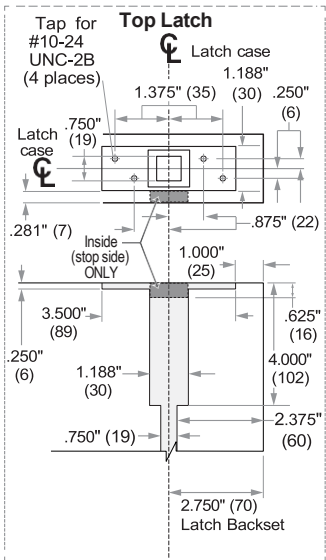

39.625" (100.6 cm)
to finished floor

.750" (19) Bottom cable routing
(exclude for LBL application)

LM9200-Series

Models LM9210, LM9210M Locks

ALLEGION™

Door Type: Metal, flat or beveled
 Trim: Rose

For case and strike dimensions, see Template L3.

NOTES:

Suitable reinforcement required for metal door installation.
 For fire-rated locks less bottom latch (LBL), refer to
 template #L960 for additional door preparation instructions.

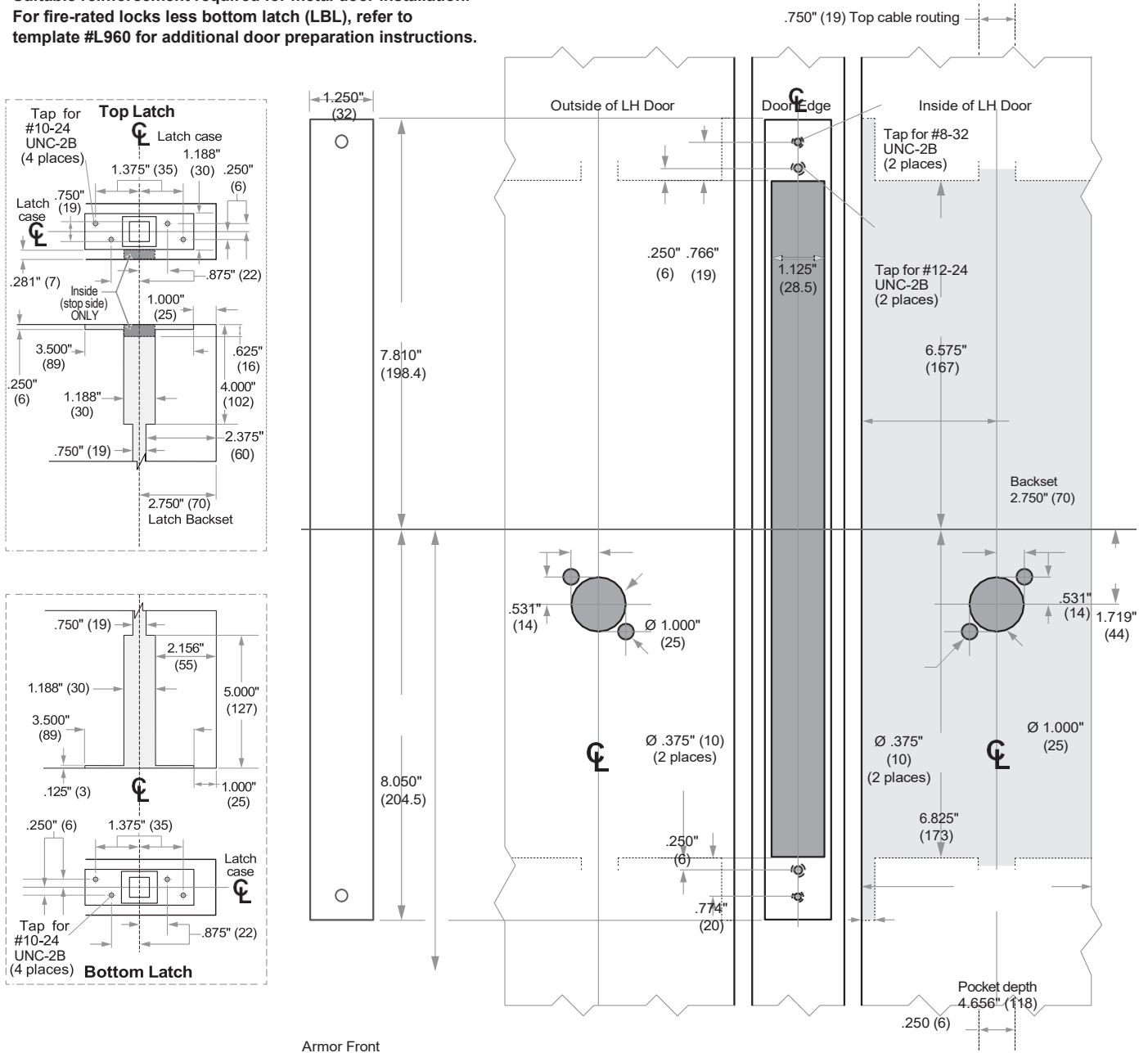

39.625" (100.6 cm)
to finished floor

.750" (19) Bottom cable routing
(exclude for LBL application)

LM9200-Series

Models LM9225, LM9225M Locks

ALLEGION™

Door Type: Metal, flat or beveled
 Trim: Rose

For case and strike dimensions, see Template L3.

NOTES:
 Suitable reinforcement required for metal door installation.
 For fire-rated locks less bottom latch (LBL), refer to
 template #L960 for additional door preparation instructions.

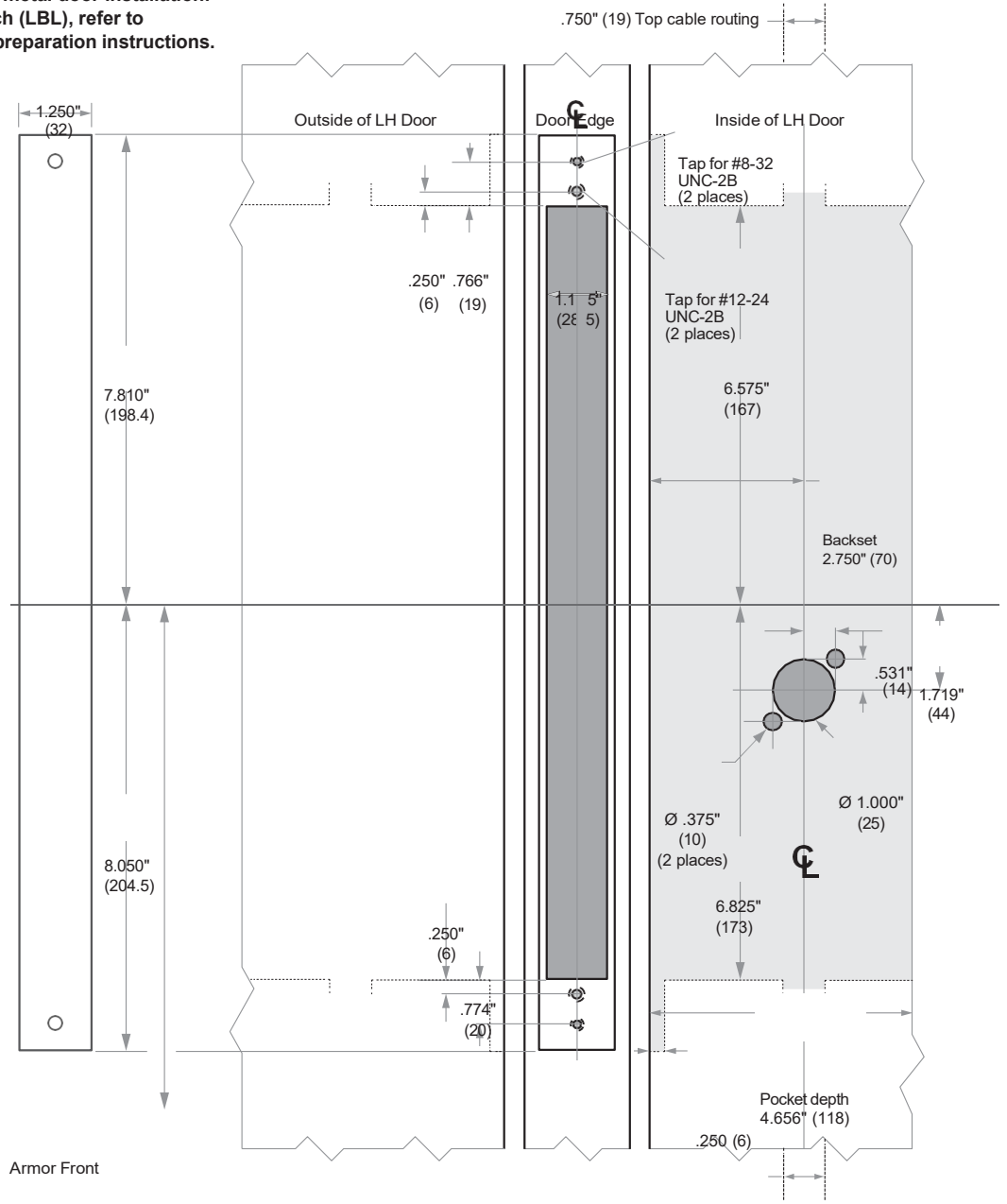
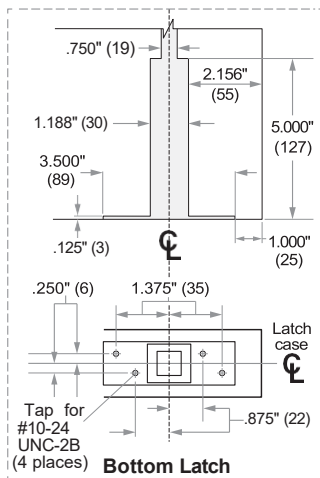
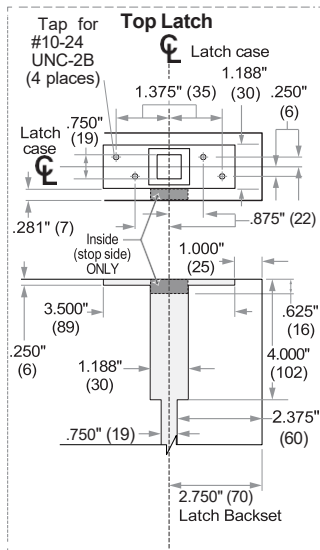

39.625" (100.6 cm)
 to finished floor

.750"
(19)
Bottom
cable
routing
g
(exclu
de for
LBL
applic
ation)

LM9200-Series

Models LM9250, LM9250M, LM9256, LM9256M Locks

ALLEGION™

Door Type: Metal, flat or beveled

Trim: Escutcheon

For case and strike dimensions, see Template L3.

NOTES:

Suitable reinforcement required for metal door installation.

For fire-rated locks less bottom latch (LBL), refer to template #L960 for additional door preparation instructions.

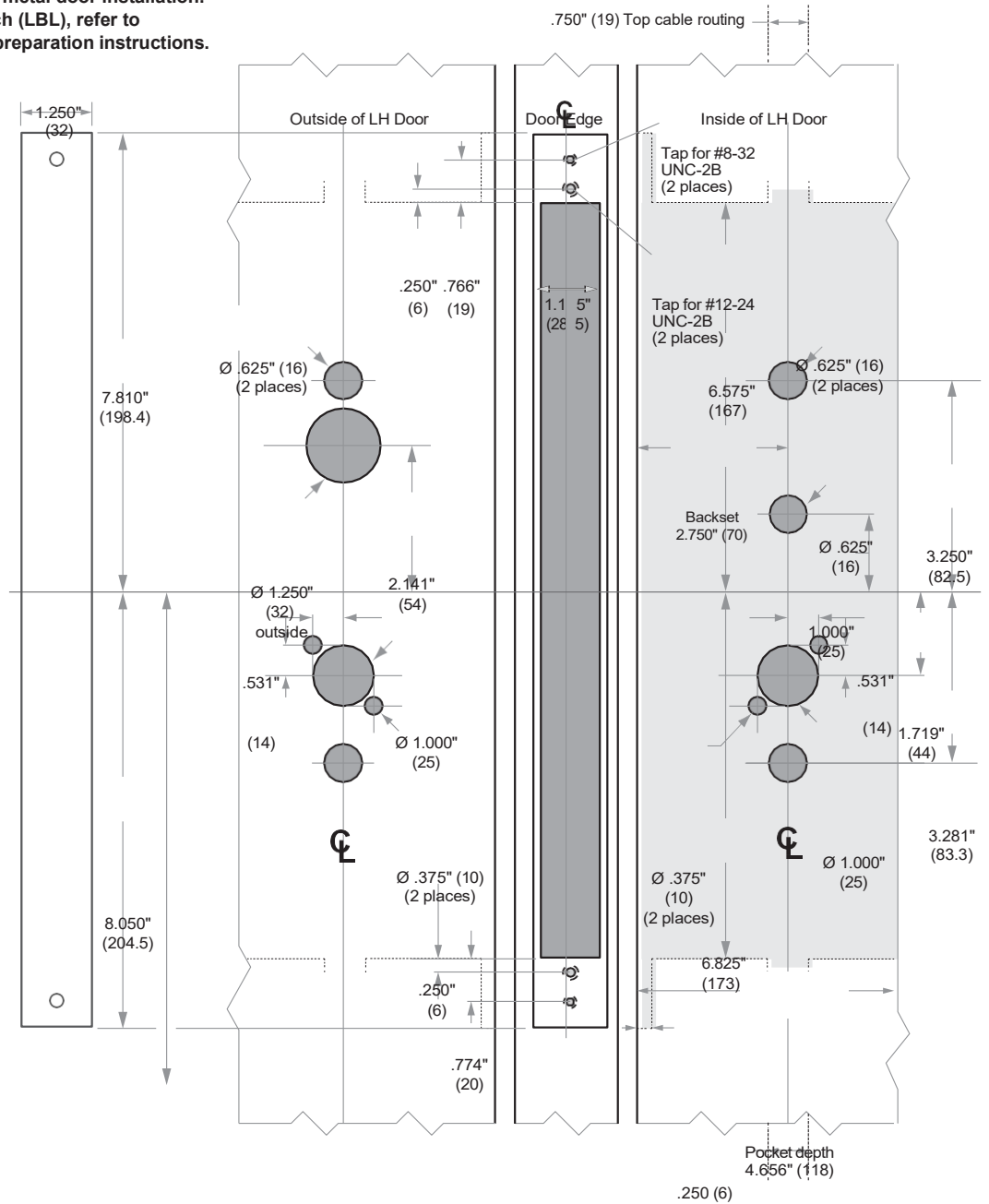
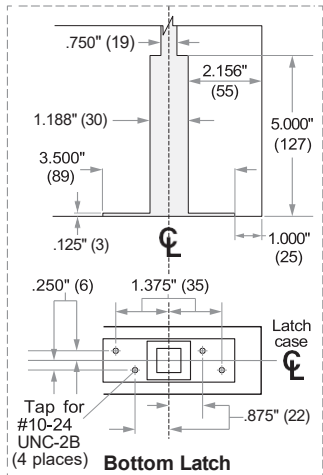
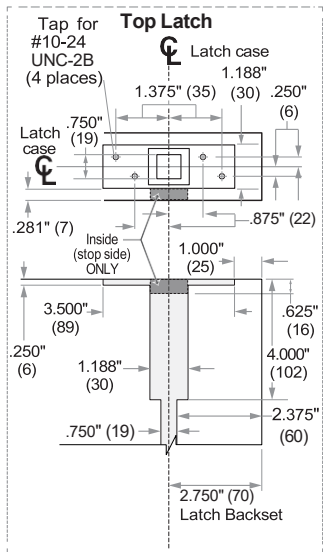

Armor Front

39.625" (100.6 cm)
to finished floor

.750" (19) Bottom cable routing
(exclude for LBL application)

LM9200-Series

Models LM9250, LM9250M, LM9256, LM9256M Locks

ALLEGION™

Door Type: Metal, flat or beveled

Trim: Rose

For case and strike dimensions, see Template L3.

NOTES:

Suitable reinforcement required for metal door installation.

For fire-rated locks less bottom latch (LBL), refer to template #L960 for additional door preparation instructions.

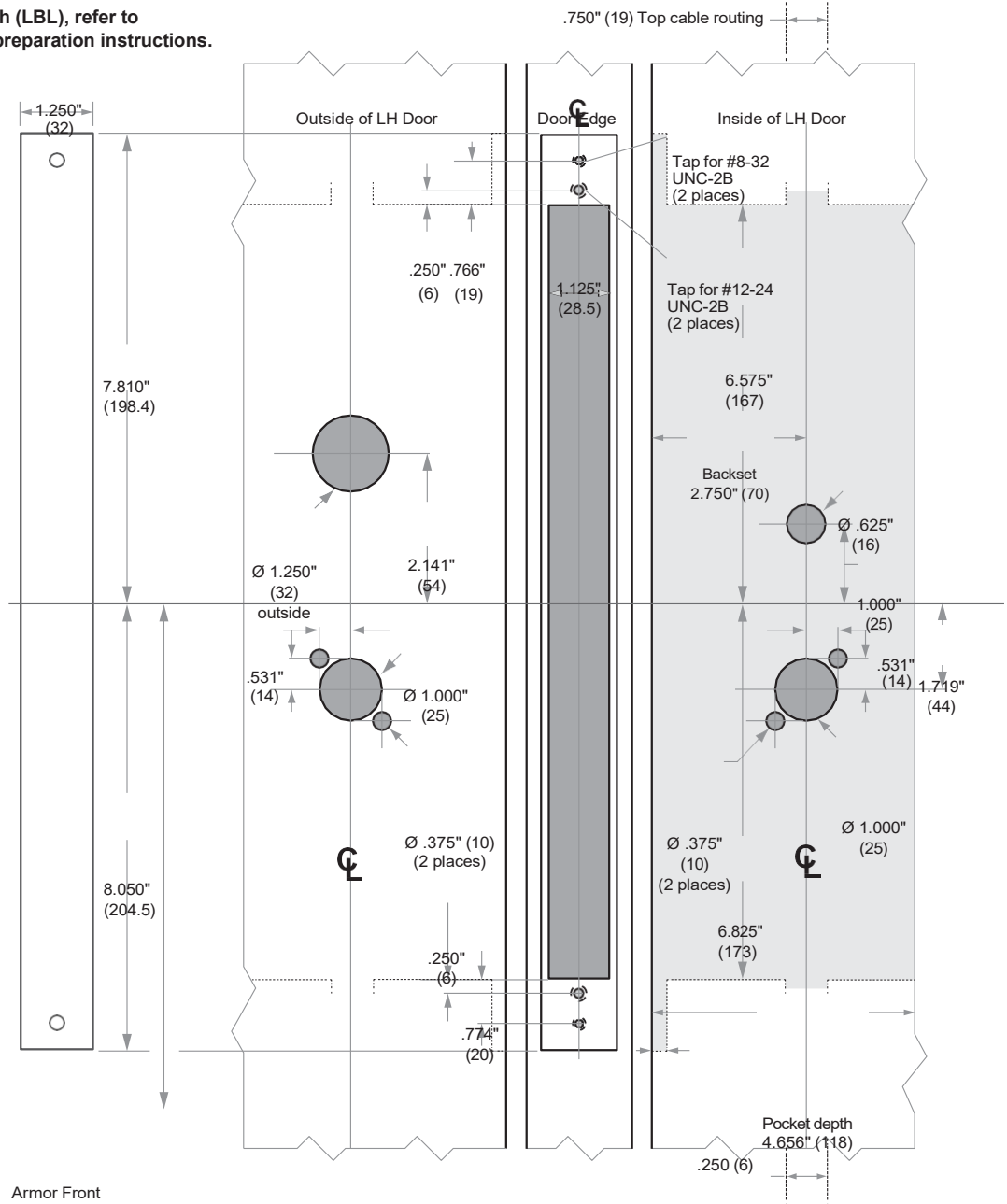
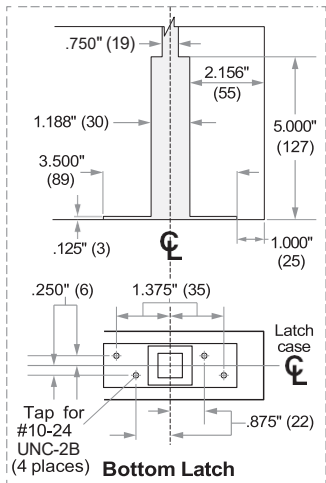
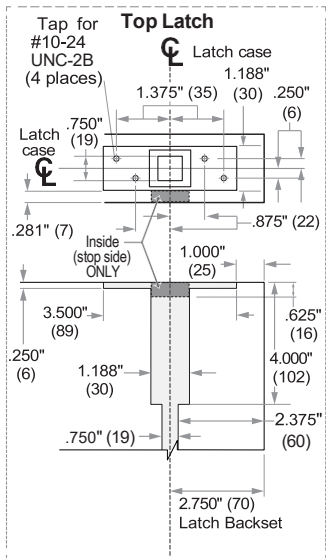

Armor Front

39.625" (100.6 cm)
to finished floor

.750" (19) Bottom cable routing
(exclude for LBL application)

LM9200-Series

ALLEGION™

Models LM9270, LM9270M, LM9280, LM9280M Locks

Door Type: Metal, flat or beveled

Trim: Escutcheon

For case and strike dimensions, see Template L3.

NOTES:

Suitable reinforcement required for metal door installation.

For fire-rated locks less bottom latch (LBL), refer to template #L960 for additional door preparation instructions.

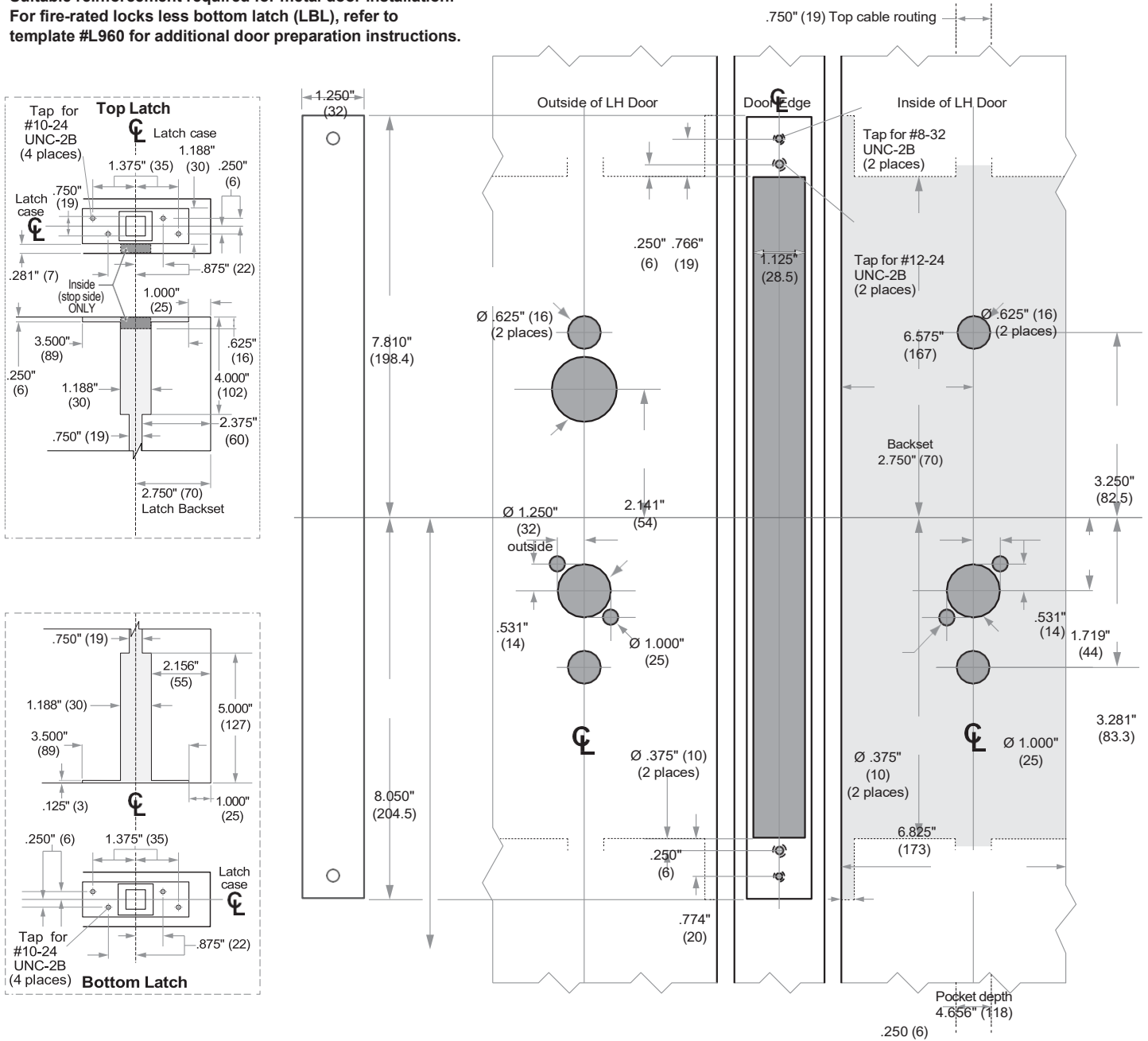

Armor Front

39.625" (100.6 cm)
to finished floor

.750" (19) Bottom cable routing
(exclude for LBL application)

LM9200-Series

ALLEGION™

Models LM9270, LM9270M, LM9280, LM9280M Locks

Door Type: Metal, flat or beveled

Trim: Rose

For case and strike dimensions, see Template L3.

NOTES:

Suitable reinforcement required for metal door installation.

For fire-rated locks less bottom latch (LBL), refer to template #L960 for additional door preparation instructions.

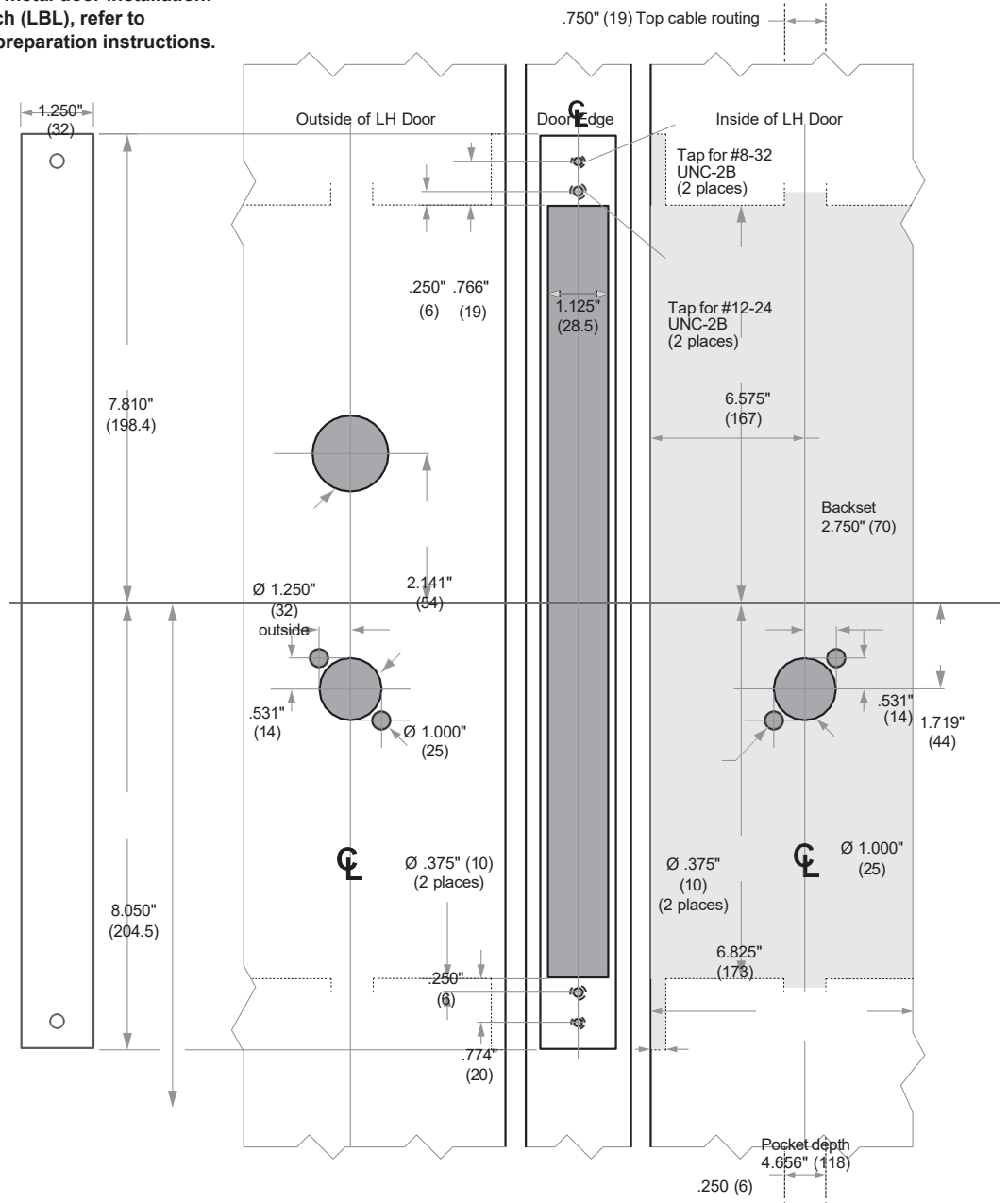
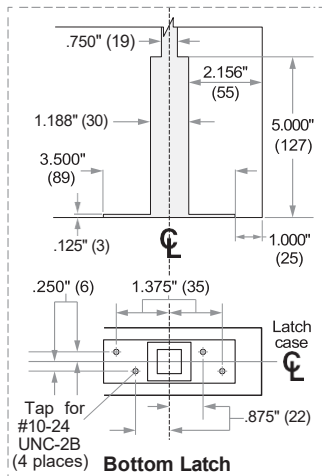
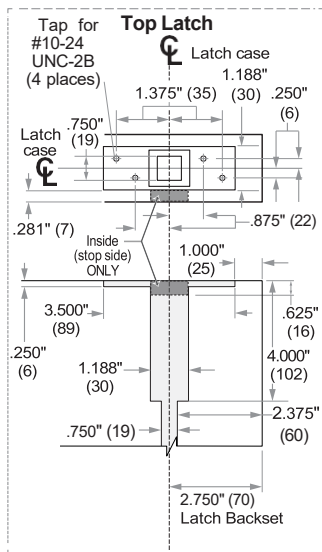

Armor Front

39.625" (100.6 cm)
to finished floor

Dimensions shown in
parentheses () are in millimeters.

© 2021 Allegion
L950 Rev. 12/21

DRAWING IS NOT TO SCALE!
Customer service: 877-671-7011
**We can help you find the correct guide
for**

Door preparation template

L950

LM9200-Series

Models LM9271, LM9271M Locks

ALLEGION™

Door Type: Metal, flat or beveled
 Trim: Escutcheon

For case and strike dimensions, see Template L3.

NOTES:
 Suitable reinforcement required for metal door installation.
 For fire-rated locks less bottom latch (LBL), refer to
 template #L960 for additional door preparation instructions.

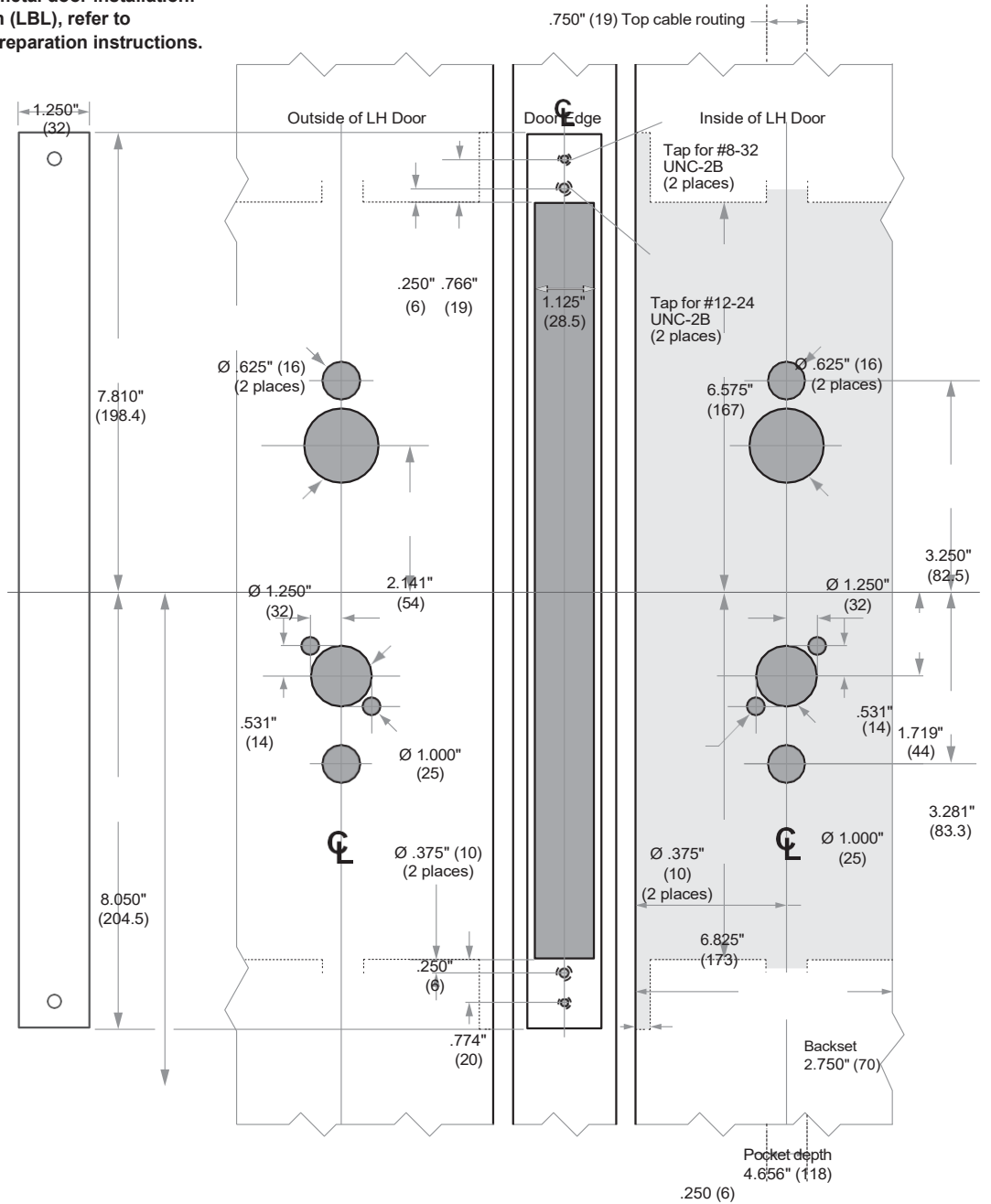
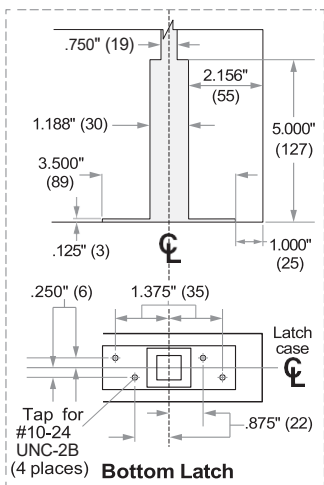
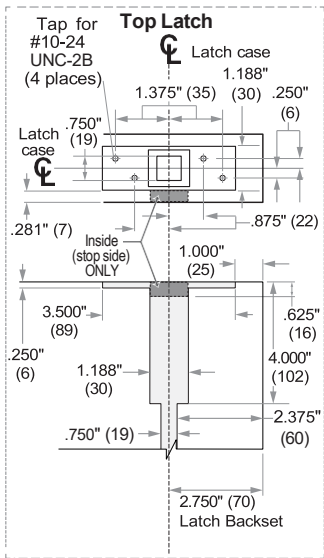

39.625" (100.6 cm)
 to finished floor

.750" (19) Bottom cable routing

(excl

ude for LBL application)

Dimensions shown in
parentheses () are in millimeters.

© 2021 Allegion
L951 Rev. 12/21

DRAWING IS NOT TO SCALE!
Customer service: 877-671-7011
**We can help you find the correct guide
for**

Door preparation template

L951

LM9200-Series

Models LM9271, LM9271M Locks

ALLEGION™

Door Type: Metal, flat or beveled
 Trim: Rose

For case and strike dimensions, see Template L3.

NOTES:

Suitable reinforcement required for metal door installation.
For fire-rated locks less bottom latch (LBL), refer to
template #L960 for additional door preparation instructions.

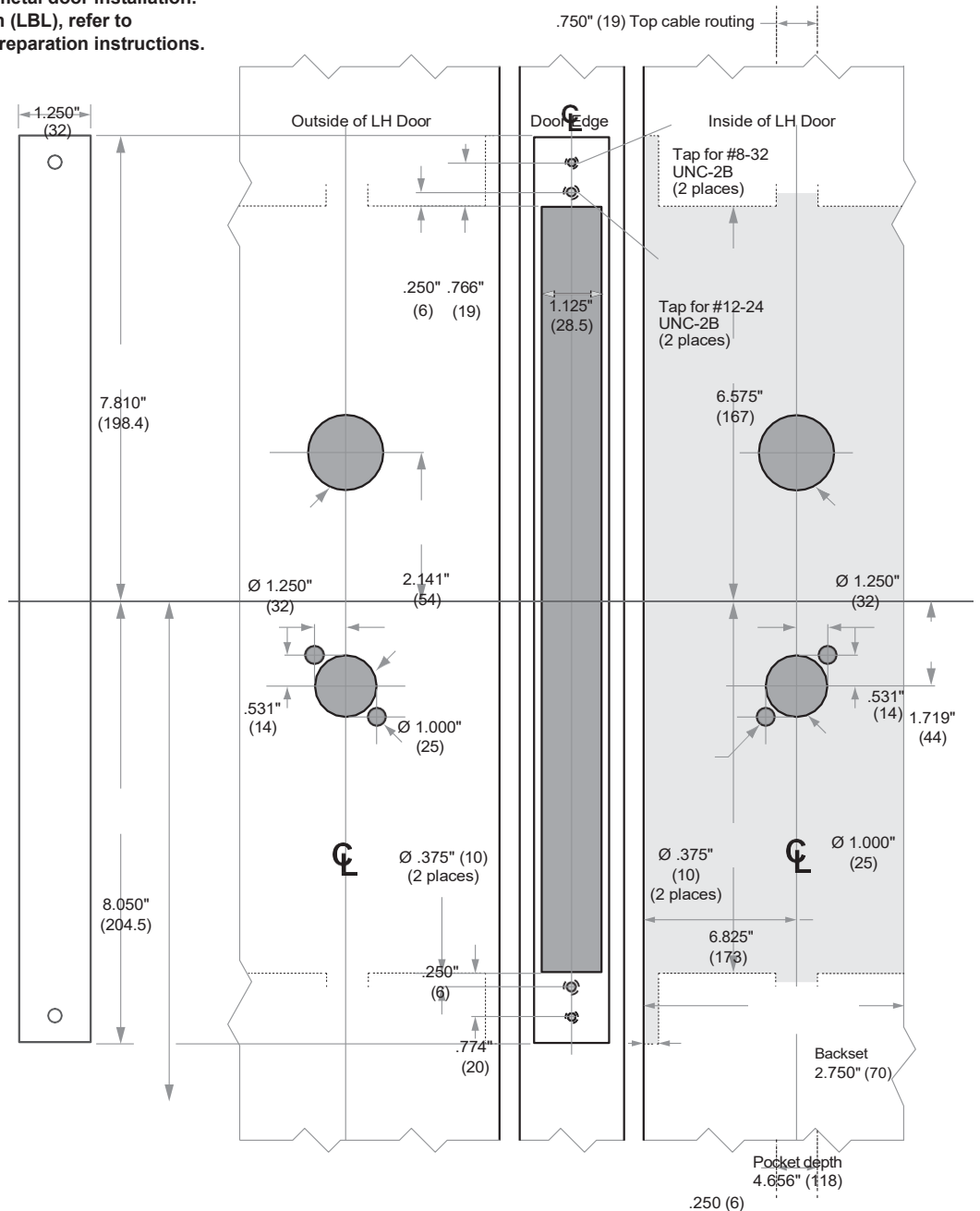
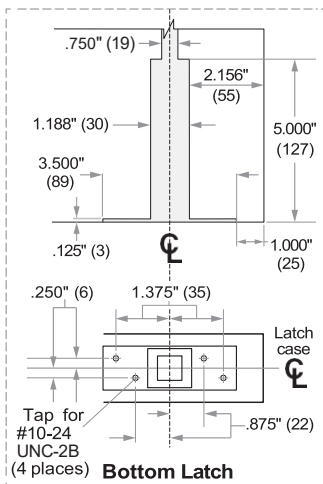
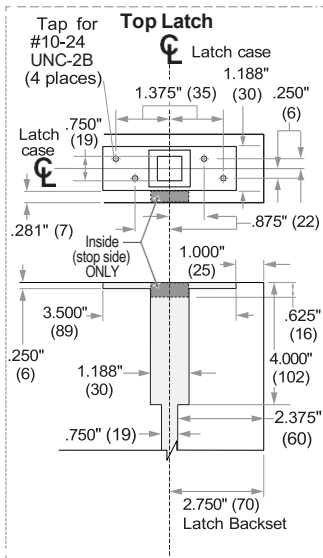

Armor Front

39.625" (100.6 cm)
 to finished floor

.750" (19) Bottom cable routing

(exclud
e for

LBL application)

Dimensions shown in
parentheses () are in millimeters.

© 2021 Allegion
L952 Rev. 12/21

DRAWING IS NOT TO SCALE!
Customer service: 877-671-7011
**We can help you find the correct guide
for**

Door preparation template

L952

LM9200-Series

ALLEGION™

Models LM9290EL/EU, LM9290M EL/EU, LM9291 EL/EU, LM9291M EL/EU Locks

Door Type: Metal, flat or beveled

Trim: Escutcheon

For case and strike dimensions, see Template L3.

NOTES:

Suitable reinforcement required for metal door installation.

For fire-rated locks less bottom latch (LBL), refer to

template #L960 for additional door preparation instructions.

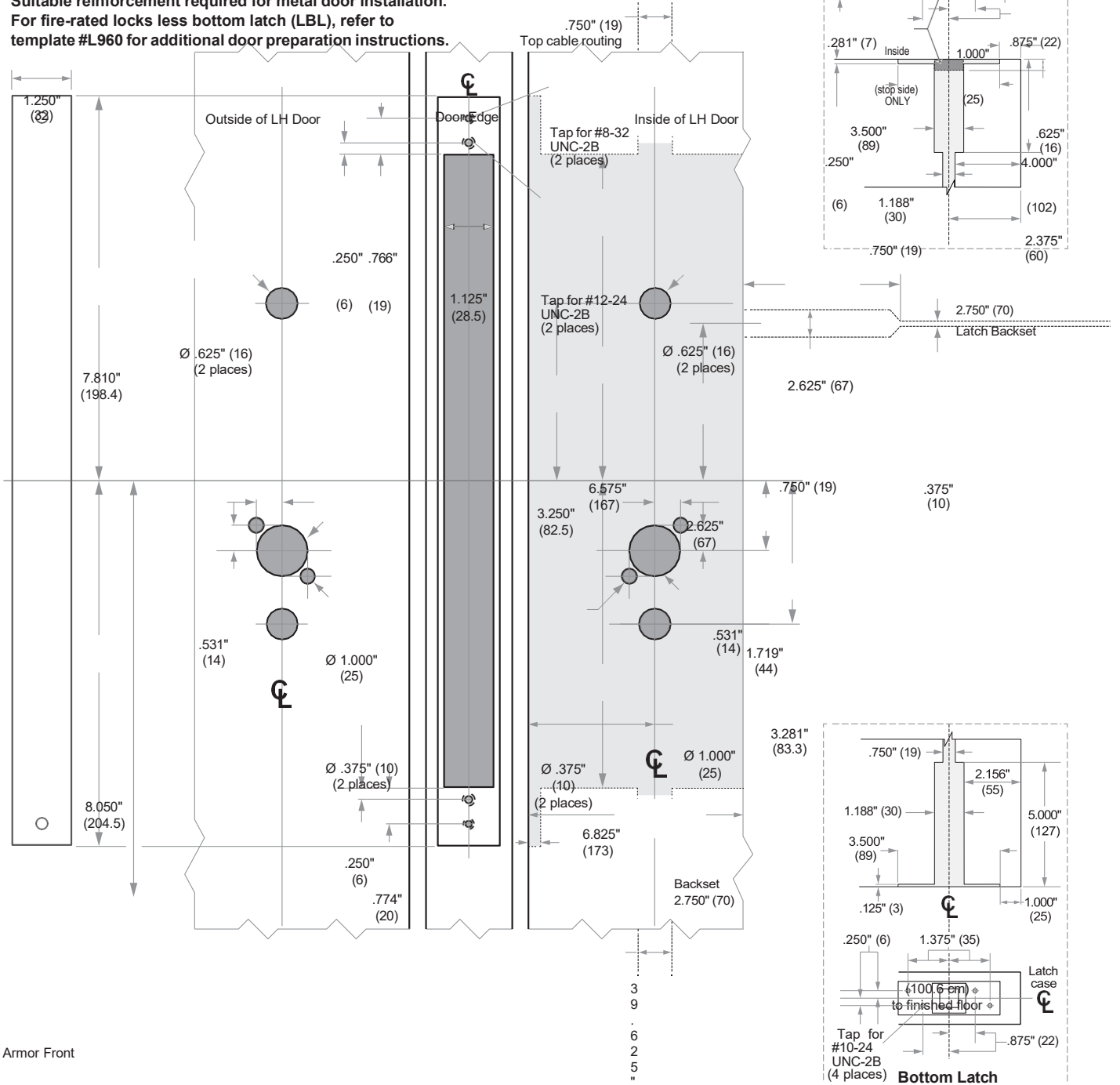

.250 (6)

P
o
c
k
e
t
d
e
p
t
h
4
.
6
5
6
"
(
1
1
8
)

.750" (19) Bottom cable routing
(exclude for LBL application)

Dimensions shown in
parentheses () are in millimeters.

© 2021 Allegion
L953 Rev. 12/21

DRAWING IS NOT TO SCALE!
Customer service: 877-671-7011
**We can help you find the correct guide
for**

Door preparation template
L953

LM9200-Series

ALLEGION™

Models LM9290EL/EU, LM9290M EL/EU, LM9291 EL/EU, LM9291M EL/EU Locks

Door Type: Metal, flat or beveled

Trim: Rose

For case and strike dimensions, see Template L3.

NOTES:

Suitable reinforcement required for metal door installation.
For fire-rated locks less bottom latch (LBL), refer to template #L960 for additional door preparation instructions.

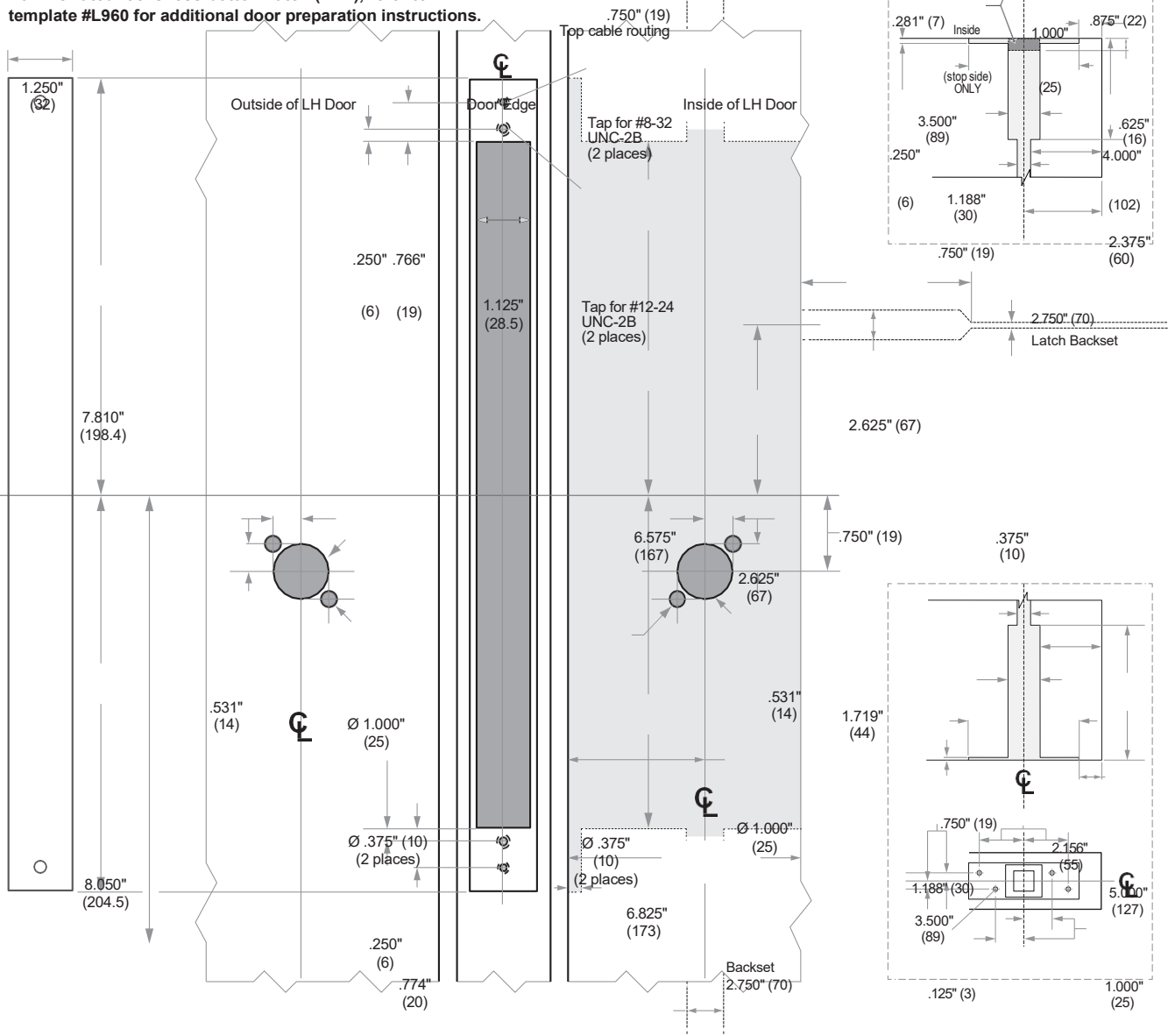

3	"	c	n	loor
9	()	i	
.	0	t	s	
6	0	f	h	
2	.	i	e	
5	6		d	
			f	

.250 (6)

Pocket depth
4.656" (118)

.250"
(6)

1.375" (35)

L
a
t
c
h
c
a
s
e

Bottom Latch

.875" (22)

T
a
p
f
o
r

1
0
-
2
4
U
N
C
-
2
B
(
4
p
l
a
c
e
s)

.750" (19) Bottom cable routing
(exclude for LBL application)

Dimensions shown in
parentheses () are in millimeters.

© 2021 Allegion
L954 Rev. 12/21

DRAWING IS NOT TO SCALE!
Customer service: 877-671-7011
**We can help you find the correct guide
for**

Door preparation template

L954

LM9200-Series

ALLEGION™

Models LM9292EL/EU, LM9292M EL/EU, LM9293 EL/EU, LM9293M EL/EU Locks

Door Type: Metal, flat or beveled

Trim: Escutcheon

For case and strike dimensions, see Template L3.

NOTES:

Suitable reinforcement required for metal door installation.

For fire-rated locks less bottom latch (LBL), refer to template #L960 for additional door preparation instructions.

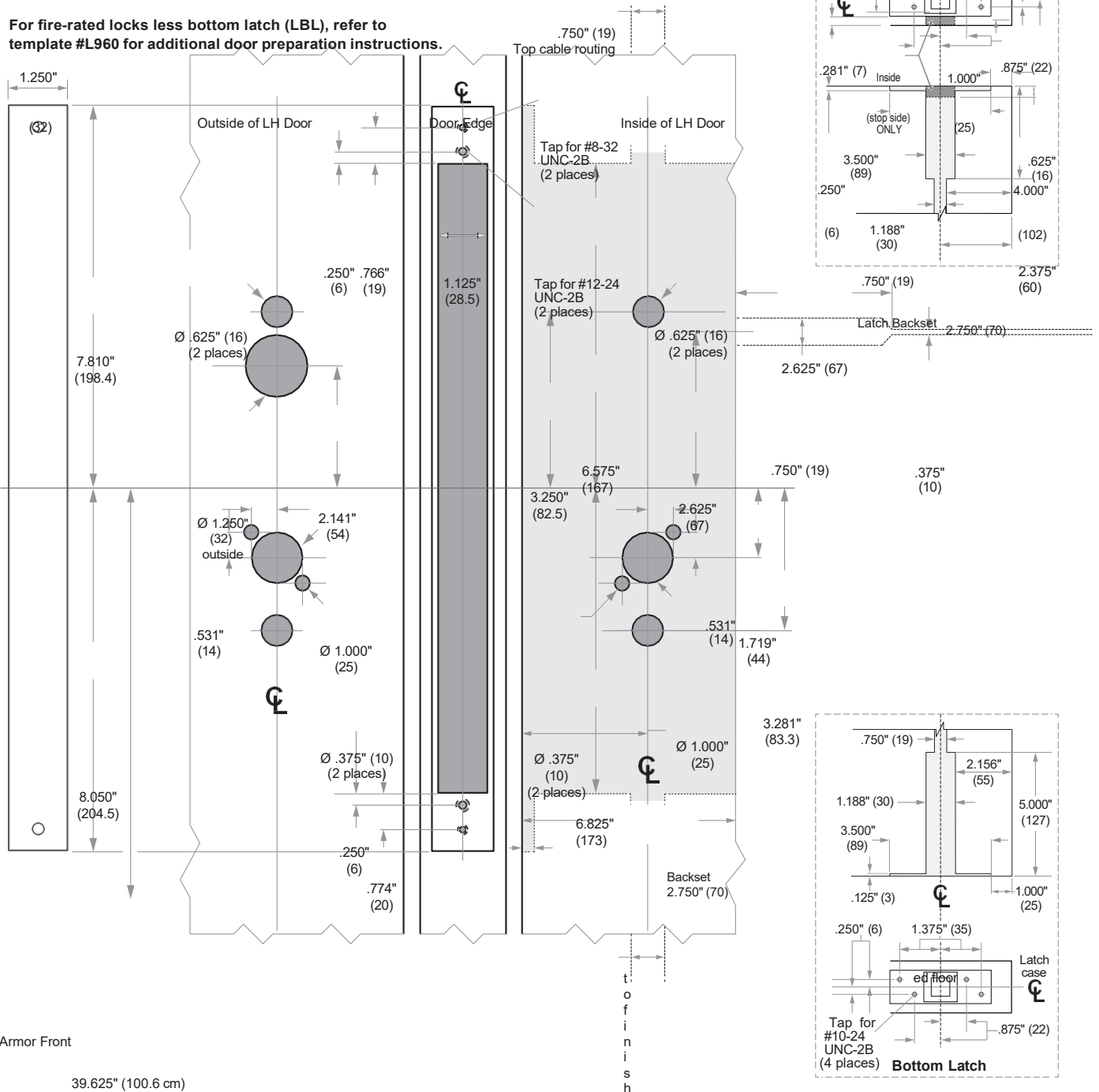

.250 (6)

P
o
c
k
e
t
d
e
p
t
h
4
.
6
5
6
"
(
1
1
8
)

.750" (19) Bottom cable routing
(exclude for LBL application)

Dimensions shown in
parentheses () are in millimeters.

© 2021 Allegion
L955 Rev. 12/21

DRAWING IS NOT TO SCALE!
Customer service: 877-671-7011
**We can help you find the correct guide
for**

Door preparation template

L955

LM9200-Series

ALLEGION™

Models LM9292EL/EU, LM9292M EL/EU, LM9293 EL/EU, LM9293M EL/EU Locks

Door Type: Metal, flat or beveled

Trim: Rose

For case and strike dimensions, see Template L3.

NOTES:

Suitable reinforcement required for metal door installation.
For fire-rated locks less bottom latch (LBL), refer to template #L960 for additional door preparation instructions.

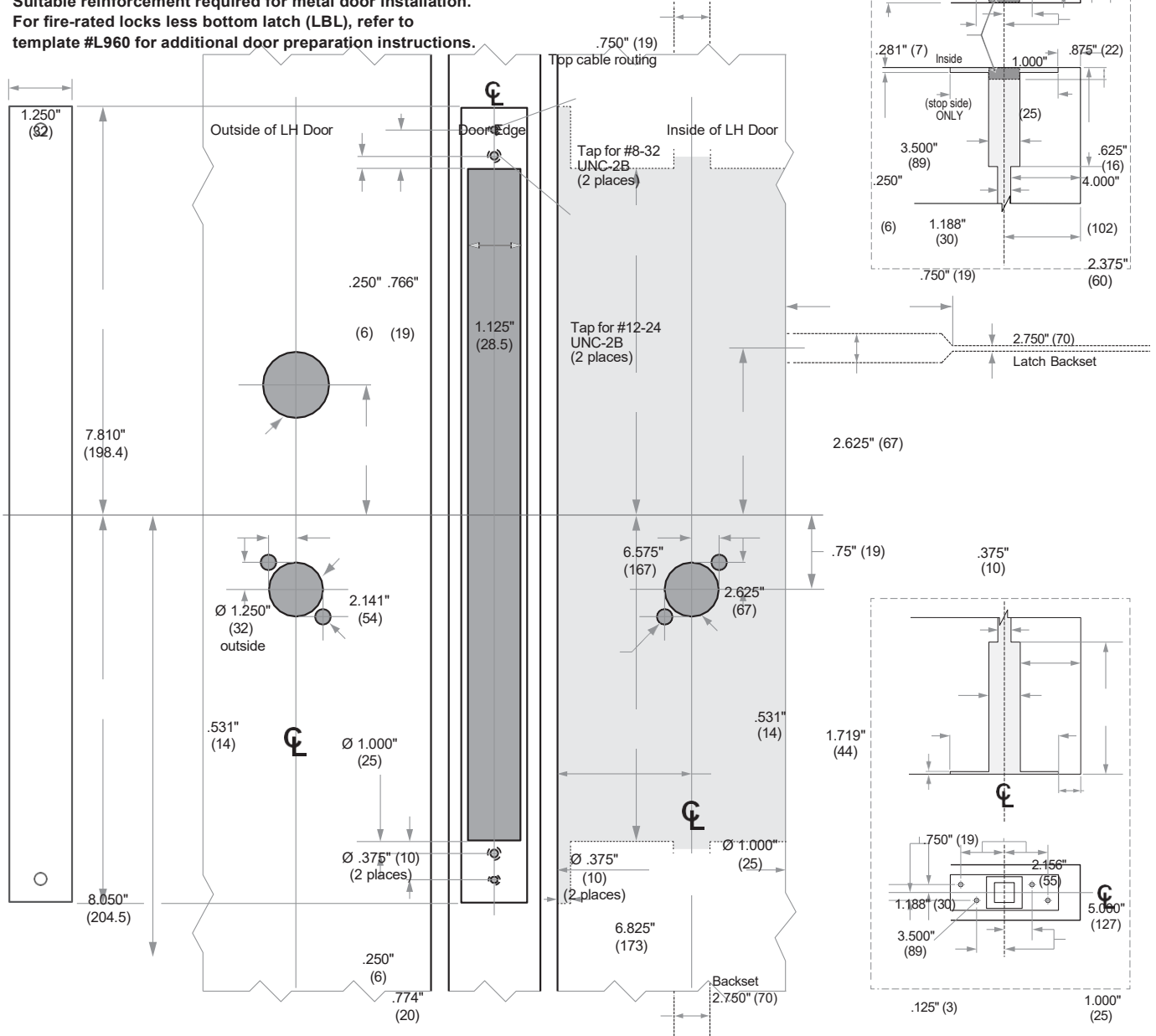

Armor	3	6	1	0.6
Front	9	2	1	(
		5	0	cm)
				to
				finish

ed floor

.250" (6) 1.375" (35)

Pocket depth
4.656" (118)
.250 (6)

Latch
case

Tap for
#10-24
UNC-2B
(4 places) **Bottom Latch** .875" (22)

.750" (19) Bottom cable routing
(exclude for LBL application)

Dimensions shown in
parentheses () are in millimeters.

DRAWING IS NOT TO SCALE!
Customer service: 877-671-7011

Door preparation template

.250 (6)

P
o
c
k
e
t
d
e
p
t
h
4
.
6
5
6
"
(
1
1
8
)

.750" (19) Bottom cable routing
(exclude for LBL application)

Dimensions shown in
parentheses () are in millimeters.

DRAWING IS NOT TO SCALE!
**Customer service: 877-671-
7011**

Door preparation template

LM9200-Series

ALLEGION™

Models LM9294EL/EU, LM9294M EL/EU, LM9295 EL/EU, LM9295M EL/EU Locks

Door Type: Metal, flat or beveled

Trim: Rose

For case and strike dimensions, see Template L3.

NOTES:
 Suitable reinforcement required for metal door installation.
 For fire-rated locks less bottom latch (LBL), refer to template #L960 for additional door preparation instructions.

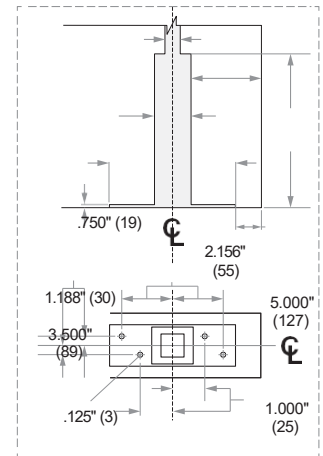
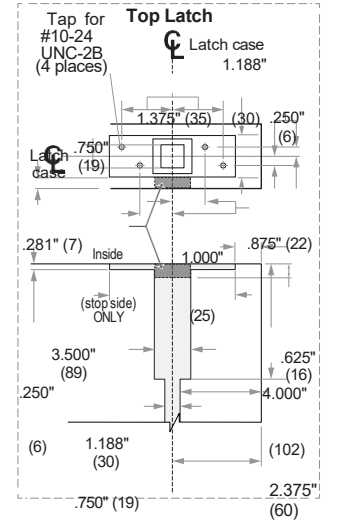
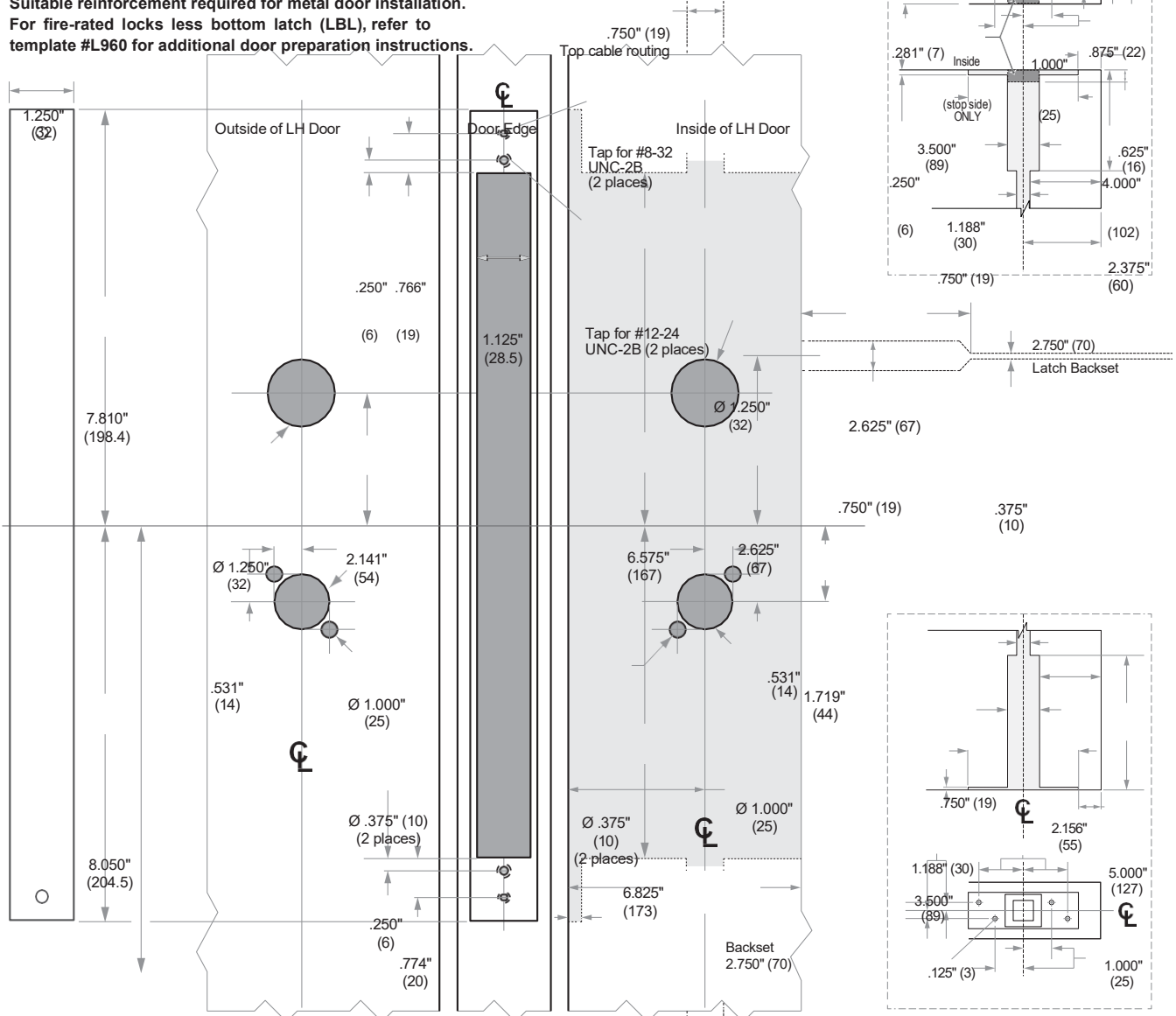

Armor Front

1
0
0
.
6
2
5
"
(
)

t
o
f
i
n
i
s
h

e
d
f
l
o
r
e

250 (6)

Pocket depth 4.656" (118)

.250" 1.375" (35)
(6)

L
a
t
c
h
c
a
s
e

Tap
for
#10-
24
UNC-
2B
(4
places)

**Bottom
Latch**

.875" (22)

.750" (19) Bottom cable routing
(exclude for LBL application)

Dimensions shown in
parentheses () are in millimeters.

DRAWING IS NOT TO SCALE!
**Customer service: 877-671-
7011**

Door preparation template

LM9200F-LBL (Less bottom latch)

Multi-Point Locks (20-minute wood door application)

ALLEGION™

Door Type: Wood or composite, flat or beveled
 Trim: Escutcheon or rose

For case and strike dimensions, see Template L3.

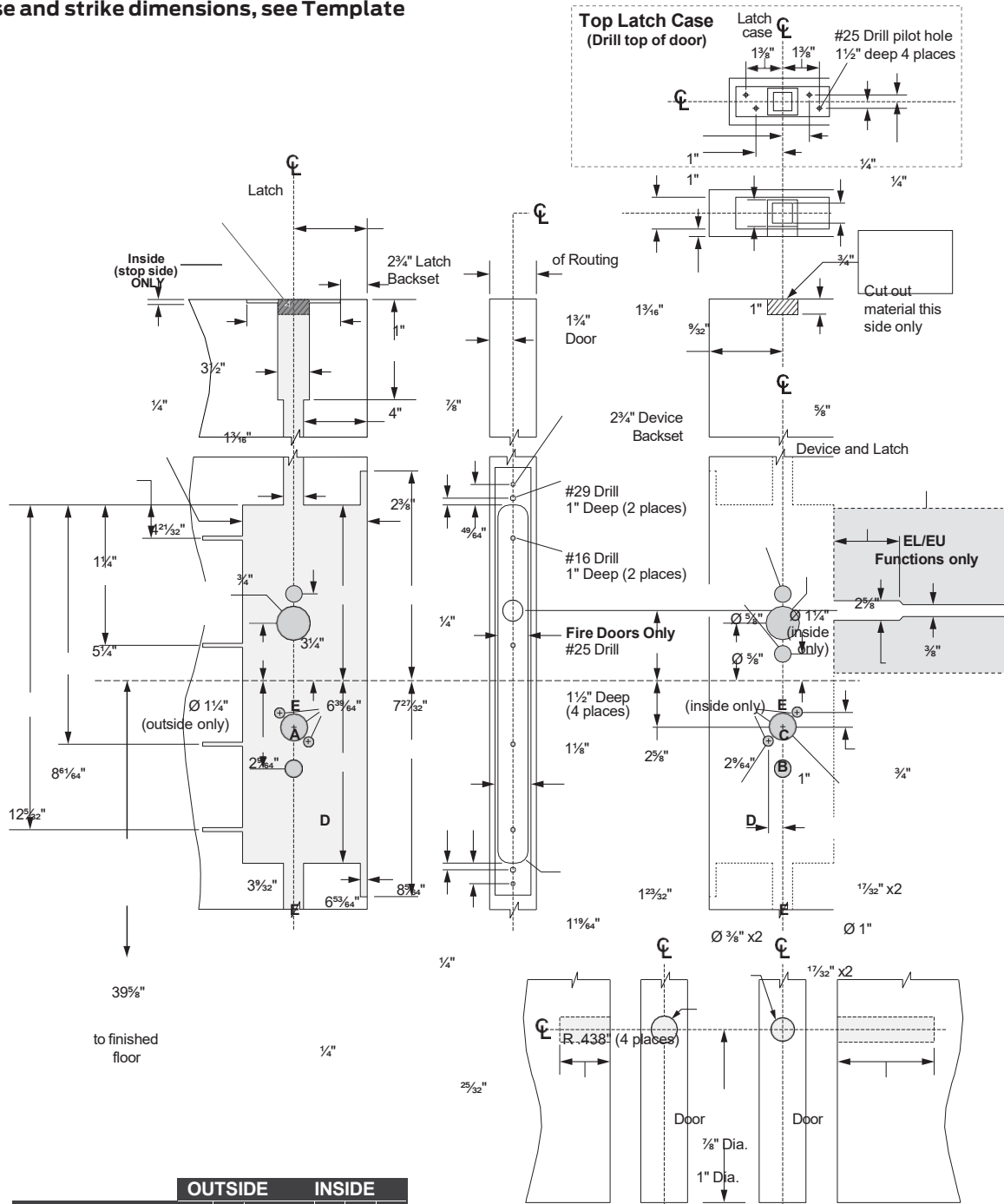

Functions	OUTSIDE			INSIDE			
	A	D	E	B	C	D	E
LM9225	No holes						
LM9210		X					X
LM9250, LM9256	X	X		X			X
LM9270, LM9280	X	X					X
LM9271, LM9294, LM9295	X	X			X		X
LM9290, LM9291		X					X
LM9292, LM9293	X	X					X

NOTE:
For additional

e Door leaf

6" from
bottom of
door

Hole depth

information on
fire door less
bottom latch
installation,
please refer
to instruction
sheet #911009.

Fire latch assembly
Door leaf

Dimensions shown in
parentheses () are in millimeters.

© 2021 Allegion
L959 Rev. 12/21

DRAWING IS NOT TO SCALE!
Customer service: 877-671-7011
**We can help you find the correct guide
for**

Door preparation template

L959

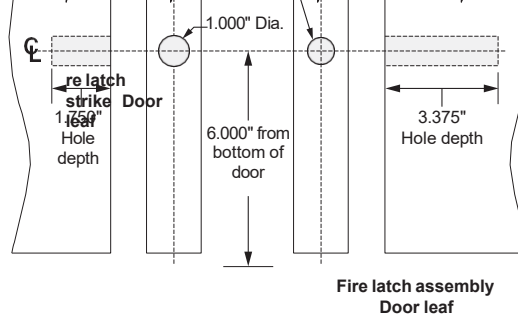

NOTE:
 For additional information on fire door less bottom latch installation, please refer to instruction sheet #911009.

Dimensions shown in parentheses () are in millimeters.

DRAWING IS NOT TO SCALE!
 Customer service: 877-671-7011

Door preparation template

L/LV/LM/LMV-Series

Models L9492, L9493 Electrified Locks

ALLEGION™

Door Type: Wood or composite, flat or beveled
Trim: Rose

This template should not be used for HSLR trim. Use template L965 for HSLR trim.

**For Case and Strike dimensions, see Template L1
Refer to Template L1 (revised October 2014 or
later) for information to prepare the door for
wire routing.**

Left Hand (LH) Door Shown

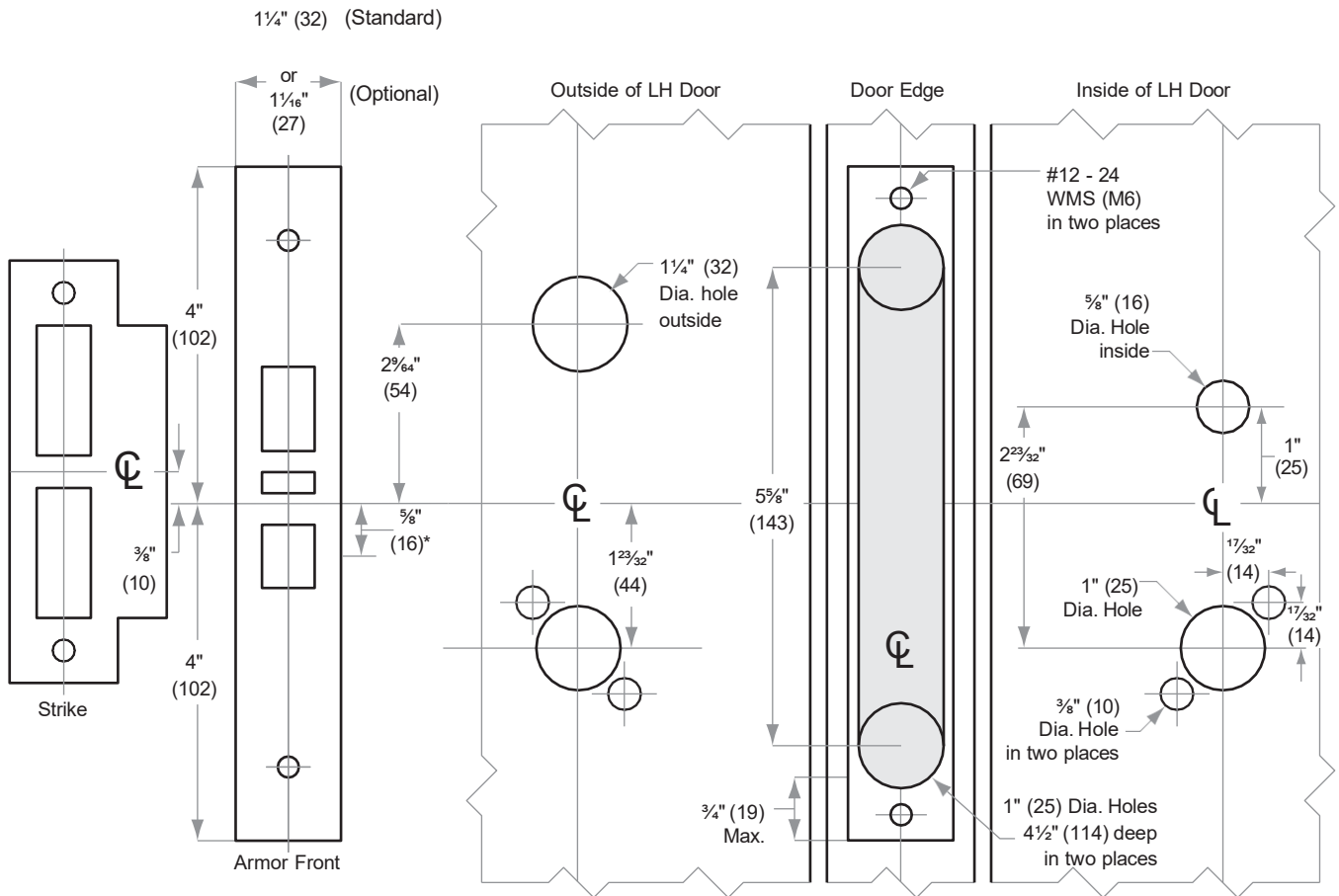

* Centerline of Armor Front to Centerline of Latch dimension

Dimensions shown in parentheses () are in millimeters.

DRAWING IS NOT TO SCALE!

Customer service: 877-671-7011

Door preparation
template

L/LV/LM/LMV-Series

Models L9492, L9493 Electrified Locks

ALLEGION™

Door Type: Metal, flat or beveled
 Trim: Rose

This template should not be used for HSLR trim. Use template L966 for HSLR trim.

**For Case and Strike dimensions, see Template L1
 Refer to Template L1 (revised October 2014 or
 later) for information to prepare the door for
 wire routing.**

Left Hand (LH) Door Shown

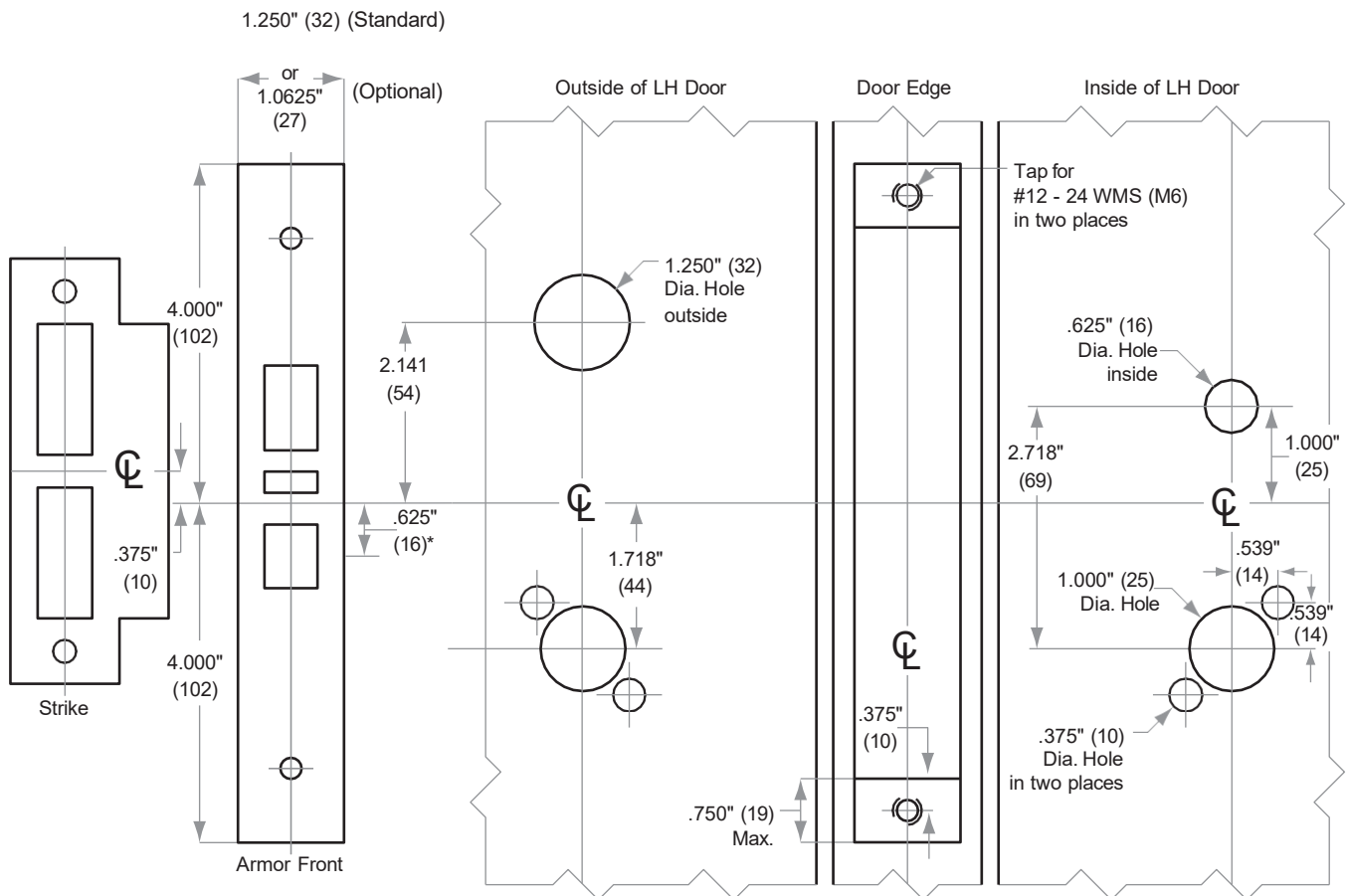

* Centerline of Armor Front to Centerline of Latch dimension

Dimensions shown in parentheses () are in millimeters.

DRAWING IS NOT TO SCALE!

Customer service: 877-671-7011

Door preparation
template

L/LV/LM/LMV-Series

Models L9492, L9493 Electrified Locks

ALLEGION™

Door Type: Wood or composite, flat or beveled
Trim: Escutcheon

This template should not be used for HSLR trim. Use template L965 for HSLR trim.

**For Case and Strike dimensions, see Template L1
Refer to Template L1 (revised October 2014 or
later) for information to prepare the door for
wire routing.**

Left Hand (LH) Door Shown

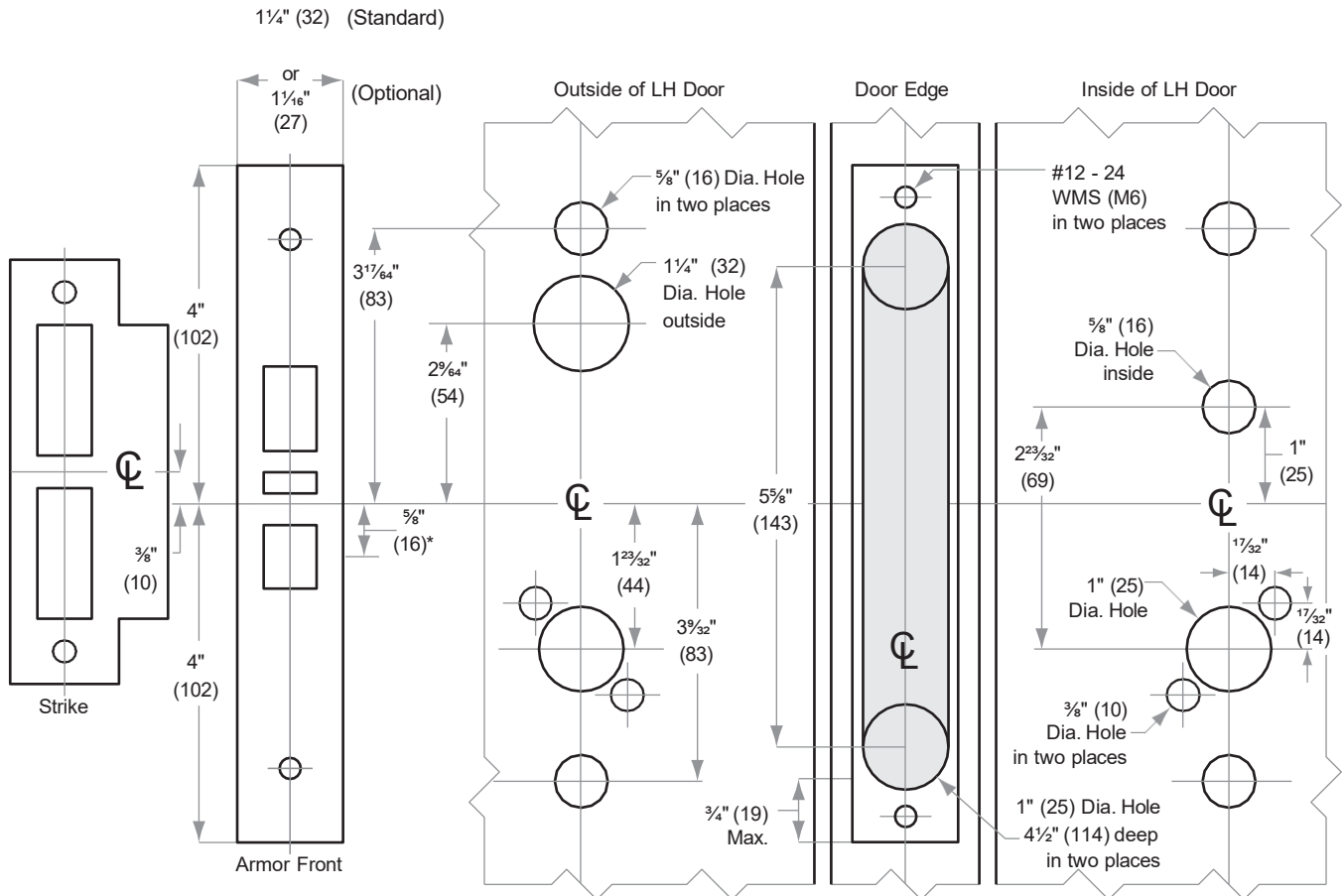

* Centerline of Armor Front to Centerline of Latch dimension

Dimensions shown in parentheses () are in millimeters.

DRAWING IS NOT TO SCALE!

Customer service: 877-671-7011

Door preparation
template

L/LV/LM/LMV-Series

Models L9492, L9493 Electrified Locks

ALLEGION™

Door Type: Metal, flat or beveled
 Trim: Escutcheon

This template should not be used for HSLR trim. Use template L966 for HSLR trim.

**For Case and Strike dimensions, see Template L1
 Refer to Template L1 (revised October 2014 or
 later) for information to prepare the door for
 wire routing.**

Left Hand (LH) Door Shown

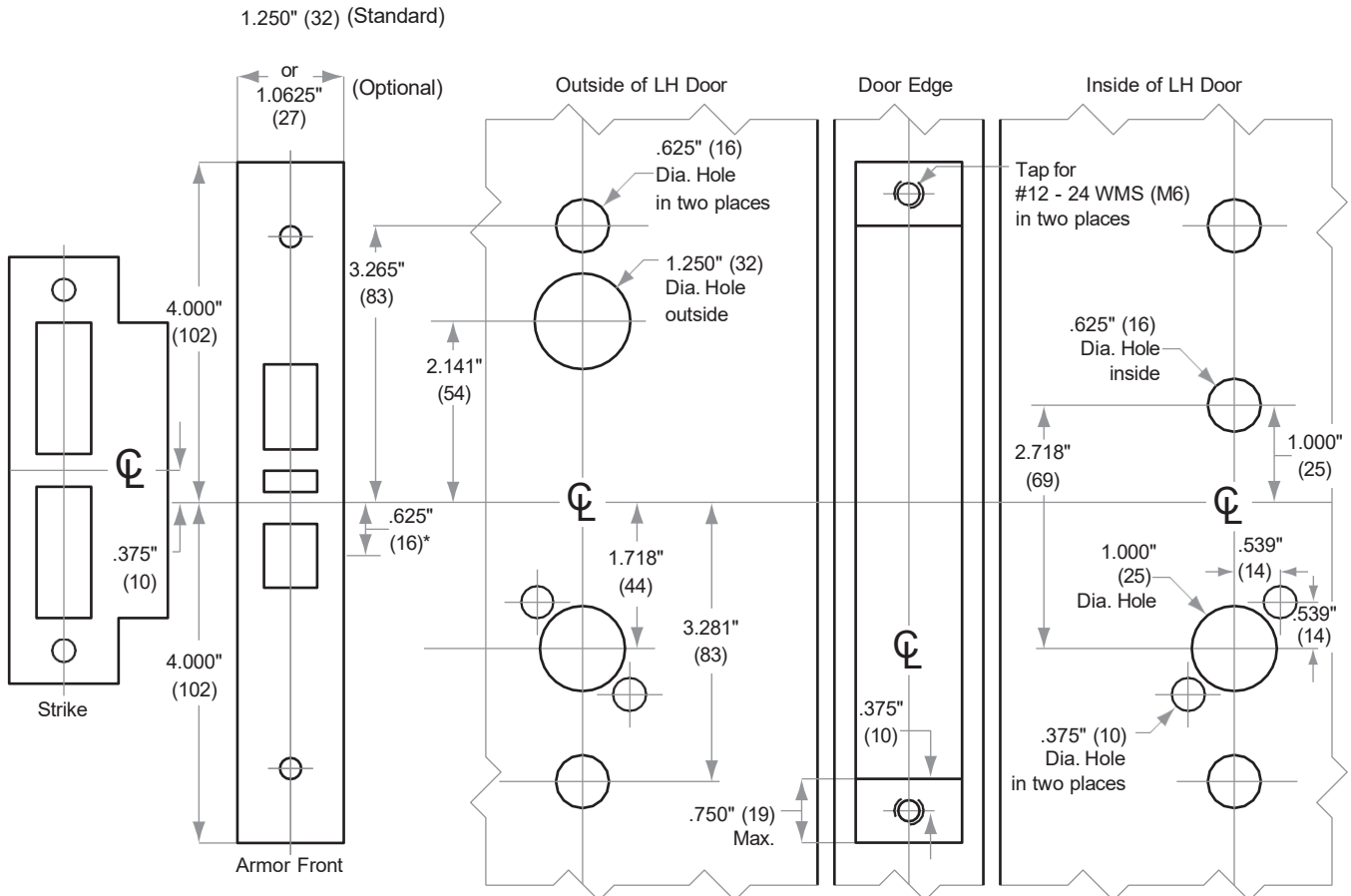

* Centerline of Armor Front to Centerline of Latch dimension

Dimensions shown in parentheses () are in millimeters.

DRAWING IS NOT TO SCALE!

Customer service: 877-671-7011

Door preparation
template

L9000-Series HSLR

ALLEGION™

Door Type: Wood or Composite, Flat or beveled
Trim: Escutcheon

For case and strike dimensions, see Template [L4](#).

LH door shown

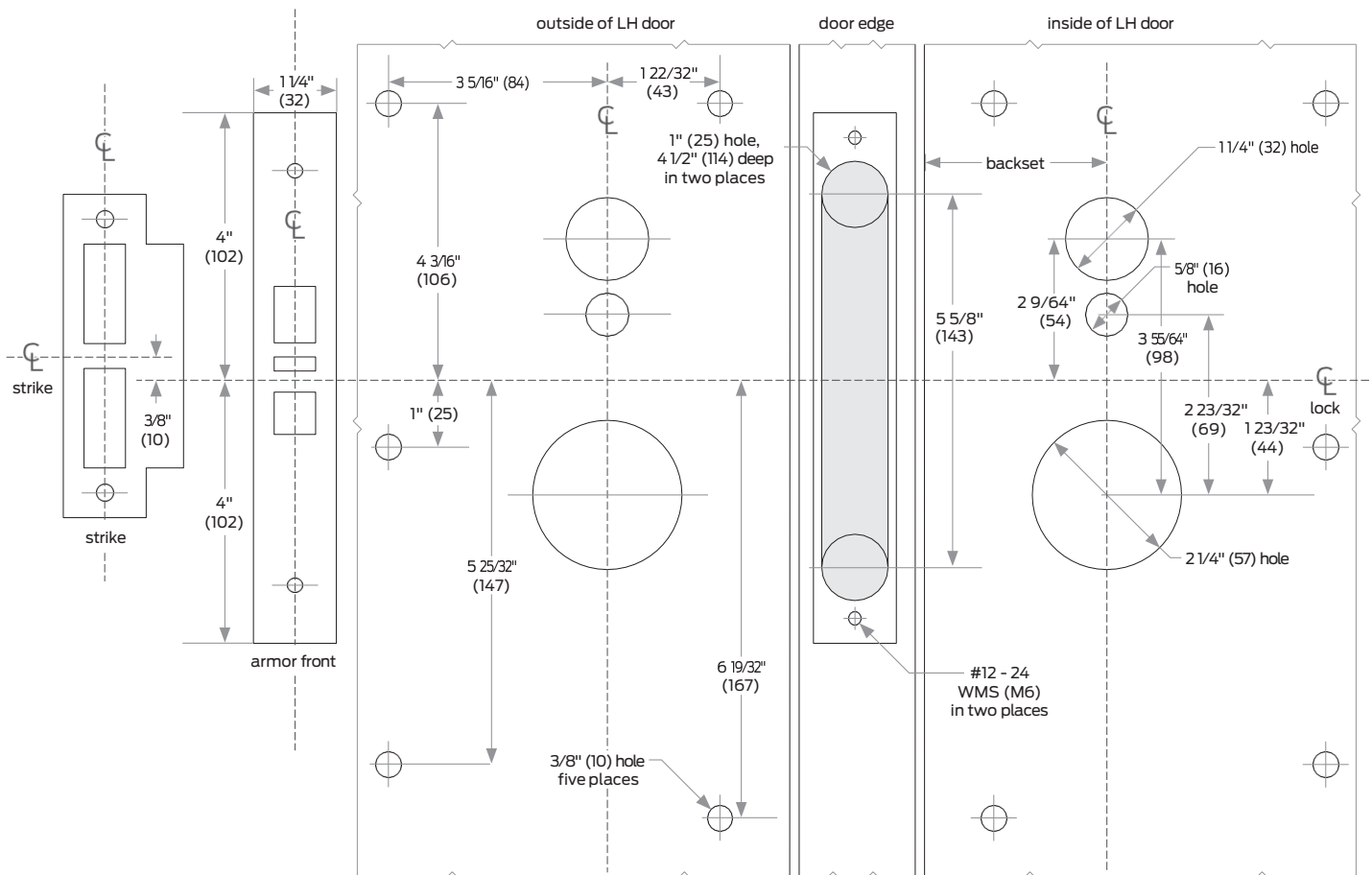

Dimensions shown in parentheses () are in millimeters.

DRAWING IS NOT TO SCALE!
Customer service: 877-671-

7011

Door preparation
template

L9000-Series HSLR

ALLEGION™

Door Type: Metal, Flat or beveled
 Trim: Escutcheon

For case and strike dimensions, see Template [L4](#).

LH door shown

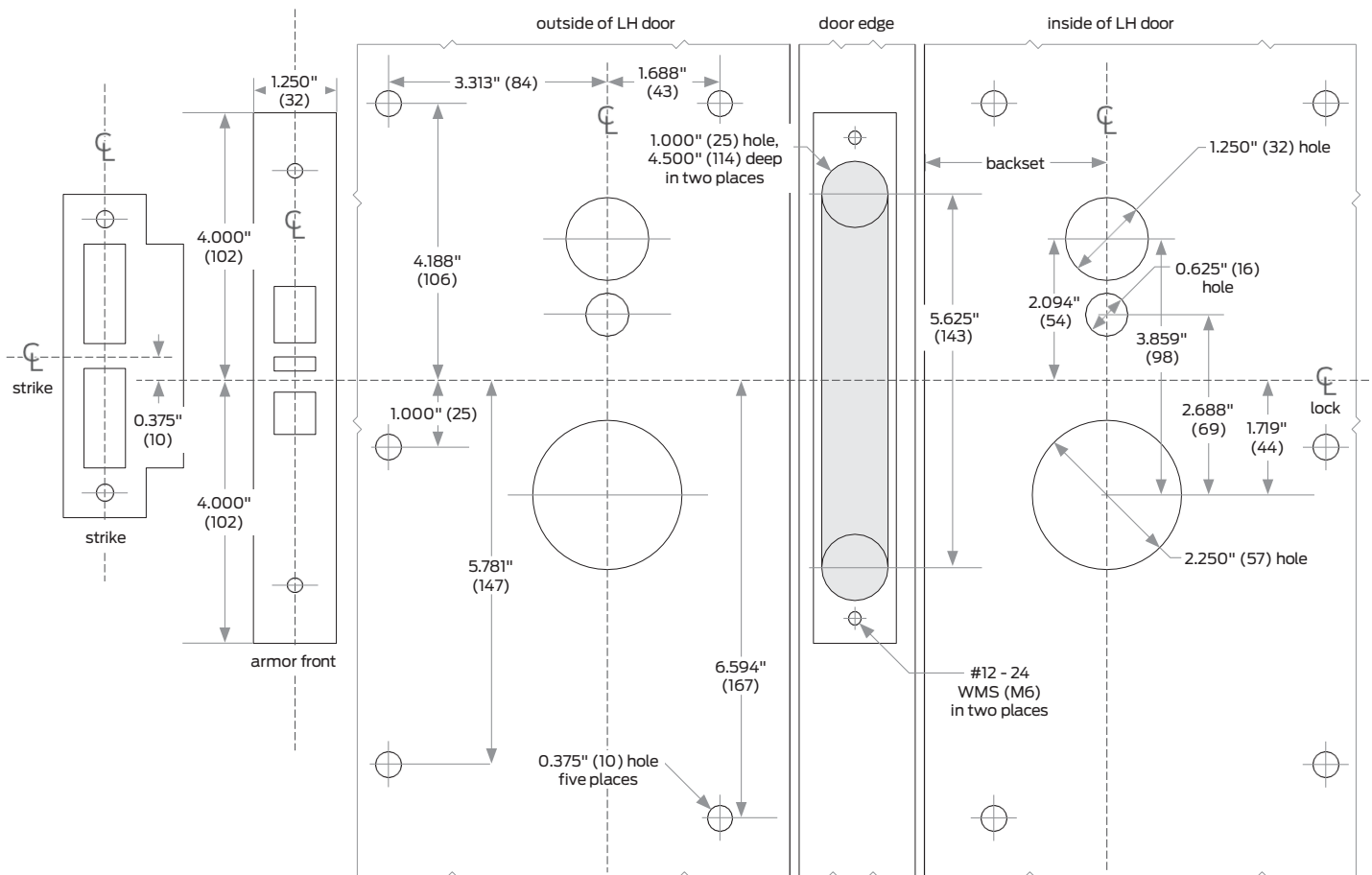

Dimensions shown in parentheses () are in millimeters.

DRAWING IS NOT TO SCALE!
 Customer service: 877-671-

7011

Door preparation
template

L/LV/LM/LMV-Series

Model L9412

ALLEGION™

Door Type: Wood or composite, flat or beveled
Trim: Rose

For Case and Strike dimensions, see Template L1

Left Hand (LH) Door Shown

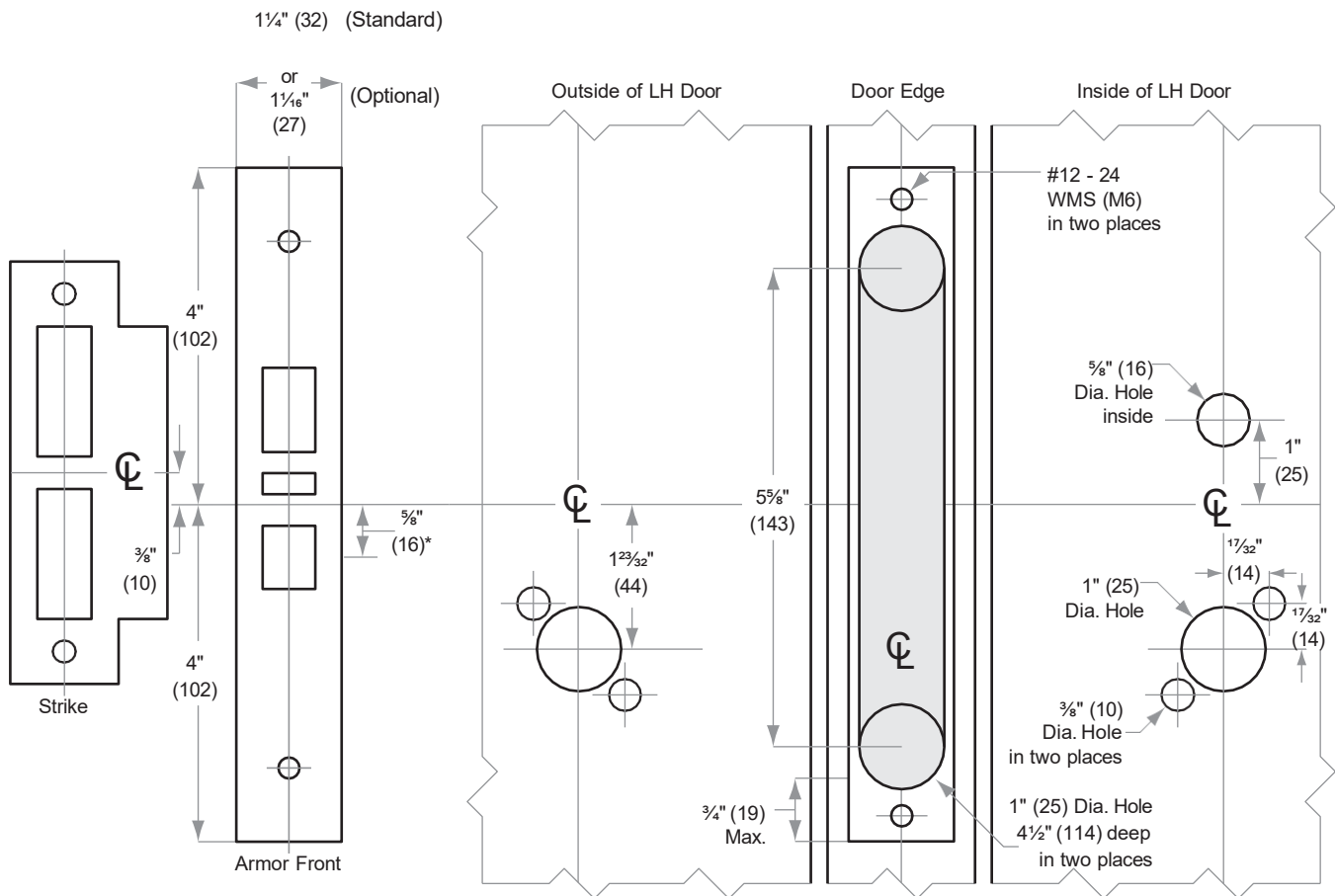

*Centerline of Armor Front to Centerline of Latch dimension

Dimensions shown in parentheses () are in millimeters.

DRAWING IS NOT TO SCALE!

Customer service: 877-671-7011

Door preparation
template

L/LV/LM/LMV-Series

Model L9412

ALLEGION™

Door Type: Metal, flat or beveled
 Trim: Rose

For Case and Strike dimensions, see Template L1

Left Hand (LH) Door Shown

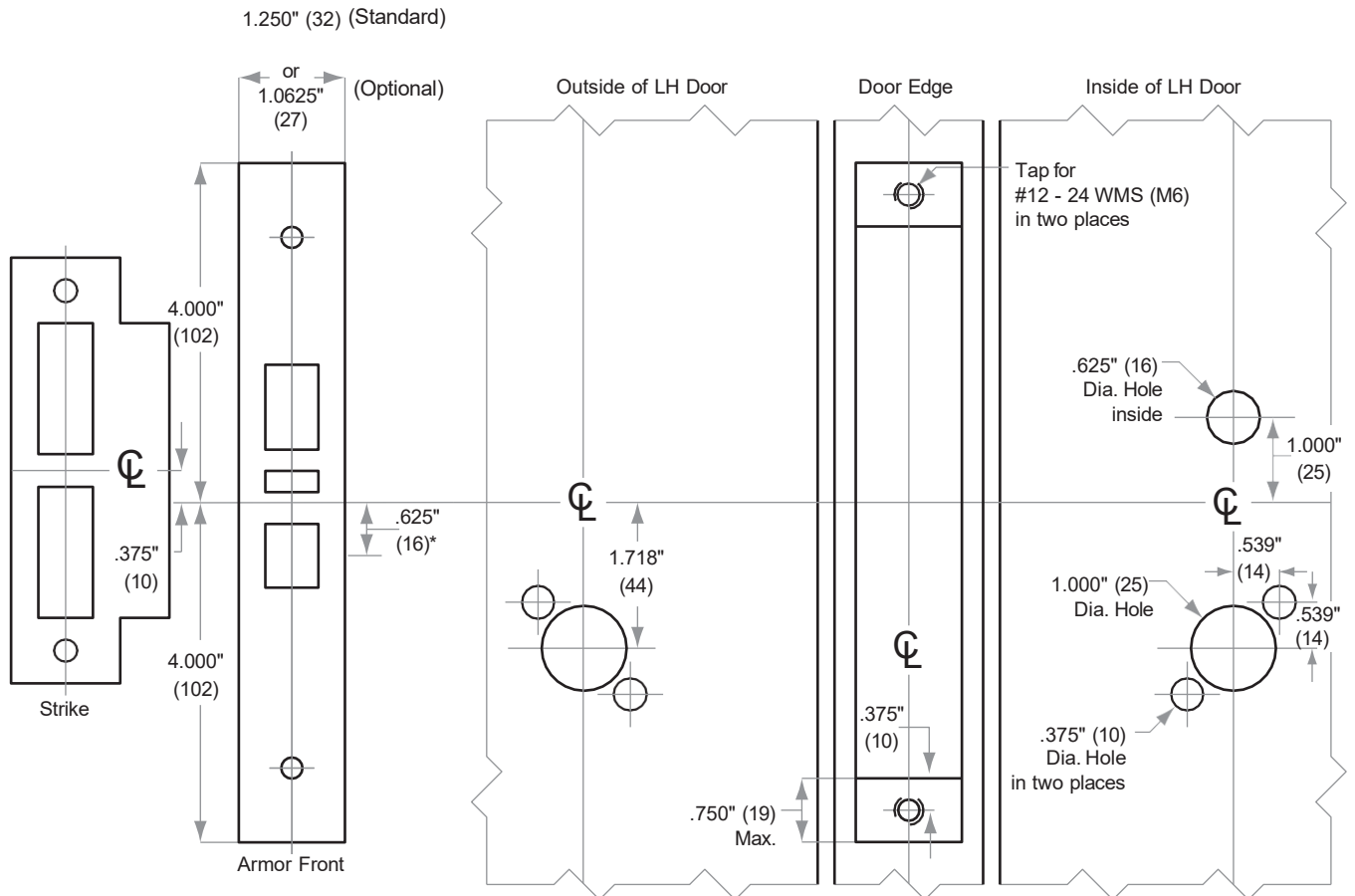

*Centerline of Armor Front to Centerline of Latch dimension

Dimensions shown in parentheses () are in millimeters.

DRAWING IS NOT TO SCALE!

Customer service: 877-671-7011

Door preparation
template